

# POWERDOT M2

## INSTRUCTION MANUAL

PowerDot M2 user manual  
Rev. 1.0.0a (Feb 2022)





# YOUR POWERDOT M2

Congratulations on getting a PowerDot M2 device! Your PowerDot PD-01M2 uses electrical muscle stimulation (EMS, also known as neuromuscular electrical stimulation or NMES) and transcutaneous electrical nerve stimulation (also known as TENS) technologies to stimulate your muscles and nerves for therapeutic purposes. You can operate your PowerDot wirelessly using the companion PowerDot Patient application on your phone.

## INDICATIONS FOR USE

PowerDot PD-01M2 stimulator is intended to be used under the direction of a physical therapist, athletic trainer, caregiver, or healthcare provider.

The device can be either used by the therapist in healthcare facility setting (when operated from PowerDot Doctor mobile application) or by patient/lay operator in a home environment (when operated from PowerDot Patient mobile application).

PowerDot PD-01M2 has the following indications for use:

### NMES

- Slowing or preventing disuse atrophy
- Maintaining or increasing range of motion
- Re-educating muscles

- Relaxation of muscle spasms
- Increasing local blood circulation
- Prevention of venous thrombosis of the calf muscles immediately after surgery
- Stimulation of healthy muscles in order to improve or facilitate muscle performance

### TENS

- Symptomatic relief and management of chronic pain
- Managing post-surgical and post-trauma acute pain
- Temporary relief of pain associated with sore and aching muscles due to strain from exercise or normal household and work activities

**Caution: Federal law restricts prescription of certain stimulation programs by or on the order of a practitioner licensed by the law of the State in which he/she practices to use or order the use of prescribed programs.**

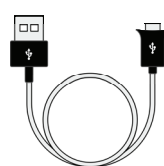
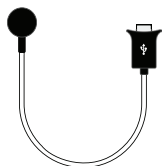
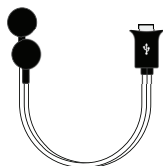
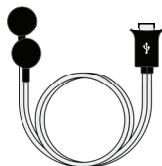
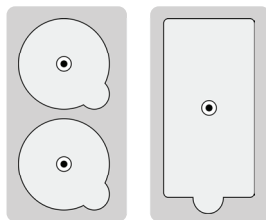

## PACKAGE CONTENTS

(from left to right)

A. **CARRY CASE**

For storing and carrying your PowerDot PD-01M2 (or two PowerDots), your electrode pads, and cables.

B. **POWERDOT PD-01M2 UNIT** (Pod)  
Generates and sends electrical signals via electrode pads to your muscles and nerves.

C. **ROUND/RECTANGULAR ADHESIVE ELECTRODE PADS**

Self-adhesive electrode pads that connect to the lead cables via magnetic connectors. NOTE: always follow the pad placement instructions from the PowerDot App or within this manual.

D. **USB CHARGING CABLE**

For charging and recharging PowerDot pods. (Pods come charged; battery life is shown on the mobile app).

E. **LEAD CABLES** (Electrode Cables)

Used to transmit electrical signals from the pods to electrode pads. PowerDot lead cables are either 6" (15 cm) or 18" (45 cm) long. Depending on the muscle group or body area you are targeting, and your own physique, you can use either of these cables. For example, in most cases the 6" lead cable will suffice for abdominal muscles, while the 18" lead cable will be more suitable for longer quadriceps muscles.

# WARNINGS AND SAFETY GUIDELINES

## ❶ COUNTERINDICATIONS

NEVER use PowerDot without your physician's approval if you have ANY of the following:

- Cardiac stimulator (pacemaker), implanted defibrillator or other implanted metallic or electronic device. Such use could cause electric shock, burns, electrical interference, or death.
- Epilepsy
- Cancer or cancerous lesions
- Any heart problem or condition
- Pregnancy
- Abdominal or inguinal hernia

## ❷ SAFETY MEASURES

- Do not recharge PowerDot when it is attached to electrodes or any part of your body.
- Do not apply near the area of an implant, such as cochlear implants, pacemakers, electrical or skeletal anchorage implants or any other active implanted or body worn devices. Such use could cause electric shock, burns, implantable/body worn device malfunction due to electrical interference, or death.
- Do not apply near metal. Remove jewelry, body piercings, belt buckles or

any other removable metallic product or device in the area of stimulation.

- If pregnant, do not place electrodes directly over the uterus or connect pairs of electrodes across the abdomen.
- Do not use PowerDot in water (bath, shower, pool, etc.) or in a humid atmosphere (sauna, hydrotherapy, etc.).
- Do not use PowerDot in an oxygen-rich atmosphere, such as operating rooms.
- Do not connect pods, leads, or pads to any other objects.
- During a PowerDot session, do not disconnect electrodes when running. Stop the session first.
- Do not use the PowerDot while driving, operating machinery, cycling or during any activity in which electrical stimulation can put you at risk of injury.
- Do not apply while sleeping.
- Do not allow movement resulting from muscular contraction during a session. You should try to always stimulate muscles in an isometric way; this means that the extremities of the limb in which a muscle is being stimulated must be firmly fixed, so as to prevent any movement resulting from contraction.
- Keep PowerDot device and its accessories out of reach of children and pets. Do not allow any foreign objects (soil, water, metal, etc.) to get into any part of the device.
- Sudden temperature changes can cause condensation to build up inside the

stimulator. Only use the device once it has reached ambient temperature.

- Do not exert yourself when using electrical muscle stimulation. I.e., PowerDot is meant for use after workouts, never during.
- Do not use the stimulator at altitudes of over 1.75 miles (9842 feet, or 3000 meters).
- Do not use PowerDot if you are connected to a high-frequency surgical instrument, as this could cause skin irritations or burns under the electrodes.
- Do not use PowerDot in areas where unprotected devices are used to emit electromagnetic radiation. Portable communications equipment, RFID and electromagnetic security systems (e.g., metal detectors and EAS) can interfere with PowerDot and alter the current generated by it.



*Some RF emitters, such as RFID systems, might not be visible to you. If you experience unexpected change in stimulation intensities, please terminate stimulation immediately, as advised in section “6. Terminating Stimulation” of this User Manual.*

- Do not use PowerDot in close proximity of medical devices such as MRI, CT, diathermy, X-Ray as those could alter the current generated by the PowerDot and possibly cause tissue damage, resulting in severe injury or death. If you

have any doubts when using PowerDot stimulator in close proximity to another medical device, please contact the device manufacturer or your doctor.



*PowerDot is an MR unsafe device. Do not use PowerDot PD-01M2 near, on, or in in the MRI scanner (magnet) room.*

### **3 PAD PLACEMENT PRECAUTIONS**

NEVER attach electrode pads:

- Near or to your head, as the effects of NMES and TENS stimulation on the brain are unknown.
- On the front and sides of the neck or mouth, as this could cause severe muscle spasms resulting in closure of your airway, difficulty in breathing, or adverse effects on heart rhythm or blood pressure.
- Across your chest, as the introduction of electrical current into the chest may cause rhythm disturbances to your heart, which could be lethal.
- Simultaneously to your front torso (i.e., chest or abs) and back torso (i.e. upper back, lower back). You may, of course, use PowerDot on those muscle groups, but never at the same time. Work your front torso and your back torso separately.
- Over open wounds or rashes, or over swollen, red, infected, or inflamed

areas or skin eruptions (e.g., phlebitis, thrombophlebitis, varicose veins).

- Over, or in proximity to, cancerous lesions.

#### 4 PAD USAGE PRECAUTIONS

- Only use electrode pads supplied by PowerDot Inc. Other electrodes may cause potential allergic reactions due poor biocompatibility, or have electrical properties that are unsuitable for PowerDot PD-01M2. Replacement PowerDot electrodes can be obtained from PowerDot official distributors, authorized resellers and/ or from PowerDot Online Store (<http://powerdot.com>).
- Do not immerse the pads in water.
- Do not apply solvents of any kind to the pads.
- Do not attempt to place pads on any part of the body that you yourself cannot see without assistance. E.g., on your back without a mirror to view placement.
- For best results, wash and clean your skin and dry it completely before attaching the pads.
- When attaching the pads, please ensure that the entire surface of the pad is in contact with the skin.
- For hygienic reasons, each patient must have his/her own set of pads. Do not use the same pads on different people.
- Never use a set of adhesive pads for more than 20 stimulation sessions

as their bonding power deteriorates overtime and optimal contact is very important for both patient comfort and stimulation efficacy.

- Use caution if stimulation is applied over areas of skin that lack normal sensation.
- Use caution if you may have internal bleeding, such as following an injury or fracture.

#### 5 ADVERSE REACTIONS

- Some people with very sensitive skin may experience redness under the pads after the stimulation session. Generally, this redness is completely harmless and disappears after 15 to 20 minutes. However, avoid starting a stimulation session on the same area until the redness is no longer visible.
- You may experience headaches and other painful sensations during or following the application of electrical stimulation near your eyes and to your head and face.

**WARNING: Stop using PowerDot and consult with your physician if you experience ANY adverse reactions.**

## POWERDOT PD-01M2 DEVICE & ACCESSORIES

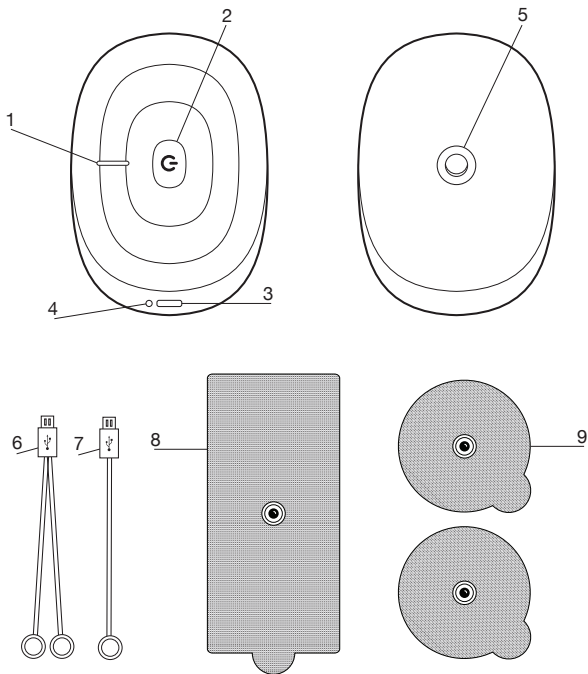

1. Power/Stimulation indicator
2. Multifunction button
3. Micro USB connector (dual function: connects either leads or charging cable)
4. Charging indicator (lights while charging)
5. Female magnetic pad connector
6. Lead cable with two female magnetic connectors
7. Lead cable with one female magnetic connector
8. Rectangular pad with male magnetic connector
9. Round pads with male magnetic connector



## POWER/STIMULATION INDICATOR ❶:

Can be either **WHITE** (when the PowerDot is on or on standby mode) or **YELLOW** (when it's being used for stimulation. Yellow lamp was chosen due to the output could be more than 10mA or 10V or 10mJ while using into a load resistance of 1000Ω).

## MULTIFUNCTION BUTTON ❷ MODES:

Multifunction Button carries out these PowerDot functions:

Multi-function Button Action	PowerDot Initial State	PowerDot Resulting State
Hold for -1 second	PowerDot is <b>OFF</b> (no lights)	PowerDot is now <b>ON</b> (white light is on)
Hold for -1 second	PowerDot is <b>ON</b> (white light is on)	PowerDot is now <b>OFF</b> (no lights)
Quick Click	PowerDot is in Stimulation (yellow light is <b>ON</b> )	Stimulation stops (yellow light is <b>ON</b> )
Hold for 5 seconds	Device is <b>ON</b>	Full Factory Reset: activation lock is released, Power LED turns <b>OFF</b> . After a few seconds, it turns ON again, blinks several times and PowerDot turns <b>OFF</b> .
Hold for 3 seconds	Device is <b>OFF</b>	Soft Reset: Activation lock is released, Power LED blinks several times.

## MICRO-USB CONNECTOR ❸:

PowerDot uses the same high voltage micro-USB connector (3) for lead cable connection and for charging.

If the device is being used for stimulation, it will immediately stop once the lead cables are disconnected from the micro-USB connector.

## CHARGING INDICATOR ❹:

While the device is still charging, you will see the **ORANGE** Charging Indicator (4) next to the micro-USB charging connector. Refer to the Recharging PowerDot section below for more information on PowerDot charging.

## SNAP CONNECTOR ❺:

Used to attach and hold the PowerDot device in place on the rectangular pad.

## LEAD CABLE ❻,❼:

For an easier, more comfortable PowerDot session, two lead cables of different lengths (6"/15cm) and 18"/45cm) (6,7) are provided with each PowerDot. These give you the option to choose the right cable to reach the muscle group you're targeting, depending on your physique.

## ELECTRODE PADS (❸,❹):

PowerDot uses two types of electrode pads — a pair of 2.2"/5.5cm round pads (9) and a 3.5x2"/9x5cm rectangular pad (8). The rectangular pad also acts as a holder for PowerDot pod.

PowerDot pads use unique skin biocompatible hydrogel with superb

conductive qualities and adhesiveness.

The lifetime of PowerDot pads depends a lot on your individual skin properties, level of hairlessness and the quality of maintenance. On average, each pad lasts for around 20 sessions. After that, adhesiveness and conductive properties of the pads may start deteriorating.



*Store your pads on the safety film in a dry environment (either in the original zipper plastic bag or inside the PowerDot carry case). Make sure you attach the pads to clean and dry skin!*

## DIRECTIONS FOR USE

### 1 INSTALLING/LAUNCHING POWERDOT APP



1. Make sure your mobile device a) runs on Android OS 6.0 or later and b) is Bluetooth -enabled.
2. Launch Google Play application; search for “PowerDot” mobile application and install.
3. Launch the installed PowerDot application, create your profile then follow instructions to locate and activate your PowerDot(s) for first use.

## iOS

1. Make sure your mobile device a) runs iOS 9.0 or later and b) is an iPhone 5 or later.
2. Launch Apple App Store application; search for “PowerDot” mobile application and install it.
3. Launch the installed PowerDot application, create your profile and then follow instructions to locate and activate your PowerDot(s) for first use.

### 2 TURNING POWERDOT ON/OFF

To turn on your PowerDot unit, hold the Multifunction Button for approximately 1 second, until you see the white power light turn on. When PowerDot is not being used for a stimulation session, you can turn it off by holding the Multifunction Button again for approximately 1 second.

When a stimulation is ongoing, click on the Multifunction Button once to stop the stimulation and then hold the Multifunction Button to turn off the PowerDot.

### 3 ACTIVATING POWERDOT

Before PowerDot can be used for muscle stimulation, it must be activated from within your PowerDot App.

When PowerDot is activated, it gets paired with your mobile phone securely. Neither you nor anyone else will be able to connect and use your PowerDot from any other mobile phone.

Follow the App's onscreen advice to scan for and activate your PowerDot(s). Make sure your PowerDot(s) is turned on before you start scanning.

Use the My Devices screen (available from the PowerDot App menu bar) to activate another or additional PowerDot device or to deactivate previously activated ones. You can activate and use up to two PowerDots at the same time.



*Remember, you won't be able to use your PowerDot(s) until you activate it with your PowerDot App on your smartphone!*

#### **4 PREPARING AND PLACING THE POWERDOT**

1. Plug the lead cable you intend to use into the micro-USB connector on your PowerDot device.

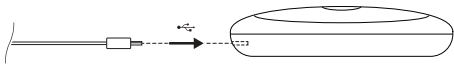

2. Detach both the round pads and rectangular pad from their safety film and stick them to the targeted part of your body according to the pad placement visual guidelines provided by PowerDot App or in this manual.

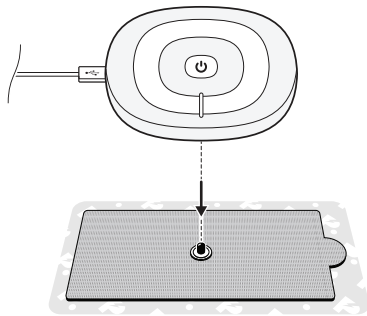

3. Attach female magnetic round pad connectors on the lead cable to the male snaps on the round pads. Attach PowerDot device female magnetic connector to the male snap on the rectangular pad.
4. Make sure the entire surface of the round and rectangular pads are completely and securely attached to your body.
5. Turn on your PowerDot(s) if you haven't already done so.



*Always thoroughly inspect the lead cable and PowerDot device for any signs of damage BEFORE every stimulation session. Do not use damaged accessories or devices. For your safety, you are strongly advised to replace them before using again.*

## 5 LAUNCHING & CONTROLLING A STIMULATION SESSION

Once you select muscle group for stimulation, assemble and place your PowerDot(s) (or PowerDots) and pads as directed. The App will automatically check for, and display, remaining battery level and lead cable connection status. After the checks, Get Started button will appear, which means you can launch the stimulation session.

Using the PowerDot Patient App, you can control your stimulation session from the Stimulation Dashboard, which has the following controls available:

**Timer Indicator 1** displays the remaining time for the total stimulation session as well as time left for the currently active stimulation phase. Stimulation program and stimulation phase names are also displayed here.

**Contraction/Rest Indicator 2** - for the programs and phases involving muscle contractions, which helps you understand the time between and during contraction and rest intervals.

**Intensity Adjustment controls** - Tap on **Intensity Increase** (or "+") 3 and **Intensity Decrease** (or "-") 4 buttons for a gradual adjustment, or hold either button down for a faster adjustment.

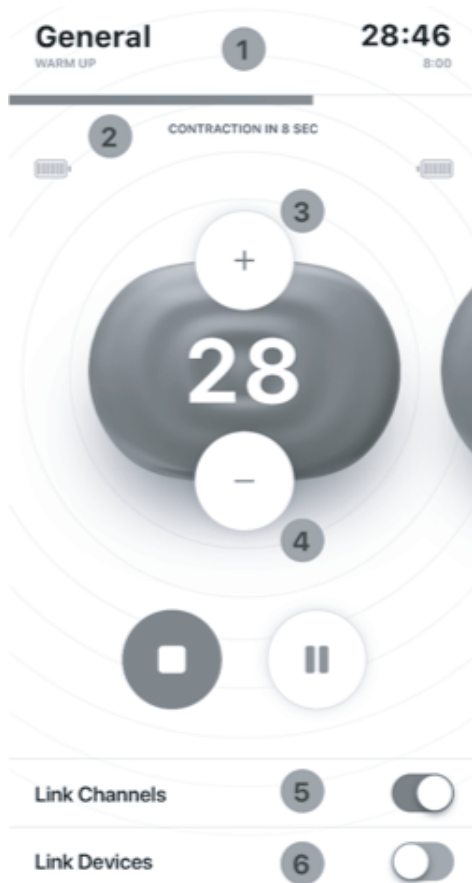

## Stimulation Channel-level Intensities

**Lock 5** and **Device-level Intensities Lock controls 6** synchronize intensity changes either **a)** between two stimulation channels of PowerDot PD-01M2 device; **b)** between PowerDot PD-01M2 devices (this setting applies to two-device Duo stimulation mode only).

Both controls are enabled by default and can be used to fine-tune the intensity of your current stimulation session. However, it's best to use them only when you really need them (e.g. ,for a better balance between your left and right sides, when your muscles are not evenly developed).

Use Stop (⏹), Pause (⏸), Resume (▶) controls to control your stimulation session.



*If you experience major discomfort or pain - PAUSE your stimulation session and/ or DECREASE intensities. For your safety, after a PAUSE, your stimulation session will resume at only 80% of your previous intensity values.*

## 6 TERMINATING STIMULATION

It's important to know the quick ways to end your stimulation when something unexpected happens (e.g., one of the pads gets detached; the stimulation area gets wet, etc.).

There are 3 primary means of immediately

terminating a session:

1. **The recommended/most commonly used option:** Tap Pause (⏸) or Stop (⏹) on the Stimulation Dashboard.
2. **OR:** press the **Multifunctional Button** on your PowerDot (or on any PowerDot when in Duo mode).
3. **OR:** quickly unplug the lead cable from PowerDot.

## 7 CARRYING & STORING POWERDOT

PowerDot PD-01M2 carry case is specifically designed for carrying and storing up to 2 PowerDot devices, their lead cables and electrode pads.

To keep electrode pads clean and make them last longer, always re-attach them to the safety film in between use, and store them in your carrying case pocket. You can use both sides of a single safety film to attach one set of PowerDot electrode pads (one side for the rectangular pad and the other for the two round pads).

## 8 DEACTIVATING POWERDOT

PowerDots can be deactivated and unpaired from a mobile phone either from within the PowerDot App or by manually resetting the PowerDot device.

For manual deactivation: when PowerDot is OFF, press and hold Multi-function button for 3 seconds until you see the power indicator

blinking.

Deactivation from the PowerDot App is performed from the My Devices screen: when your active PowerDot device is on, deactivate it by tapping on the cross icon in the top right corner.

Upon successful deactivation, the power indicator will blink several times.



*Forgot to deactivate your device from the PowerDot App? Deactivate manually by turning off your PowerDot and then holding down the Multifunction Button on the device for 3 seconds!*



*When using doctor prescribed stimulation programs, discuss the best pad placement positions as well as best positions to maintain during stimulation with your doctor and/or follow his/her advice and instructions with that regard.*

*When running a non-prescribed NMES or Pain Relief TENS sessions, ALWAYS follow pad placement guidelines from PowerDot App or this manual. The manufacturer disclaims all responsibility injuries, damages and other consequences arising from the stimulations where pad placement recommendations were not followed exactly.*

## GENERAL USAGE GUIDELINES

### ① PAD PLACEMENTS

### ② ADJUSTING STIMULATION INTENSITIES

For TENS programs or less demanding NMES programs, you are generally required to progressively increase the stimulation intensities until you see muscle twitches or feel a comfortable sensation.

For the majority of NMES stimulation programs, the efficacy of the treatment can be proportional to the maximum number of fibers being recruited; therefore, it is often required to adjust your stimulation intensity to the maximum level you can comfortably endure.

Keep in mind that maximum intensity levels

may vary, not only from one stimulation session to another, but also within the course of a single stimulation session. It's possible your muscles will adapt to stimulation at a certain intensity level reasonably quickly. Various conditions, such as differences in skin dampness or sweat, or the rate of the electrode pad deterioration, may affect the intensity of stimulation.



*When using doctor prescribed stimulation programs, follow your doctor's recommendations on the intensity levels to use.*

*For non-prescription Pain Relief TENS sessions, always follow your own feelings and sensations when you increase intensities during stimulation. Familiarize yourself with the controls and sensations at the lower and more comfortable intensities, before trying out higher intensity levels.*



*NEVER charge or recharge your PowerDot when it is attached to your body.*

*Always use the charging cable provided in your PowerDot package. (You may order new ones at [powerdot.com](http://powerdot.com)).*

*Never charge or recharge PowerDot from unreliable or problematic sources!*

*When using 3rd party party USB AC chargers, we recommend unplugging the AC plug from the wall before connecting your PowerDot device.*

## RECHARGING POWERDOT

PowerDot can be recharged from any reliable USB connection (e.g., your laptop, mobile phone charger, wall USB charger, etc.). It takes around 60 minutes for the device to go from zero charge to a full charge.

PowerDot uses built-in Lithium Polymer battery, which requires recharging after approximately 5-6 hours of continuous usage. The battery will last for at least 500 charging cycles.

If you plan to store your PowerDot unused for longer than six months, charge it to at least 50% every six months.

In the PowerDot App, the current battery charge level is displayed at the Stimulation Dashboard next to the PowerDot device silhouette.

When you see the ORANGE charging light next to micro-USB connector, it means your PowerDot is charging.

Once PowerDot is fully charged, the ORANGE light will turn off.

# PATIENT STIMULATION PROGRAMS

PowerDot App is designed to run two categories of stimulation programs:

## 1 PRESCRIBED NMES/TENS PROGRAMS

NMES/TENS programs prescribed by the doctor general have stimulation parameters tuned to specifically address your medical condition.

Once your prescription programs are scheduled by the doctor through PowerDot Doctor App or Doctor Frontend, these programs will become automatically accessible from the separate tab of PowerDot App.

Based on scheduling parameters and your notification settings, PowerDot App will be automatically offering or hiding your prescription programs, automatically updating to new parameters or settings made by your doctor, as well as notifying you about upcoming or missing sessions.

## 2 NON-PRESCRIPTION NMES PROGRAMS

### Performance Programs

Performance Programs are designed to complement your regular sports & fitness workouts, and help you improve and maintain your muscle performance.

It's ideal to run the Performance Programs 3-5 times per week during preparatory mid-season period, and 1-2 times per week during competition season or transition periods. Your daily stimulation session should usually involve stimulation of 1-3 muscle groups of your choice (and depending on the specifics and objectives of your sport) . If you use only one PowerDot device, you will need to run separate stimulation session for the left and the right sides of your muscle groups.

All Performance Programs start with a recommended 3 minutes Warm Up followed by a Main Workout phase (depending on a program, this can take anywhere from 10 to 50 minutes), which is then followed by recommended 5-minute Recovery phase.

1. **Muscle Endurance** Improves muscle endurance and fatigue resistance. Perfect for complementing your physical endurance training workouts. Recommended for slow twitch muscle groups.

For best efficiency, plan your PowerDot Muscle Endurance sessions BEFORE your usual endurance workouts.

We recommend using your PowerDot Muscle Endurance Program 4-5 times a week per muscle group during preparation period (pre-season) and 2-3 times a week during competition period (mid-season).

2. **Strength Endurance** Improves muscle ability to resist intense and prolonged effort, muscle tone and definition. Recommended for slow and some slow-fast twitch balanced muscle groups.



For best efficiency, plan your PowerDot Strength Endurance sessions BEFORE or AFTER your usual strength endurance workouts.

We recommend using your PowerDot Strength Endurance Program 3-4 times a week per muscle group during preparation period (pre-season) and 1-2 times a week during competition period (mid-season).

3. **Resistance** Improves muscle ability to resist intense and prolonged effort, increases muscle hypertrophy. Recommended for slo-fast twitch balanced and some fast muscle groups.

For best efficiency, plan your PowerDot Resistance sessions in between or after your usual workouts.

We recommend using your PowerDot Resistance Program 2-3 times a week per muscle group during preparation period (pre-season) and 1 time a week during competition period (mid-season).

4. **Strength** Improves muscle strength. Recommended for fast twitch muscle groups.

For best efficiency, plan your PowerDot Strength sessions in between or after your strength training workouts.

We recommend using your PowerDot Strength Program up to 1-3 times a week per muscle group during preparation period (pre-season) and not more than once time a week during competition

(mid-season) or de-training periods.

5. **Explosive Strength** Focuses on rapid muscle strength development. Recommended for fast and fast-fast twitch muscle groups.

For best efficiency, plan your PowerDot Explosive Strength sessions in between your physical workouts and with maximum possible rest interval.

We recommend using your PowerDot Strength Program up to 3 times a week per muscle group during preparation period (pre-season) and not more than once week during competition (mid-season) or de-training periods.

### Everyday Programs

Everyday Programs do not depend as much on meticulous planning and regularity as Performance Programs do.

While Performance Programs are intensive training programs, Everyday Programs are designed either for post-training recovery and relaxation or for pre-training preps.

1. **Active Recovery** Improves and accelerates the muscle recovery after an intense endurance exercise. Use within 2 hours of intensive workout or competition.
2. **Extended Recovery** Similar to Active Recovery, but runs longer for better effect.
3. **Light Recovery** Low frequency non-fatiguing recovery intervention. Use within 2 hours after prolonged exercise or at your convenience.

4. **Smart Recovery** Smart Recovery programs are based on the Active Recovery stimulation parameters but can customize durations of the stimulation phases as well as pulse width based on the intensity of the physical workout you have completed.
5. **Warm Up/Potentialiation** Increases contraction speed and prepares muscles for max power output. Use 5-10 minutes before important competitions events (better after regular warm-ups and stretching).
6. **Massage/Wellness Programs** Massage and Wellness Programs are designed to temporarily increase blood circulation in the area applied. Use at your convenience during your rest periods.

### 3 NON-PRESCRIPTION PAIN RELIEF (TENS) PROGRAMS

TENS Pain Relief programs can be used at any time without restrictions.

The actual stimulation programs and parameters are automatically recommended by the App based on the following selections (provided by you):

- Body part/treatment area (see Pad Placement Guidelines below)
- Type of pain: e.g., acute or chronic
- Pain Score: mild (0-3), medium (4-7), strong (8-10)
- In some cases, level of sensitivity of the treatment area

In general, PowerDot over-the-counter TENS programs can be classified into 7 categories:

1. **Conventional High Frequency** TENS (30 minutes).  
*Recommended for mild pain of acute nature*  
Pulses: continuous, bi-phasic, 32  $\mu$ S, 64  $\mu$ S or 208  $\mu$ S (depending on treatment area sensitivity), 100 Hz.
2. **Mixed** (also known as Hans) TENS (30 minutes).  
*Recommended for medium-to-strong acute pain, as well as some medium pain of chronic nature.*  
Pulses: 3 sec 80 Hz/3 sec 2 Hz duty cycle, bi-phasic, 208  $\mu$ S.
3. **1 Hz** (also known as Decontraction) TENS (30 minutes).  
*Recommended for sharp pain associated with, for example, lumbago or torticollis.*  
Pulses: continuous, bi-phasic, 240  $\mu$ S, 1 Hz.
4. **Low Frequency** (also known as Endorphinic or Acupuncture) TENS (30 minutes).  
*Recommended for mild pain of chronic nature.*  
Pulses: continuous, bi-phasic, 240  $\mu$ S, 5 Hz.
5. **Burst** TENS (30 minutes).  
*Recommended for some medium pain of chronic nature (e.g., deep muscular pain, central pain, cervical pain, sciatica pain).*  
Pulses: 2 bursts per second/5 pulses per burst, bi-phasic, 208  $\mu$ S, 80 Hz bursts.

- 6. Modulated Frequency TENS (30 minutes).**  
*Recommended for strong pain of chronic nature and certain medium-to-strong acute pain.*  
Pulses: continuous modulation, bi-phasic, 240  $\mu$ S, 3 ranges: 1-8 Hz@5 sec, 40-100 Hz@ 3 sec, 50-150 Hz@2 sec
- 7. Modulated Pulse TENS (30 minutes)**  
*Recommended for certain types of medium-to-strong acute pain (e.g., traps pain, knee pain).*  
Pulses: 2 sec continuous modulation, bi-phasic, 2 ranges: 64-208  $\mu$ S at 80 Hz, 40-160  $\mu$ S at 60 Hz

## BASIC TROUBLESHOOTING

### DEVICE DOESN'T TURN ON

PowerDot is probably low on battery. Charge your PowerDot for a few hours.

### DURING PRE-STIMULATION SET UP, POWERDOT(S) CANNOT BE FOUND (OR ARE NOT CONNECTED)

Check out PowerDot App My Devices screen and make sure that the PowerDot device you're trying to use is in the list of active devices.

Make sure your PowerDot is turned on (the white light is on in the device).

If device is charged and active but still doesn't connect. Terminate your PowerDot App through the Task Manager, restart Bluetooth (via your mobile phone's Settings menu) and try again.

### STIMULATION DOES NOT PRODUCE THE USUAL SENSATION

Check that your electrode pads are firmly attached to your body and are correctly positioned (as advised on the Pre-Stimulation screen). Put the stimulation on pause, re-attach or reposition pads, then resume stimulation.

### THE STIMULATION CAUSES DISCOMFORT OR A BURNING FEELING

If you're using standard intensity modes, then your pads may be worn out and/or the stimulation and re-attach your pads firmly, then resume stimulation. If the same or losing their bonding strength. Pause again, and replace your pads. sensation continues, pause the stimulation

### ELECTRODE PADS DON'T STICK TO THE BODY OR STIMULATION IS SURPRISINGLY VERY WEAK EVEN ON HIGHER INTENSITIES

Replace your electrode pads. Most likely, they're worn out. If that doesn't work, check your lead cable for physical damage. If there is any damage, replace the lead cable.

## **CAN'T ACTIVATE POWERDOT DEVICE OR MOBILE PHONE STOPPED CONNECTING TO THE POWERDOT**

- Remove all active PowerDots from your My Devices menu option. To remove, tap and hold on the PowerDot device image, then tap on the right top corner cross icon.
- Perform manual factory reset of your PowerDot(s) by turning the device off and then holding the button on the device for around 5 seconds until you see power light blinking several times.
- Terminate your PowerDot App using the task manager on your mobile device.
- Go your phone/tablet Bluetooth Settings and remove/forget all devices that start with PowerDot. For later Android phone models, clearing Bluetooth caches is also highly recommended (it can be done from Settings → Application Manager → All → Bluetooth).
- Restart your phone.
- Launch your PowerDot App and try to activate your device.
- If after taking all of the steps above, you still experience connectivity problems, please send your phone model, OS version, and the list of actions you performed to reactivate your PowerDot(s) to [service@powerdot.com](mailto:service@powerdot.com). We will respond within 24 hours.

## **PAD PLACEMENT GUIDELINES**

When running doctor prescribed NMES and TENS programs, please refer to PowerDot App pre-stimulation screens, which contain the most suitable visual or photo-based guidelines from your doctor.

For TENS programs, the following set ups are recommended:

CALF



WRIST

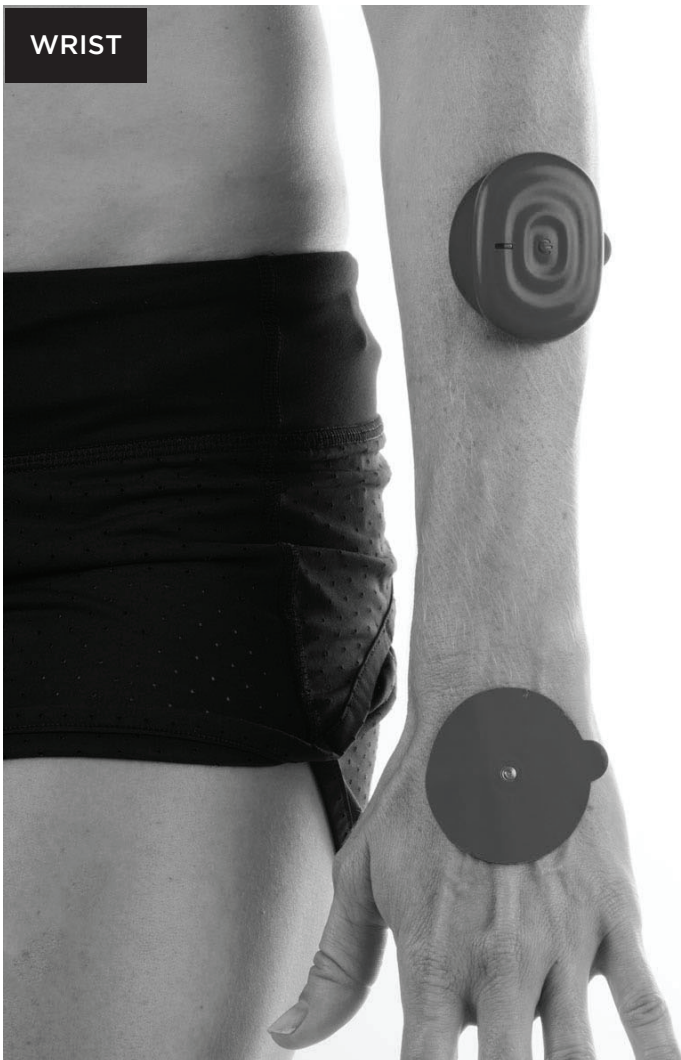

# ELBOW



FOOT





BACK

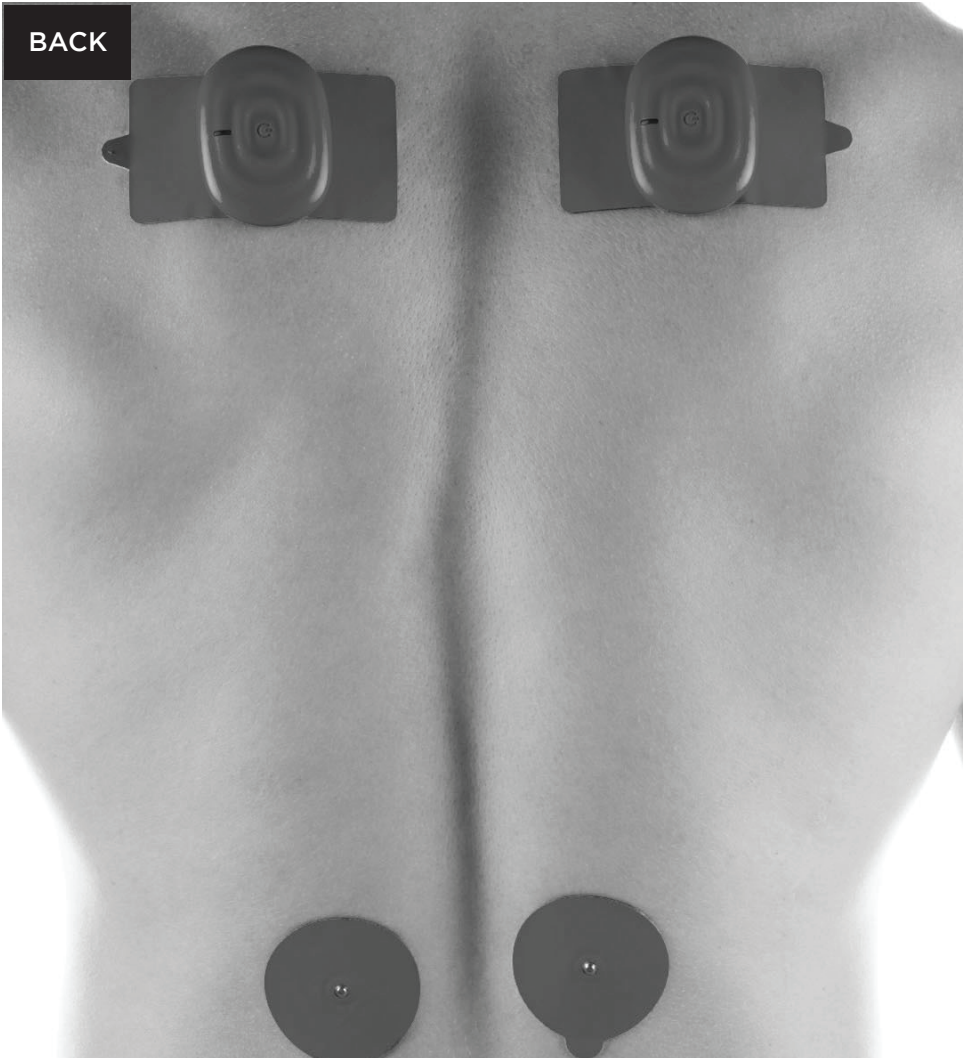

HIP



KNEE



HIP

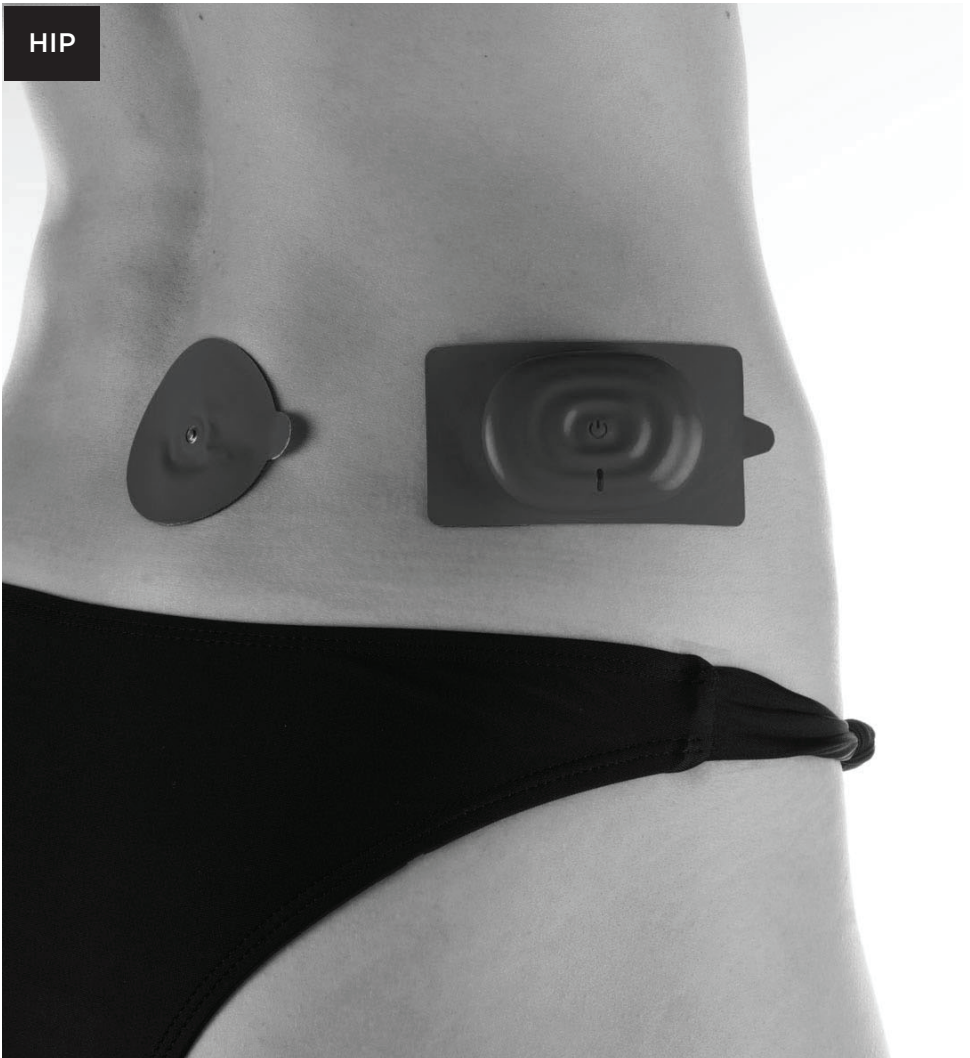

LUMBAR



QUAD



TRAPS

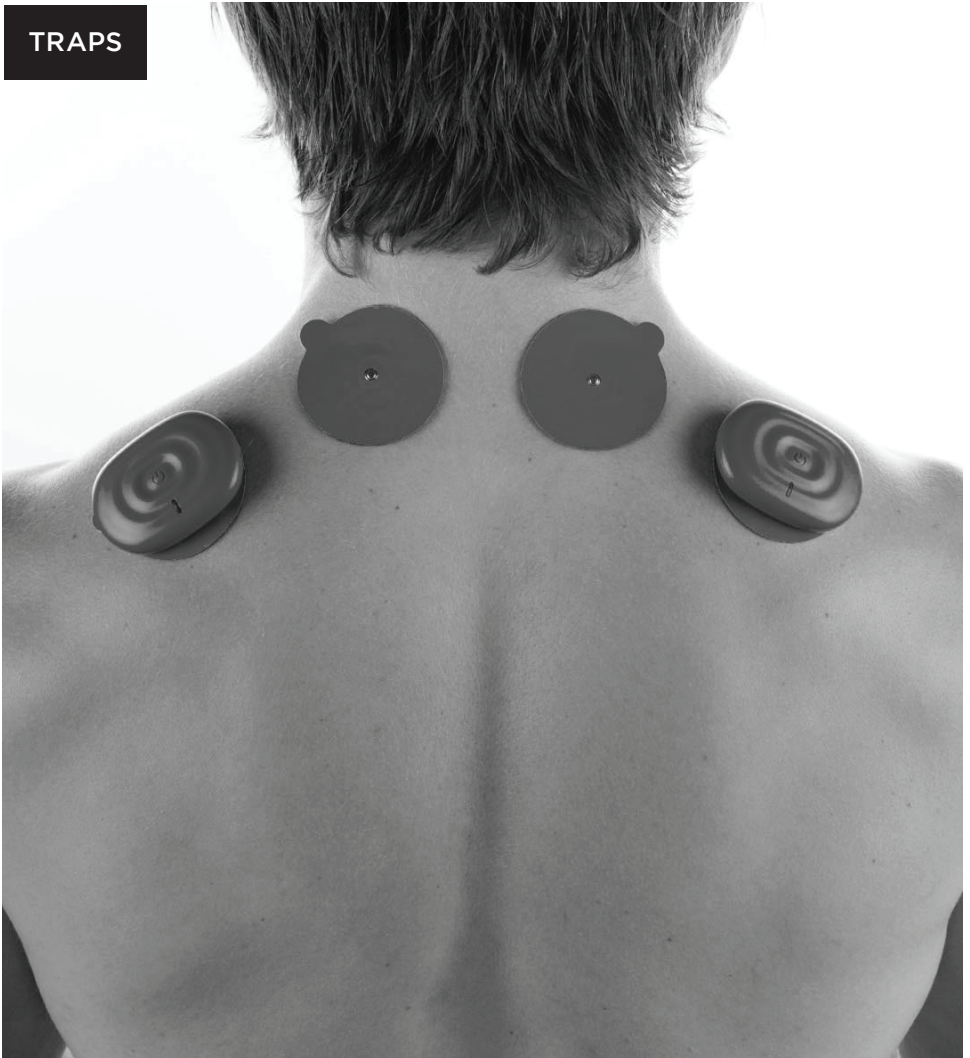

RIBS





SCIATIC NERVE



SHOULDER



**TRAPEZIUS**

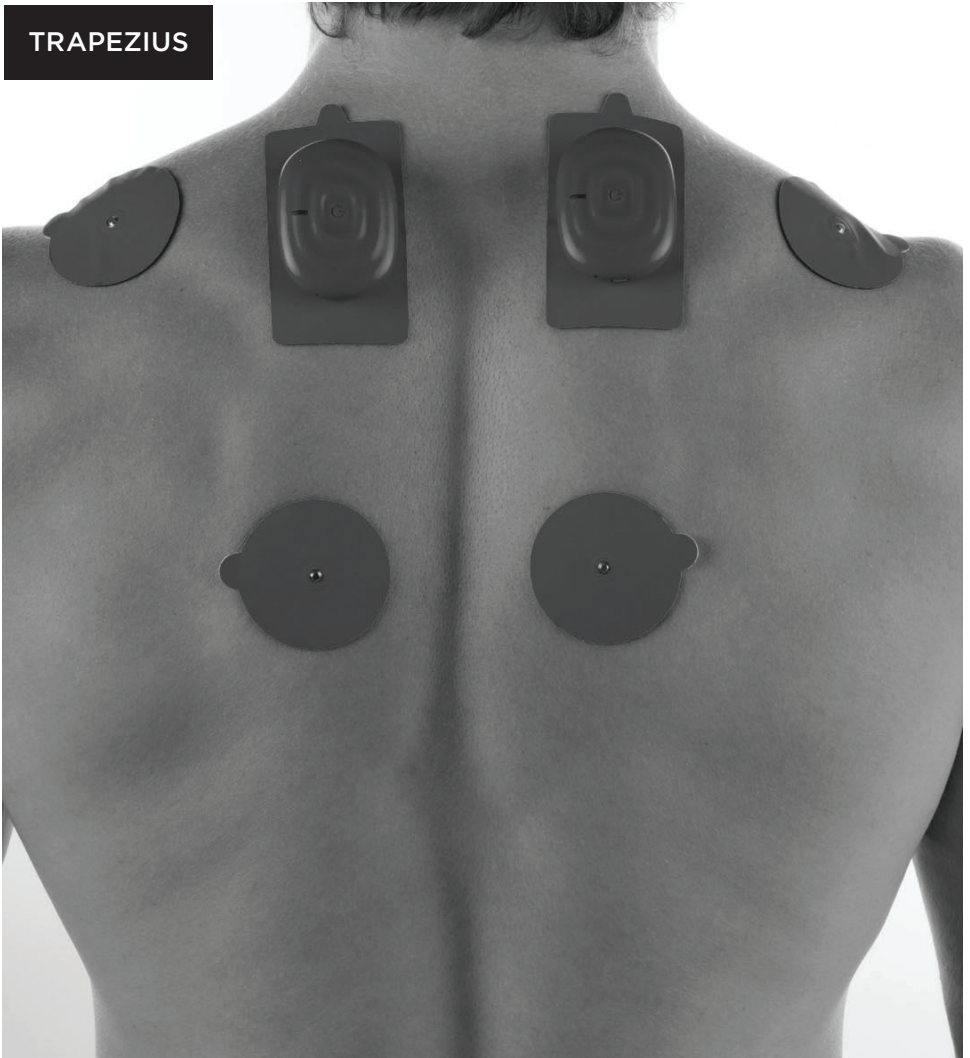

PERIOD PAINS

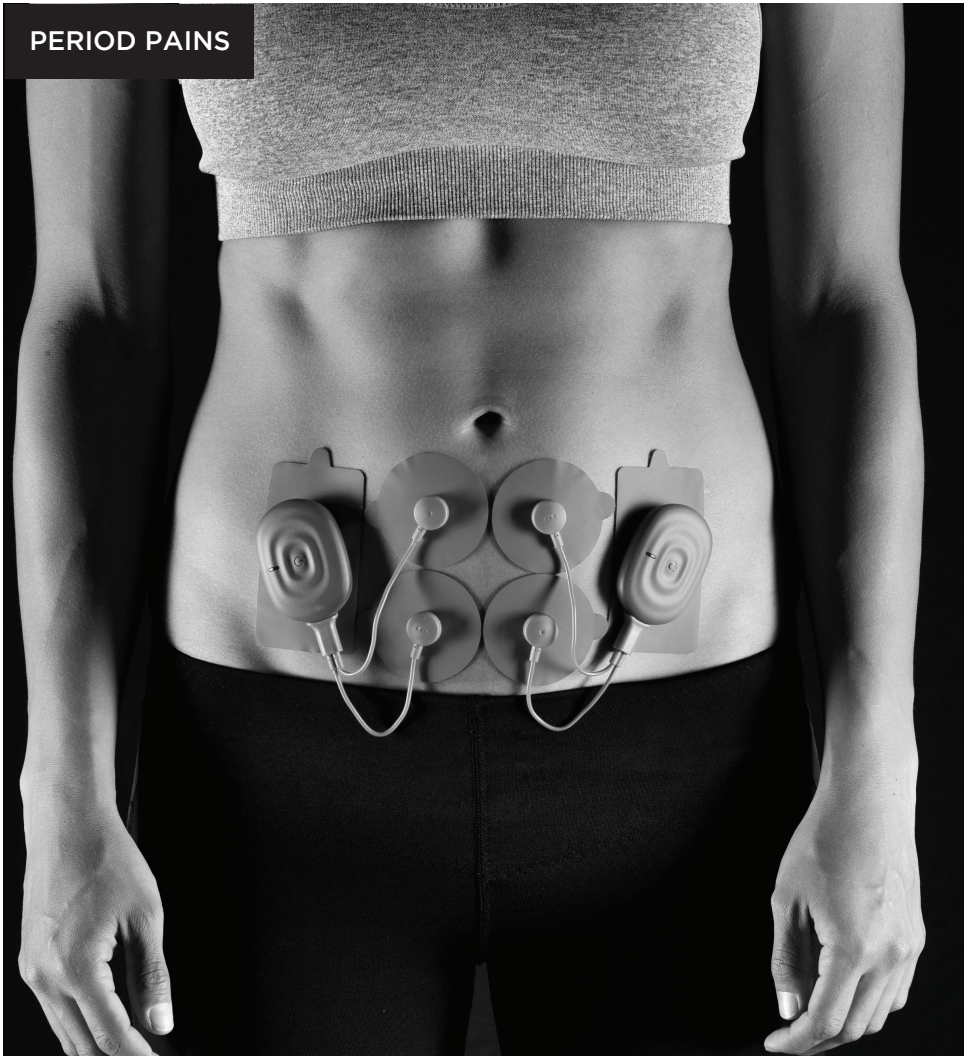

# POWERDOT MAINTENANCE

Your PowerDot pod(s) and accessories should be kept in your PowerDot carry case and carefully stored on a secure surface, under the conditions listed in the Warnings above.



*Replace your electrode pads after 20 uses as recommended. Deteriorated & worn out pads can cause major discomfort during stimulation, impacting the effectiveness of your PowerDot(s) and even lead to minor injury.*



*Cleaning: only clean PowerDot device and electrode pads using a dry soft cloth.*



*Keep PowerDot device and electrode pads away from water. Store them in a dry place, in protective packaging or in the PowerDot carry case.*

PowerDot devices do not require calibration or verification of performance parameters. The characteristics are systemically verified and validated for each device manufactured. Those characteristics are stable and do not vary when used under normal conditions. The manufacturer states that PowerDot

cannot be repaired by personnel external to the company. Any work of this nature carried out by personnel not authorized by the manufacturer will be classified as tampering with the unit, thereby releasing the manufacturer from any responsibility with regards to the warranty and hazards that the operator or user may be exposed to.

## POWERDOT WARRANTY

PowerDot is covered by a worldwide warranty of 2 years, which comes into effect on the date of purchase of the device (proof of purchase is required).

The warranty does not apply to the electrode pads and carry cases. Within the warranty period, manufacturer will replace your faulty PowerDot or accessories at no charge (except shipping & handling fees in some cases), provided that the product:

- Has been used for the intended purpose and in the manner described in this manual
- Has not been connected to an unsuitable power source
- Has not been subjected to misuse or neglect
- Has not been modified or repaired
- Has not been damaged further by shock
- Legal rights are not affected by this warranty.

# TECHNICAL SPECIFICATIONS

*All electrical specifications are given for an impedance of 1000  $\Omega$  per channel.*

**Battery:** Lithium Polymer (LiPo) rechargeable 3.7 V, 210 mAh (-5-6 hours of continuous stimulation on average parameters).

**Charging Input:** 5V through USB 2.0 or 3.0 connections (custom micro-USB to USB charging cable is provided as part of the package), I/P rating: 5Vdc = 1-2.1A

**Stimulation Channels:** 2 independent, optically isolated

**Stimulation Waveform:** Bi-phasic rectangular with zero mean (under load)

**Supported Stimulation Frequency Range:** 1-150 Hz

**Supported Stimulation Pulse Width:** 32-416  $\mu$ s (for main/positive phase)

**Maximum output voltage/amperage:** 125 V/125 mA (+-5%)

**Bluetooth:** Built-in Bluetooth Low Energy 5.0

**Electro-compatibility (EMC):** ETSI EN 301 489-1/EN 301 489-17/EN 50385/EN 55011/IEC 60601-1-2

## C RF Data:

- Operating Frequency Range: 2402 MHz-2480 MHz (ISM range)
- Modulation Type: GFSK
- Peak Transmit Power: EIRP: 2dBm (1.58mW)
- Channel Spacing/Number of Channels: 2MHz, 40 channels (3 for advertising, 37 for data)
- Antenna Type: PCB Antenna, 1.5 dBi gain

## Mobile Application Compatibility:

- Android 6.0 Marshmallow (or later) powered smart phone with Bluetooth Smart Ready compatibility and High Definition (or better) touch screen
- Apple iPhone 4S/iPod 5th Gen or newer smart phone powered by iOS 8.0 (or later)

**Device Dimensions:** 60.4x43.5x13.6 mm

**Device Weight:** 25 g

## Environment Specifications:

- **Operating/Storage/Transport:** Temperature from 0°C to +40°C  
The maximum temperature of the applied part could be 42.3°C while using in the 40°C environment.
- **Humidity:** 10-90% RH
- **Atmospheric pressure:** from 700 hPa to 1060 hPa

**Product Expected Lifetime:** 5 years

**Housing:** ABS & TPU

**Limitations:** product is not suitable for use in the environments with a high concentration of oxygen and/or flammable liquids and/or flammable gas; do not use with equipment for electro surgery or short-wave or microwave therapy; the device may be interfered by other equipment, even if that other equipment complies with CISPR EMISSION requirements.

PowerDot PD-01M2 has been tested to the compliance with the following Emission and Immunity standards:

## EMMISSION:

STANDARD	ITEM	REMARKS
CISPR 11: 2011	Conducted	Class B
	Radiated	Class B
IEC 61000-3-2:2014	Harmonic current emissions	
IEC 61000-3-3:2013	Voltage fluctuations & flicker	

## IMMUNITY:

STANDARD	ITEM	IEC 60601-1-2 Test Levels for Home Healthcare Environment	PowerDot PD-01 M2 Test Levels	REMARKS
IEC 61000-4-2:2008	ESD	8 kV contact; 2 kV, 4 kV, 8 kV, 15 kV air	2 kV, 4 kV, 8 kV contact; 2 kV, 4 kV, 8 kV, 15 kV air	No performance degradation observed.
IEC 61000-4-3:2010	RS	10 V/m 80 MHz - 2.7 GHz 80% AM at 1 kHz	10 V/m 80 MHz - 5.785 GHz 80% AM at 1 kHz	No performance degradation observed.
IEC 61000-4-4:2012	EFT	2 kV 100 kHz repetition frequency	2 kV 100 kHz repetition frequency	No performance degradation observed.
IEC 61000-4-5:2014	Surge	0.5 kV, 1 kV	0.5 kV, 1 kV	No performance degradation observed.

IEC 61000-4-6:2013	CS	3V 0.15 MHz – 80 MHz  6V in ISM and amateur bands between 0.15 MHz and 80 MHz  80% AM at 1 kHz	10V 0.15 MHz – 80 MHz  80% AM at 1 kHz	No performance degradation observed.
IEC 61000-4-8:2009	PFMF	30 A/m 50 Hz or 60 Hz	30 A/m 50 Hz	No performance degradation observed.
IEC 61000-4-11:2004	Voltage dips & voltage variations	<b>Voltage Dips:</b> 1) 0% UT; 0,5 cycle at 0°, 45°, 90°, 135°, 225°, 270°, 315°  2) 0% UT; 1 cycle; Single phase at 0°  3) 70% UT; 25/30 cycles; Single phase at 0°  <b>Voltage Interruptions:</b> 0% UT; 250/300 cycle;	As on the previous column	<b>Voltage Dips:</b> 1) No performance degradation observed  2) No performance degradation observed  3) No performance degradation observed  <b>Voltage Interruptions:</b> Performance degradation (device stopped charging) has been observed only during voltage interruption testing, but no degradation observed after the testing



# BLUETOOTH CONNECTIVITY

PowerDot stimulators are controlled through Bluetooth Low Energy wireless radio interface.

PowerDot is specifically designed to be used together with PowerDot App, which is supported for the selected Android and iOS mobile devices.

## SECURE PAIRING

Your PowerDot is paired with your mobile phone using secure 8 digit numeric code which, by design, prohibits any other mobile phones or wireless devices to connect to your PowerDot. Secure pairing takes place during PowerDot activation process (see Activating PowerDot above) and, once your PowerDot becomes active, numeric activation code is written into PowerDot's flash memory and gets verified by your PowerDot App after every PowerDot restart.

All Bluetooth commands sent from your mobile phone to PowerDot device are securely encrypted using Bluetooth AES-128 encryption protocol.

## DISCONNECTIONS AND QUALITY OF SERVICE

PowerDot Mobile App and PowerDot PD-01M2 Bluetooth communication interface are specifically designed to accommodate temporarily and permanent Bluetooth

disconnections during a stimulation session. PowerDot PD-01M2 device is capable of independent execution of a pre-loaded stimulation program with the latest intensity values as well as implements automatic Bluetooth re-connections.

In this regard, temporary radio frequency interference (e.g. caused by co-existence of multiple Bluetooth and/or Wi-Fi devices in your range) should not affect the overall efficiency and safety of your stimulation session.

Due to hardware-level emergency stop mechanisms (see Directions For Use), Bluetooth disconnections of more permanent nature should not affect the safety of stimulation, and can only cause temporary inconvenience by forcing you to postpone your planned stimulation session until a more favorable Bluetooth connectivity environment is established.

Like any wireless device, PowerDot PD-01M2 emits very low levels in the radio frequency (RF) interval, and, is therefore not likely to cause any interference with nearby electronic equipment (e.g. radios, computers, telephones, etc.).

PowerDot PD-01M2 is designed to withstand foreseeable disturbances originating from electrostatic discharges, mains supply magnetic fields, or radio frequency transmitters.

Despite this, it is not possible to guarantee that the stimulator will not be affected by strong RF (radio frequency) fields emitting from other sources (such as in the proximity

of working microwave oven).

	<p><i>Try not to use PowerDot closer than 1.5 meters to a working microwave oven as radio interference from a microwave is likely to cause disconnection between PowerDot and your mobile phone.</i></p>
--	--





## TROUBLESHOOTING WIRELESS CONNECTIVITY

If you run into issues with Bluetooth wireless connectivity (e.g., your PowerDot PD-01M2 device becomes unresponsive to PowerDot App commands during stimulation session or you were not able to connect to your PowerDot and initiate stimulation), try terminating your stimulation session manually by shortly pressing Power button on your PowerDot device.

PowerDot App has built-in re-connection and disconnection detection mechanisms and, in most cases, it will re-connect to your PowerDot shortly and allow you to resume your session using the Resume button on the screen.

If you fail to re-connect and resume your session after several attempts, consider stopping your stimulation session using Stop button on the Stimulation Screen and postponing it for later.

## USED SYMBOLS

	Serial Number
	Stand by
	Attention
	Direct Current (DC)

The device complies with Part 15 of FCC. Operation is subject to the following conditions:

- A. This device may not cause harmful interference, and
- B. This device must accept any interference received, including interference that may cause undesired operation.

Changes or modifications not expressly approved by the party responsible for compliance could void the user's authority to operate the equipment.





This equipment has been tested and found to comply with the limits for a Class B digital device, pursuant to Part 15 of the FCC Rules. These limits are designed to provide reasonable protection against harmful interference in a residential installation.





This equipment generates, uses and can radiate radio frequency energy and, if not installed and used in accordance with the instructions, may cause harmful interference to radio communications. However, there is no guarantee that interference will not occur in a particular installation.

If this equipment does cause harmful interference to radio or television reception, which can be determined by turning the equipment off and on, the user is encouraged to try to correct the interference by one or more of the following measures:

- Reorient or relocate the receiving antenna.
- Increase the separation between the equipment and receiver.
- Connect the equipment into an outlet on a circuit different from that to which the receiver is connected.
- Consult the dealer or an experienced radio/TV technician for help.

## EU ONLY SYMBOLS:

	<p>The symbol on your PowerDot unit is to indicate conformity with the requirements of the MDD (Medical Device Directive 93/42/EEC) &amp; MDR (Medical Device Regulation 2017/745)</p>
	<p>Manufacturer</p>
	<p>EU Authorized representative</p>
	<p>Internally powered device Class II with Type BF applied parts</p>

	<p>Product subject to WEEE regulations concerning separate waste collection</p>
 <p>Read the instructions for use carefully before using this device</p>	
<p>IP 22</p>	<p>IP22 IP Rating IP22</p>
	<p>An indication that the device is a medical device</p>
	<p>Unique Device Identification for medical device</p>
	<p>Pads intended for single-user only for hygiene purposes</p>

## MANUFACTURER & AFTER-SALE SERVICE

Smartmissmo Technologies Pte Ltd  
 4 Shenton Way, #15-01 SGX Centre II  
 Singapore 068807

E-Mail: [service@powerdot.com](mailto:service@powerdot.com)

Phone: +1-844-479-7368

*Contact for any assistance in setting up, using, maintaining, or reporting unexpected operation or events.*

## EU AUTHORISED REPRESENTATIVE:

Medical Technology Promedt Consulting GmbH,  
 Altenhostrasse 80, 66386, St. Ingbert, Germany

# ELECTROMAGNETIC COMPATIBILITY (EMC)

PowerDot PD-01M2 is designed to be used in home healthcare environments in accordance with the EMC safety standard IEC 60601-1-2 (4th Edition) and with limitations, defined by the warnings and precautions in this manual (e.g. operation near RFID emitters, working microwave ovens, etc.).

Examples of home healthcare environment include restaurants, cafes, shops, stores, markets, schools, churches, libraries, outdoors (streets, sidewalks, parks), domiciles (residences, homes, nursing homes), vehicles (cars, buses, trains, boats, planes, helicopters), train stations, bus stations, airports, hotels, hostels, pensions, museums, theatres.

PowerDot PD-01M2 is designed to support anticipated disturbance originating from electrostatic discharge, magnetic fields for the power supply or radiofrequency emitters.

However, the performance of PowerDot PD-01M2 device can still be affected by radio frequency fields originating from other sources.

For more information about EMC emissions and immunity, contact the manufacturer.



*The device should not be used adjacent to or stacked with other equipment. If adjacent or stacked use is necessary, the device should be observed to verify normal operation in the configuration in which it will be used.*



*The use of accessories, transducers and cables others than those specified or provided by the manufacturer of this equipment could result in increased electromagnetic emissions or decreased electromagnetic immunity of this equipment and result in improper operation.*



*Portable RF communications equipment (including peripherals such as antenna cables and external antennas) should be used no closer than 30 cm (12 inches) to any part of the PowerDot PD-01M2, including cables specified by the manufacturer. Otherwise, degradation of the performance of this equipment could result.*



*PowerDot PD-01M2 battery charging performance might degrade in the environments with frequent voltage interruptions (when charging from the wall adapter). To support consistent and reliable charging, the usage of uninterrupted power supply (UPS) is highly recommended, if operating in such environments.*

The following device function is considered essential to the safety of the user: ability to maintain consistent stimulation intensity (amplitude), pulse frequency and pulse waveform (both shape and width).

In case if the essential performance is lost or degraded due to electromagnetic disturbances, stimulation safety and effectiveness can be compromised. Whenever the patient realizes unexpected change in any of stimulation parameters, it's advised to terminate the stimulation

session immediately by using one of the methods provided in the Terminating Stimulation section.

# CONTENTS

POWERDOT M2	3
INDICATIONS FOR USE	3
WARNINGS AND SAFETY GUIDELINES	5
DIRECTIONS FOR USE	10
GENERAL USAGE GUIDELINES	14
CHARGING POWERDOT	15
PATIENT STIMULATION PROGRAMS	16
BASIC TROUBLESHOOTING	19
PAD PLACEMENT GUIDELINES	20
POWERDOT MAINTENANCE	37
POWERDOT WARRANTY	37
TECHNICAL SPECIFICATIONS	38
BLUETOOTH CONNECTIVITY	41
MANUFACTURER & AFTER-SALE SERVICE	43
ELECTROMAGNETIC COMPATIBILITY (EMC)	44



# PowerDot

by Therabody

Born in Los Angeles, CA.  
Designed for every**body**.



@Therabody