

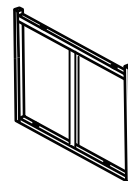







**INSTRUCTION MANUAL/BEDIENUNSANLEITUNG/NOTICE D'UTILISATION/
MANUAL DE INSTRUCCIONES DE USO/MANUALE DI ISTRUZIONI**

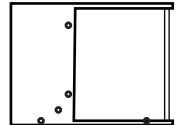
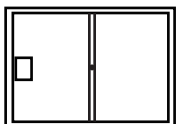
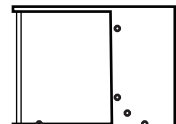
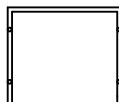
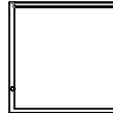





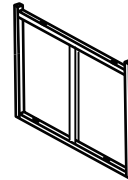

- ! WARNING!**
Adults assembly required. During assembly, keep all parts away from children. Check regularly to ensure all fasteners are tight.
- ! WARNUNG!**
Die Montage ist von Erwachsenen durchzuführen. Halten Sie während der Montage alle Teile von Kindern fern. Überprüfen Sie regelmäßig den festen Sitz der Schrauben.
- ! Attention !**
Montage à effectuer par des adultes. Pendant le montage, tenez les éléments éloignés des enfants. Vérifiez régulièrement que toutes les vis soient serrées.
- ! Atención!**
Requiere que el montaje sea llevado a cabo por un adulto. Durante el montaje, mantenga todas las piezas fuera del alcance de los niños. Verifique regularmente que todos los tornillos estén correctamente apretados.
- ! avvertimento!**
L'assemblaggio deve essere effettuato da adulti. Durante il montaggio mantenere tutti i pezzi lontano dalla portata dei bambini. Controllare regolarmente per assicurarsi che tutte le chiusure siano ben strette.

PARTS LIST/STÜCKLISTE/PARTS LIST/LISTA DE PIEZAS/LISTA DEI PEZZI

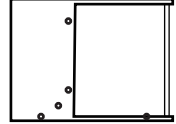
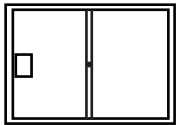
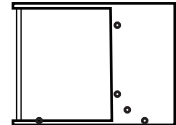
Carton A Karton A Carton A Caja A Contenitore A

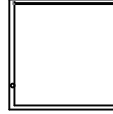
<p>H</p>  <p style="text-align: right;">1pc</p>	<p>I</p>  <p style="text-align: right;">2pcs</p>	<p>J</p>  <p style="text-align: right;">1pc</p>	<p>K</p>  <p style="text-align: right;">400x400x50mm 1pc</p>	<p>L</p>  <p style="text-align: right;">3pcs</p>
<p>M</p>  <p style="text-align: right;">3pcs</p>	<p>N</p>  <p style="text-align: right;">3pcs</p>	<p>O</p>  <p style="text-align: right;">3pcs</p>	<p>P</p>  <p style="text-align: right;">3pcs</p>	<p>Q</p>  <p style="text-align: right;">475x430x50mm 3pcs</p>
<p>R</p>  <p style="text-align: right;">475x475x50mm 3pcs</p>	<p>R1</p>  <p style="text-align: right;">475x475x50mm 3pcs</p>	<p>k1</p>  <p style="text-align: right;">400x400x50mm 1pc</p>	<p>Q1</p>  <p style="text-align: right;">475x430x50mm 3pcs</p>	

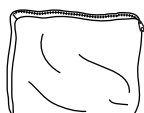
Carton B Karton B Carton B Caja B Contenitore B

<p>H</p>  <p style="text-align: right;">1pc</p>	<p>I</p>  <p style="text-align: right;">2pcs</p>	<p>J</p>  <p style="text-align: right;">1pc</p>	<p>K</p>  <p style="text-align: right;">400x400x50mm 1pc</p>	<p>L</p>  <p style="text-align: right;">3pcs</p>
<p>M</p>  <p style="text-align: right;">3pcs</p>	<p>N</p>  <p style="text-align: right;">3pcs</p>	<p>O</p>  <p style="text-align: right;">3pcs</p>	<p>P</p>  <p style="text-align: right;">3pcs</p>	<p>Q</p>  <p style="text-align: right;">475x430x50mm 3pcs</p>
<p>R</p>  <p style="text-align: right;">475x475x50mm 3pcs</p>	<p>R1</p>  <p style="text-align: right;">475x475x50mm 3pcs</p>	<p>K1</p>  <p style="text-align: right;">400x400x50mm 1pc</p>	<p>Q1</p>  <p style="text-align: right;">475x430x50mm 3pcs</p>	

**RETAIN FOR FUTURE REFERENCE
FÜR KÜNFTIGE VERWENDUNG AUFBEWAHREN
A CONSERVER POUR UNE UTILISATION FUTURE
CONSERVAR PARA SER LEÍDO POR CADA NUEVO USUARIO
ANTES DE UTILIZAR EL ARTÍCULO POR PRIMERA VEZ
CONSERVARE PER CONSULTAZIONI FUTURE**

Carton C Karton C Carton C Caja C Contenitore C

A 2pcs	B 1pc	C 2pcs	D 2pcs	E 1pc					
H 2pcs	I 4pcs	J 2pcs	K 400x400x50mm 2pcs	k1 400x400x50mm 2pcs	S1 M6x50 8pcs	S2 M6x40 12pcs			
S3 M6x35 54pcs	S4 M6x30 16pcs	S5 M6x15 28pcs	T 16pcs	U M6 126pcs	V M6 8pcs	W 1pc	X 1pc	Y 1pc	Z 18pcs

Carton D Karton D Carton D Caja D Contenitore D

F 1032x514x5mm 1pc	G 1032x502x5mm 2pcs
------------------------------	-------------------------------

ASSEMBLY/MONTAGE/ASSEMBLAGE/MONTAJE/ASSEMBLAGGIO



Warning! Tight all the screws to 60% first then tight to 100%.
Warnung! Während der Montage alle Schrauben zuerst 60% anziehen, dann zu 100%.
Attention! Serrez toutes les vis à 60% d'abord puis serrez à 100%.
Atención! Primero apriete los tornillos al 60% y después al 100%.
Avvertimento! Stringere le viti dapprima al 60% e successivamente completamente al 100%.

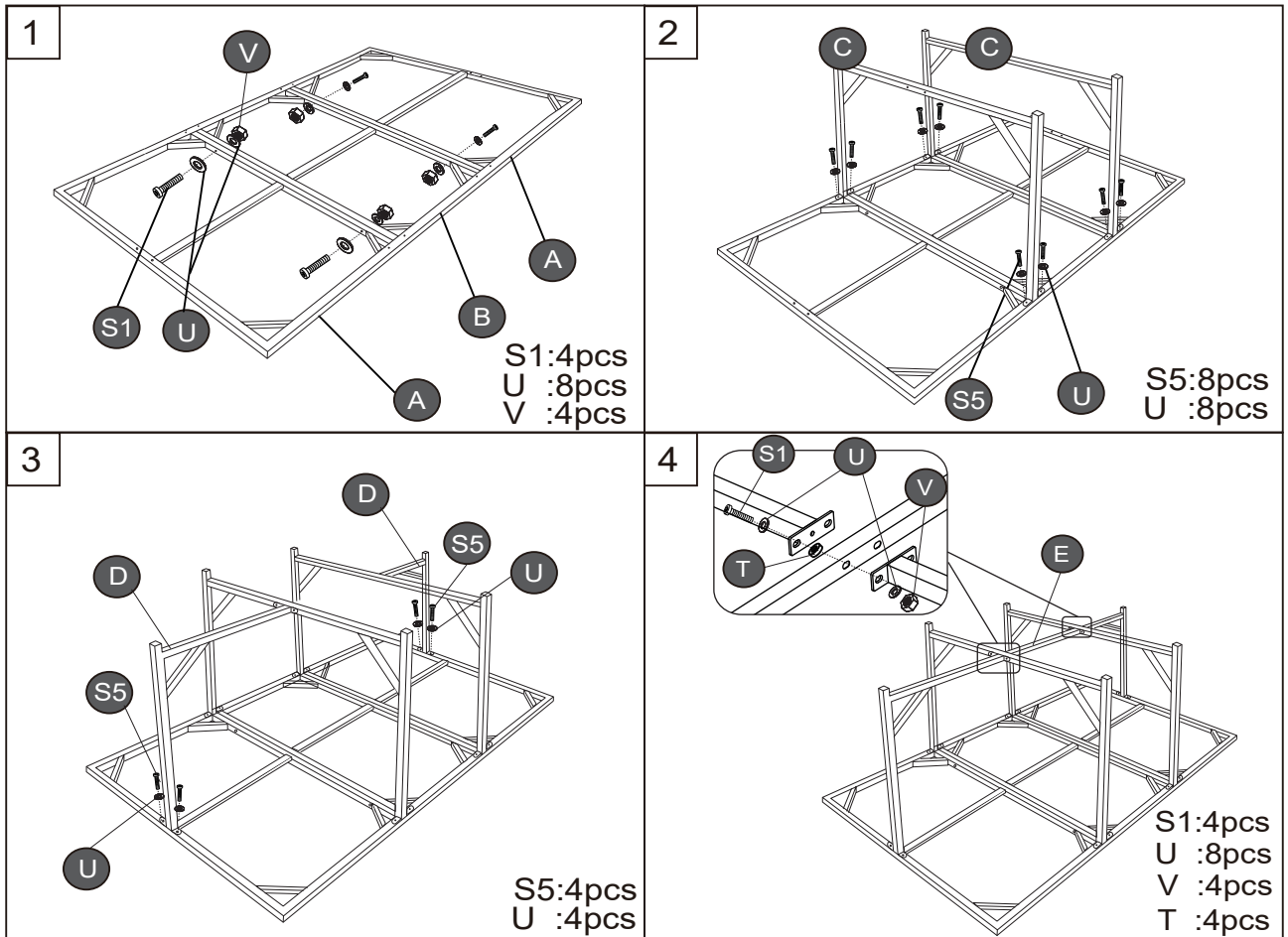



Warning!
Warnung!
Attention !
Atención!
Avvertimento!

Tight all the screws to 60% first then tight to 100%.
 Während der Montage alle Schrauben zuerst 60% anziehen, dann zu 100%.
 Serrez toutes les vis à 60% d'abord puis serrez à 100%.
 Primero apriete los tornillos al 60% y después al 100%.
 Stringere le viti dapprima al 60% e successivamente completamente al 100%.

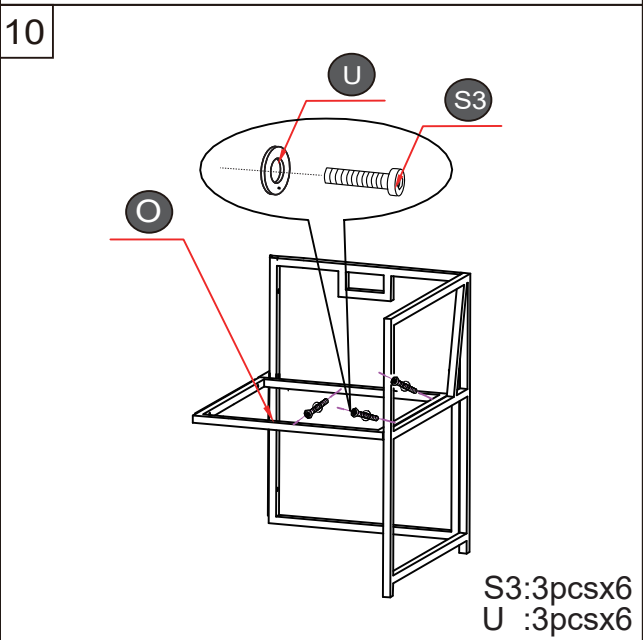
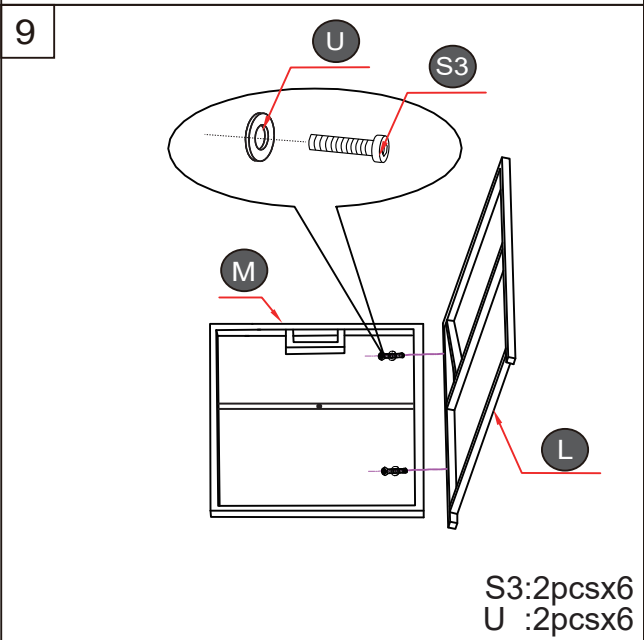
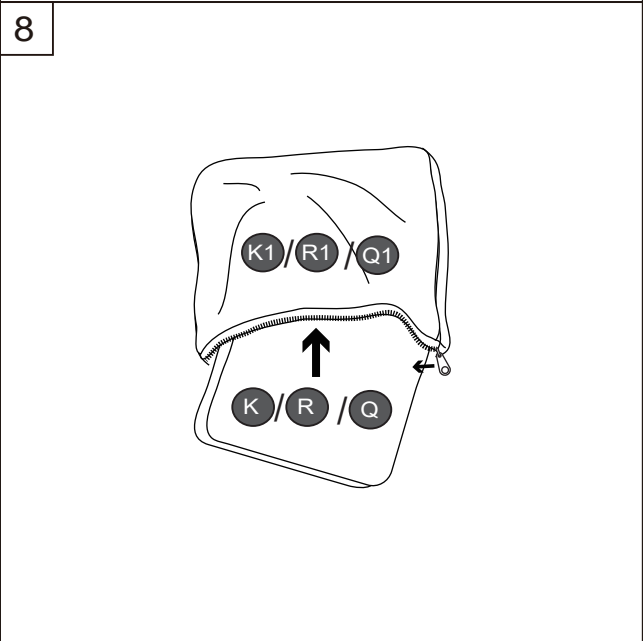
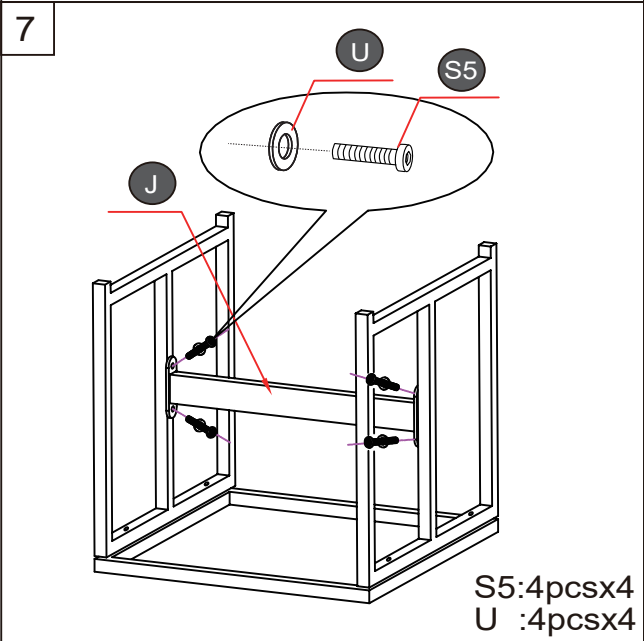
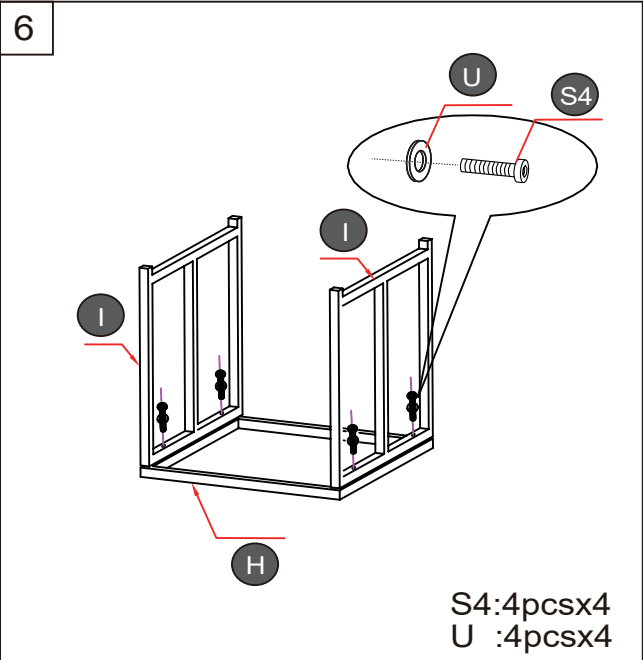
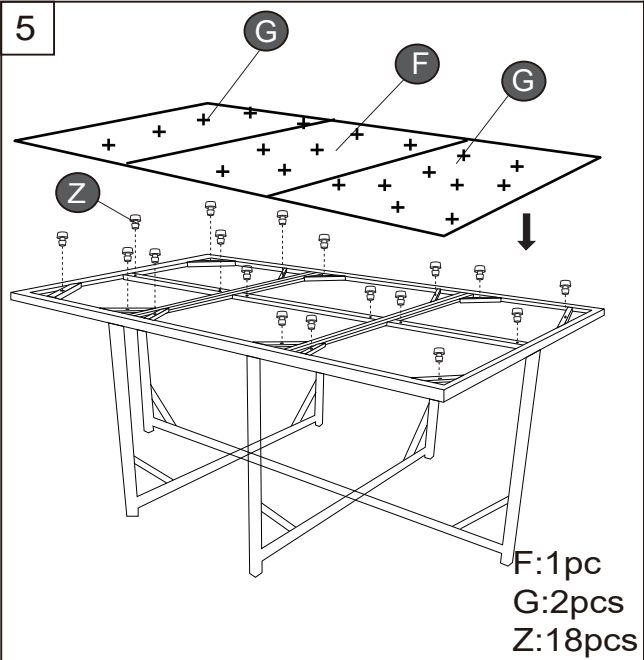



Warning!
Warnung!
Attention !
Atención!
Avvertimento!

Tight all the screws to 60% first then tight to 100%.
Während der Montage alle Schrauben zuerst 60% anziehen, dann zu 100%.
Serrez toutes les vis à 60% d'abord puis serrez à 100%.
Primero apriete los tornillos al 60% y después al 100%.
Stringere le viti dapprima al 60% e successivamente completamente al 100%.

