

Art. No.67545-110

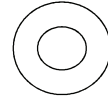
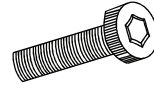
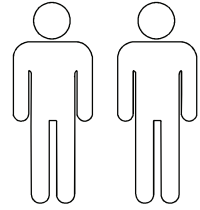
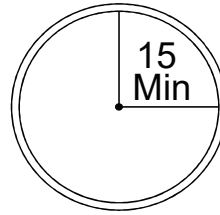

(8x20mm)

(8 Pcs.)

(8 Pcs.)

(1 Pcs.)

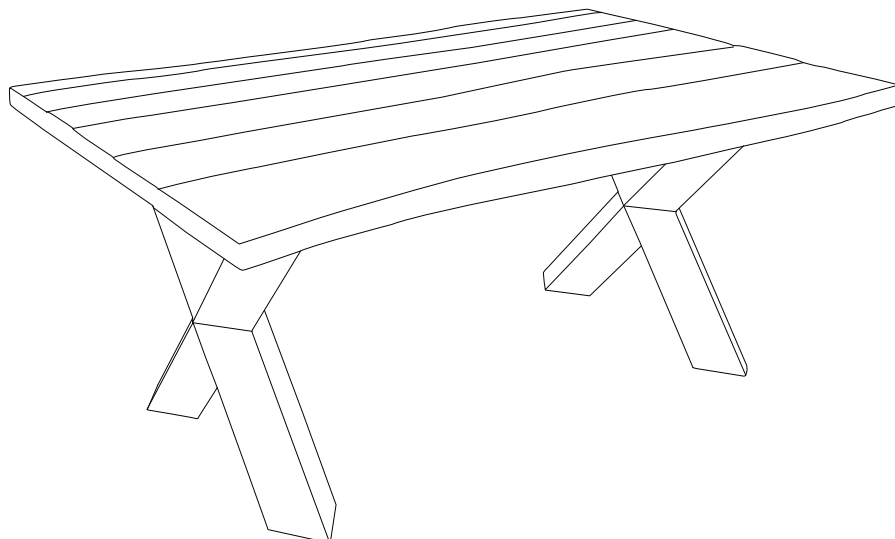
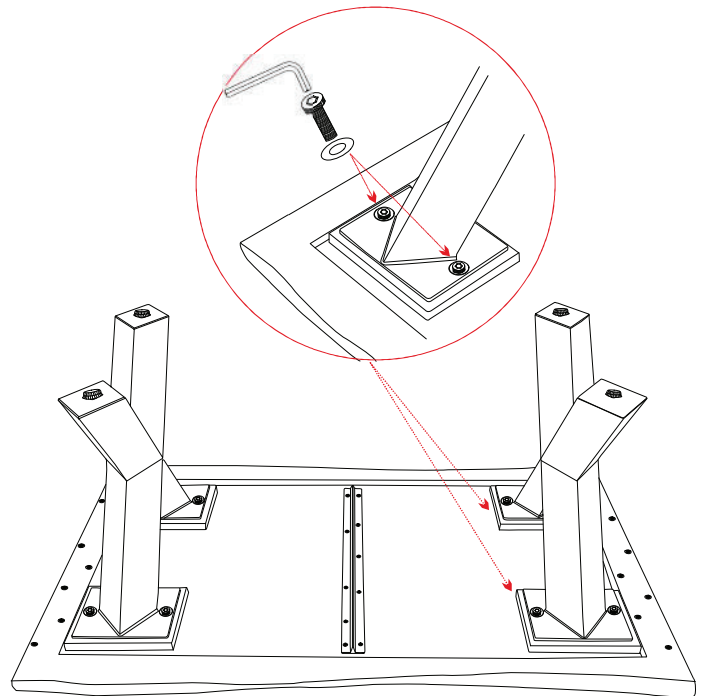
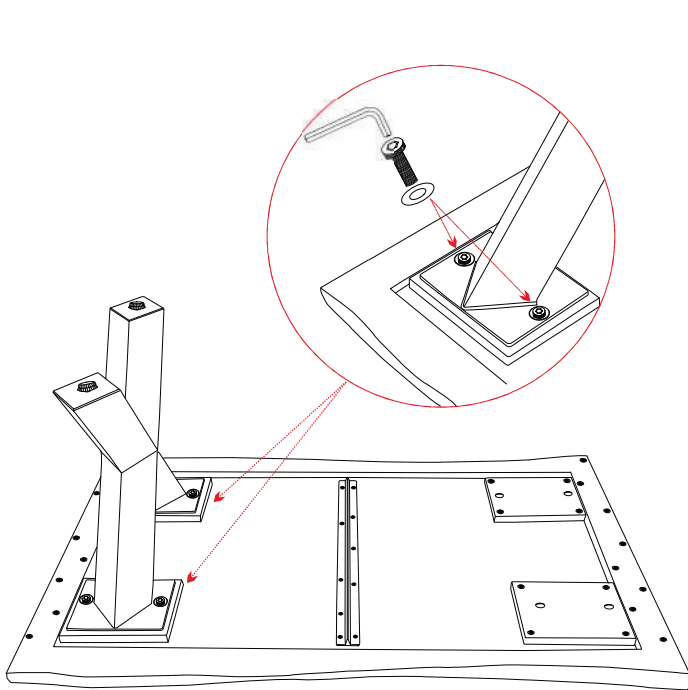

Assembled Product