

HUSUM
8300/3300-0037
3100-0037/8300

F/B

171003

- | | | | |
|-----------|--|-----------|---|
| D | MONTAGEANLEITUNG
BEDIENUNGSANLEITUNG | GB | ASSEMBLY INSTRUCTIONS
INSTRUCTION MANUAL |
| NL | HANDLEIDING VOOR DE MONTAGE
GEBRUIKSAANWIJZING | PL | INSTRUKCJA MONTAŻU
INSTRUKCJA OBSŁUGI |
| TR | MONTAJ TALIMATI
KULLANIM KLAVUZU | RU | ИНСТРУКЦИЯ ПО МОНТАЖУ
ИНСТРУКЦИЯ ПО ЭКСПЛУАТАЦИИ |
| RO | INSTRUCȚIUNI DE INSTALARE
INSTRUCȚIUNI DE UTILIZARE | IT | ISTRUZIONI DI MONTAGGIO
MANUALE DI ISTRUZIONI |
| FR | NOTICE DE MONTAGE
MANUEL INSTRUCTIONS | SK | MONTÁŽNY NÁVOD
NÁVOD NA POUŽITIE |
| HU | KÖZGYŰLÉS UTASÍTÁSOK
KEZELÉSI UTASÍTÁS | CZ | MONTÁŽNÍ NÁVOD
NÁVOD K POUŽITÍ |
| SI | NAVODILA ZA MONTAŽO
NAVODILA ZA UPORABO | PT | INSTRUÇÕES DE MONTAGEM
MANUAL DO USUÁRIO |
| ES | INSTRUCCIONES DE MONTAJE
MANUAL DEL USUARIO | HR | UPUTE ZA MONTAŽU
UPUTE ZA UPOTREBU |

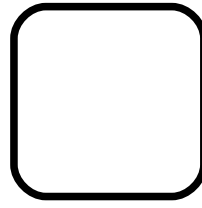
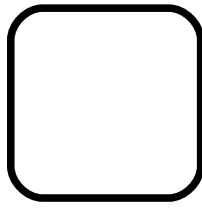

0019

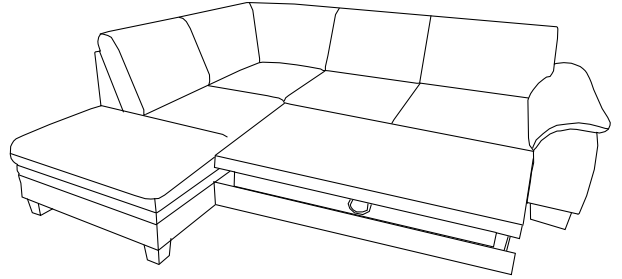
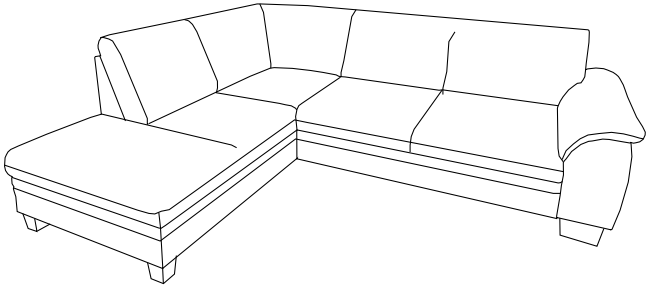

0019

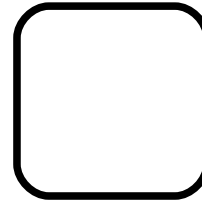
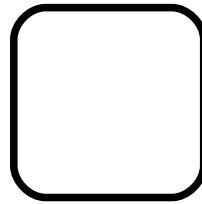

0088

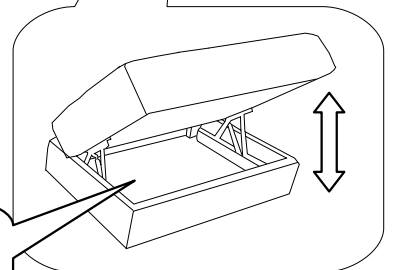
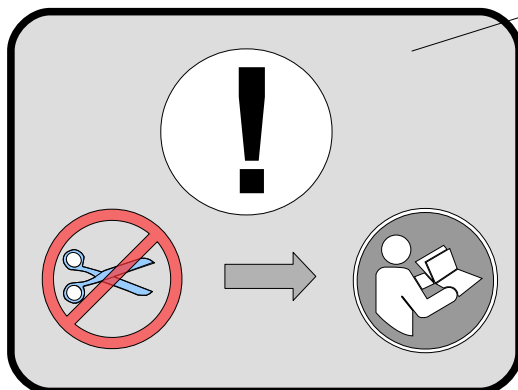
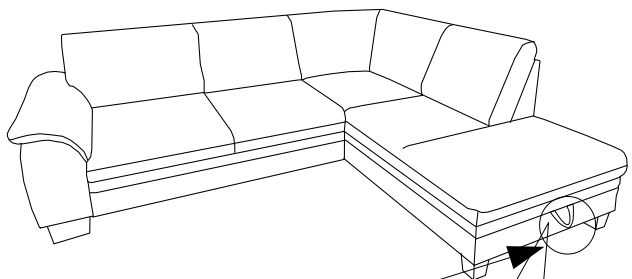
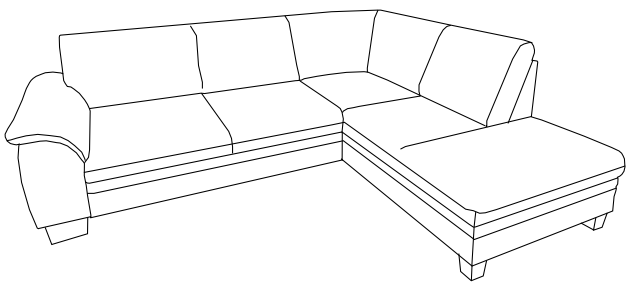

0037

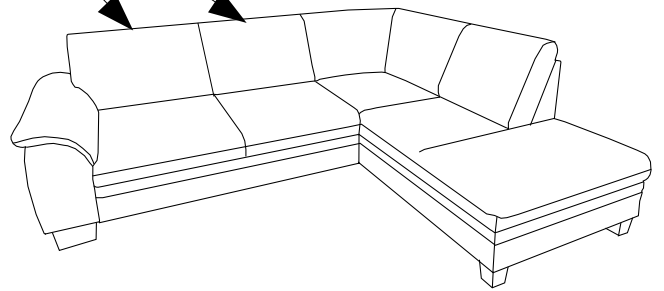
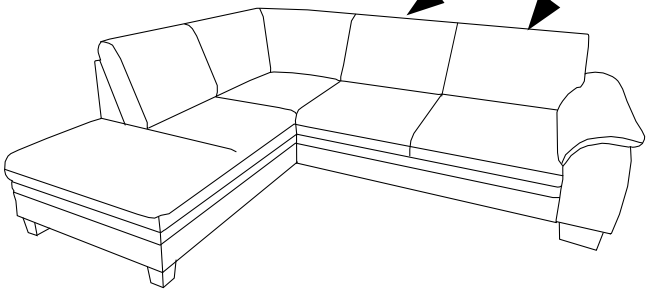
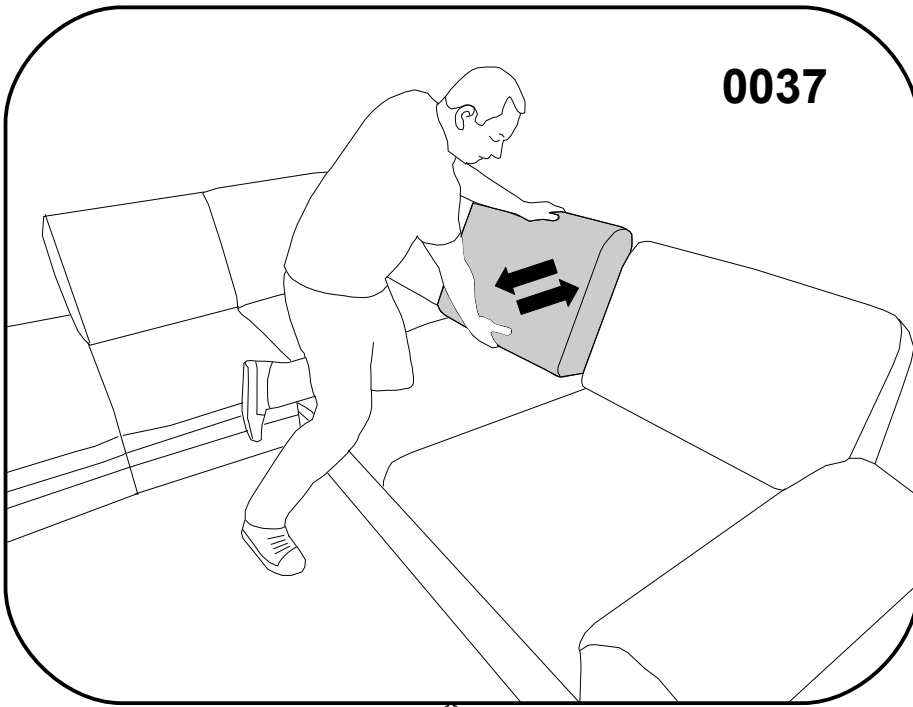

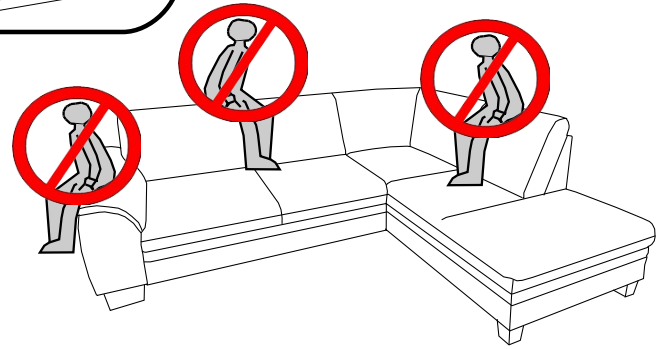
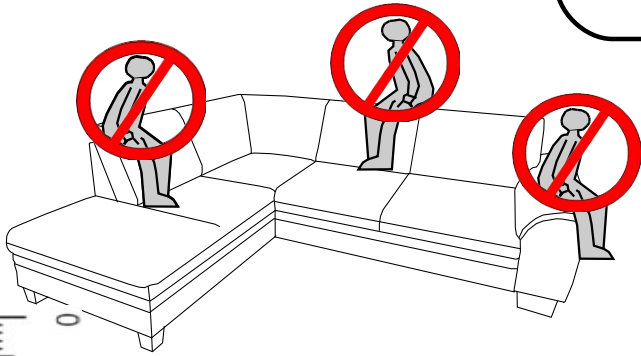
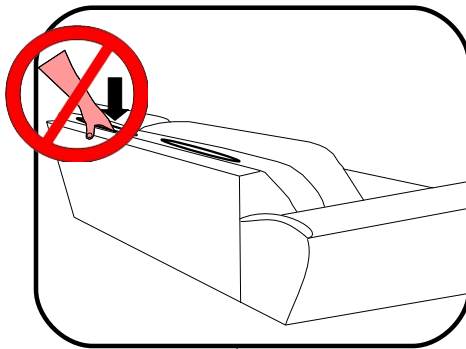

0
10
20
30
40
50
60
70
80
90
100
110
120
130
140
150
160
170
180
190
200

i L-5	f H-100	g H-100	q M8*80	x Fi-50	[mm]
X1	X4	X3	X4	X4	

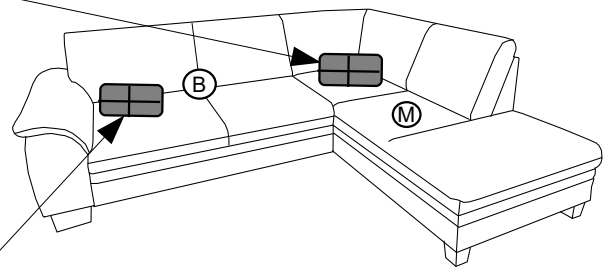
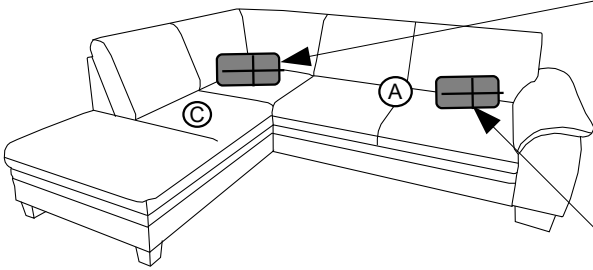



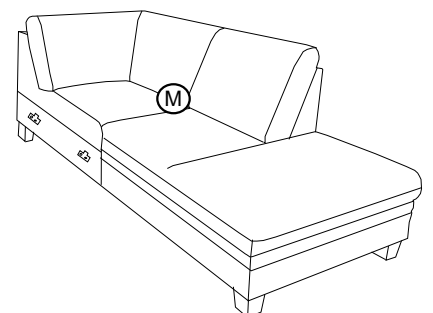
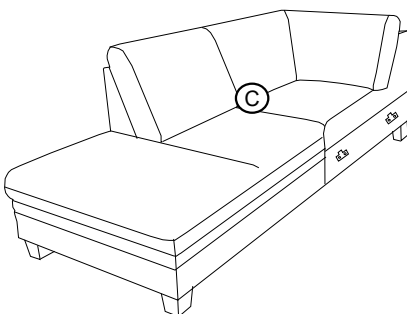
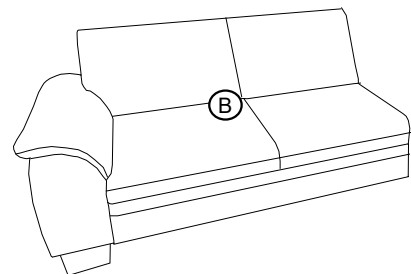
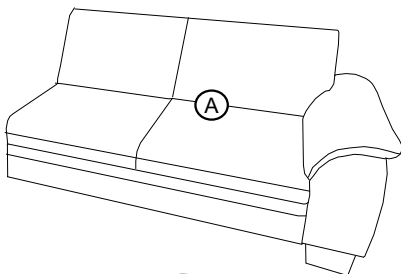

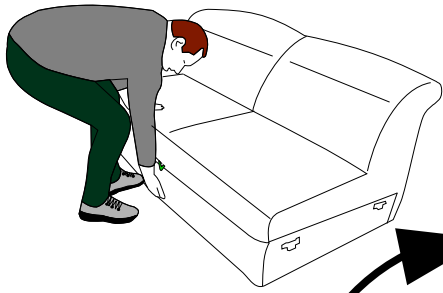
x Fi-50	s H-100	q M8*80	[mm]
X4	X2	X4	









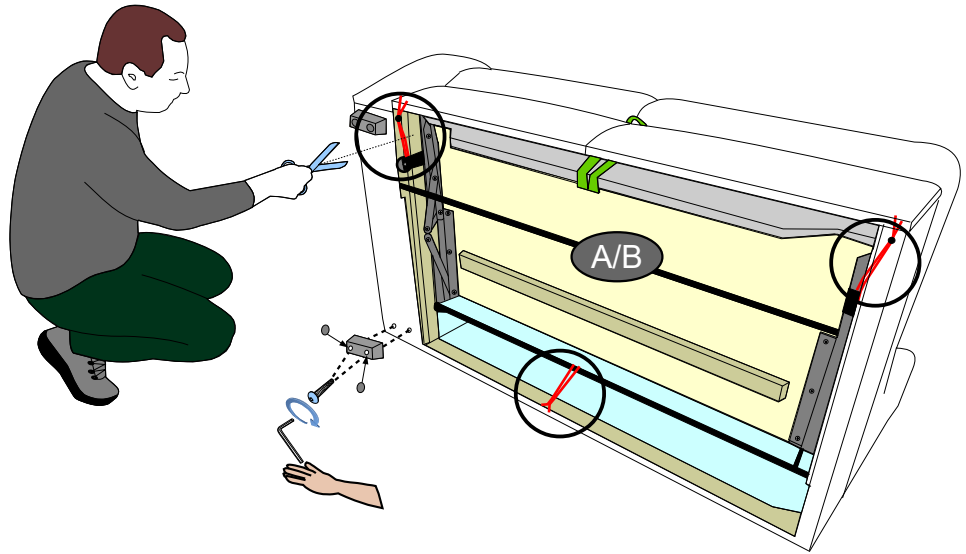



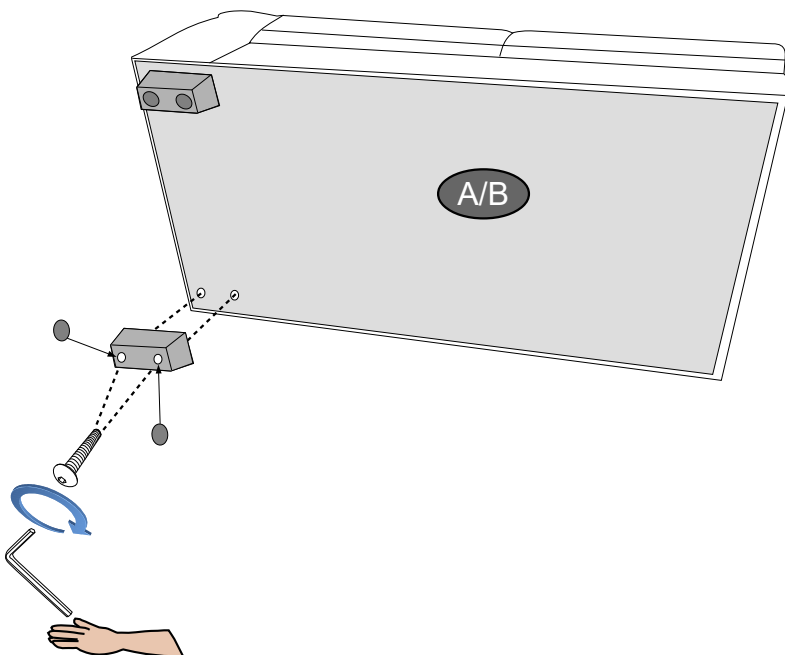

90°

X Fi- 50  X4	s H- 100  X2	q M8*80  X4	i L- 5  X1
--	--	---	---







X Fi- 50  X4	s H- 100  X2	q M8*80  X4	i L- 5  X1
--	--	---	---

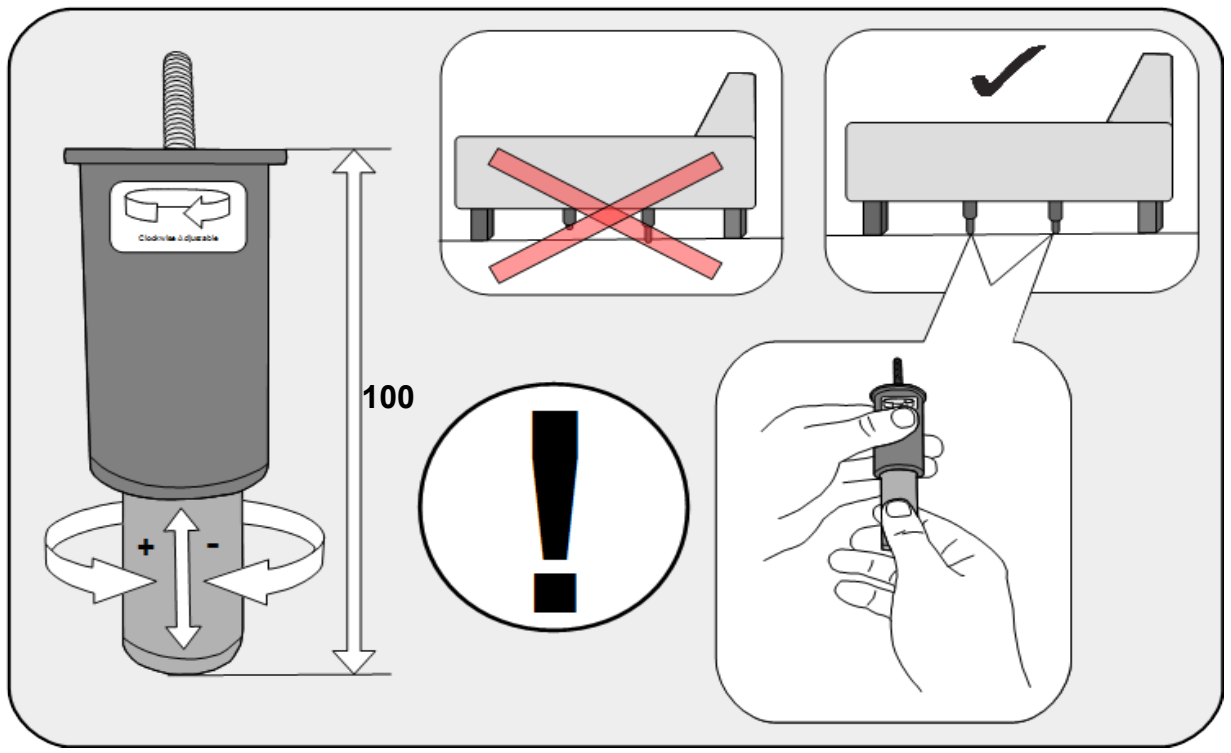
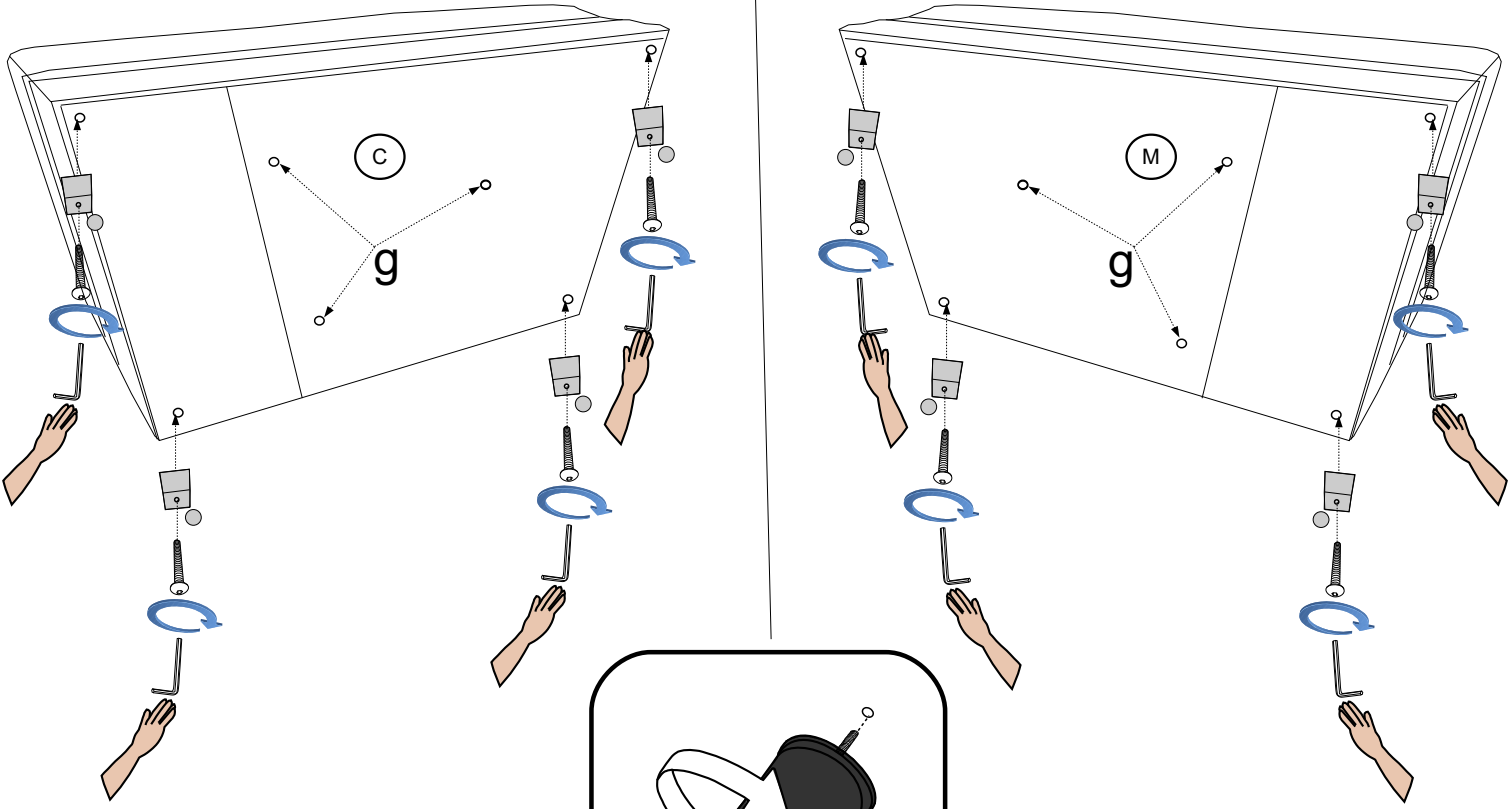

f H- 100 	g H- 100 	q M8*80 	x Fi- 50 	i L- 5 
X4	X3	X4	X4	X1



X Fi- 50  X4	S H- 100  X2	q M8*80  X4	i L- 5  X1
--	--	---	---

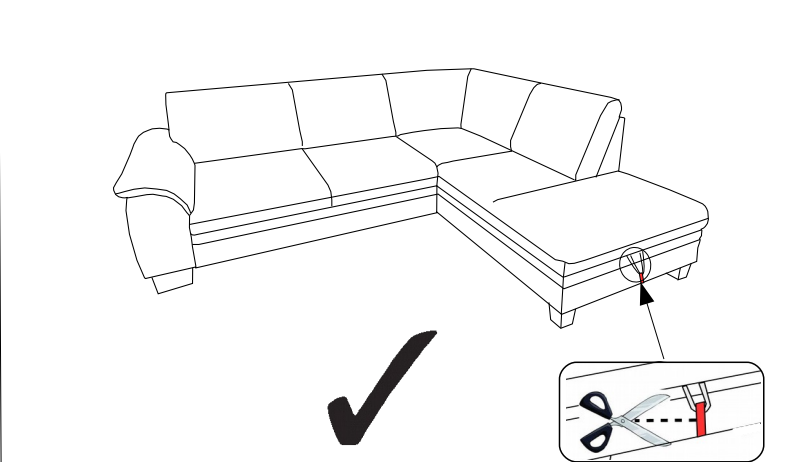
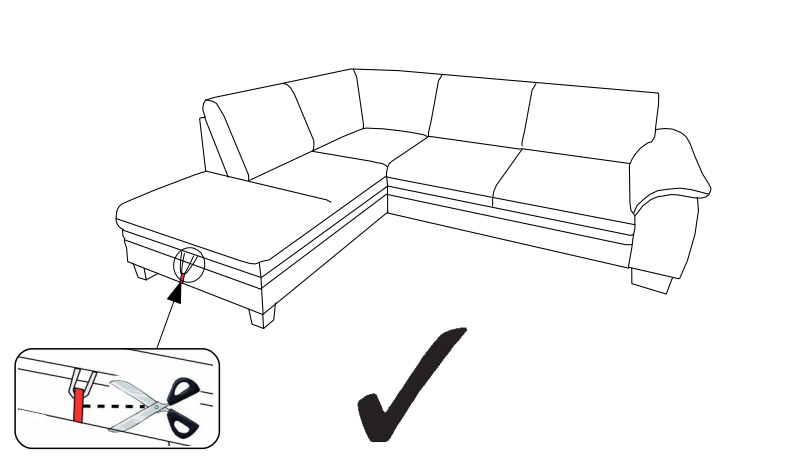
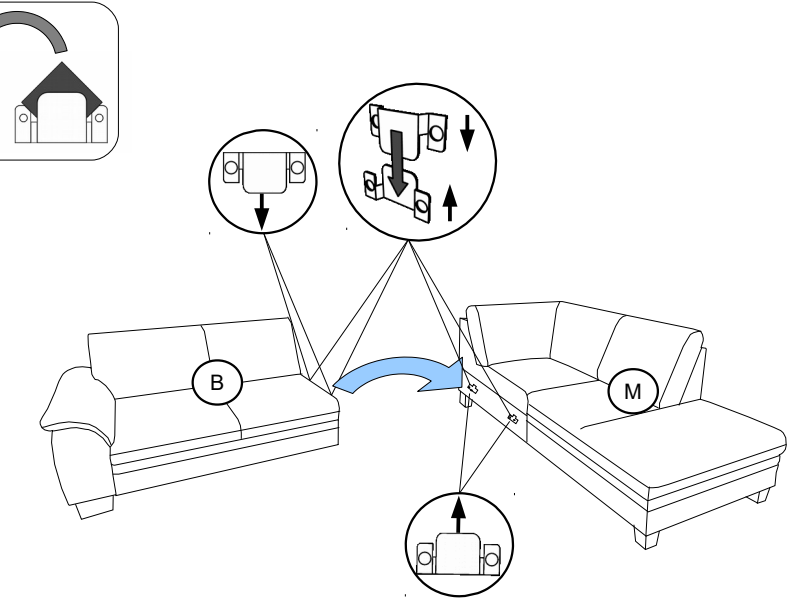
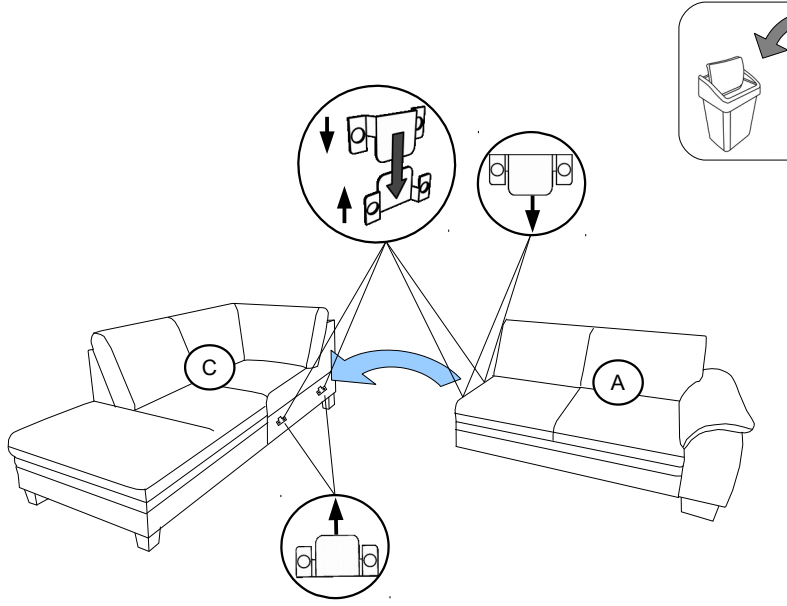
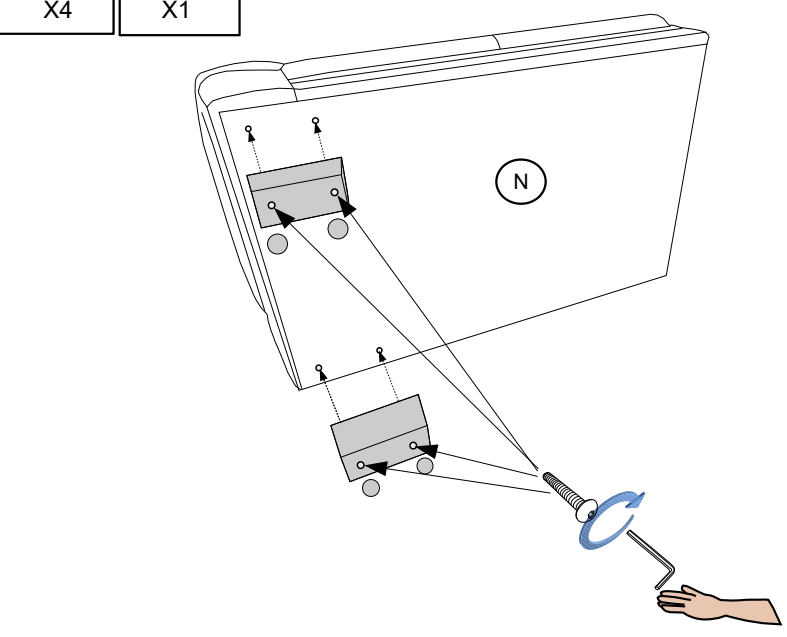
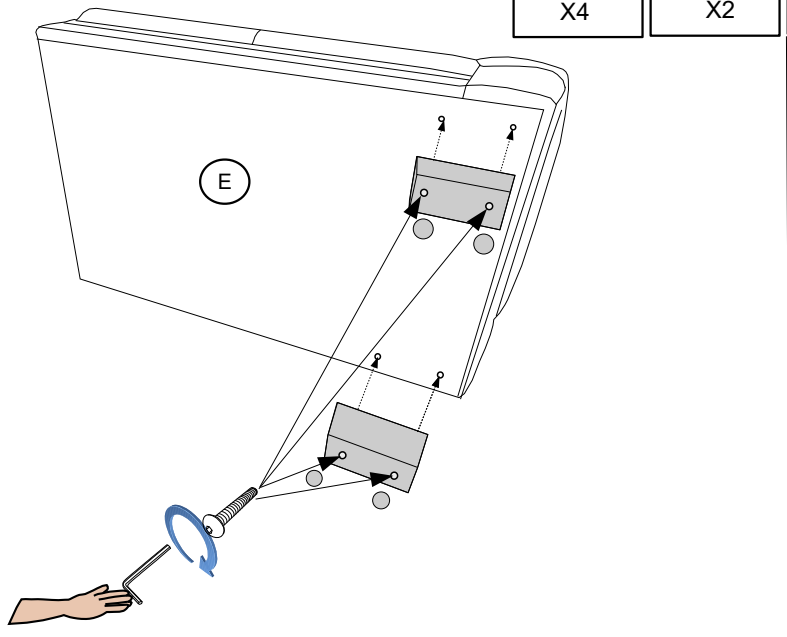

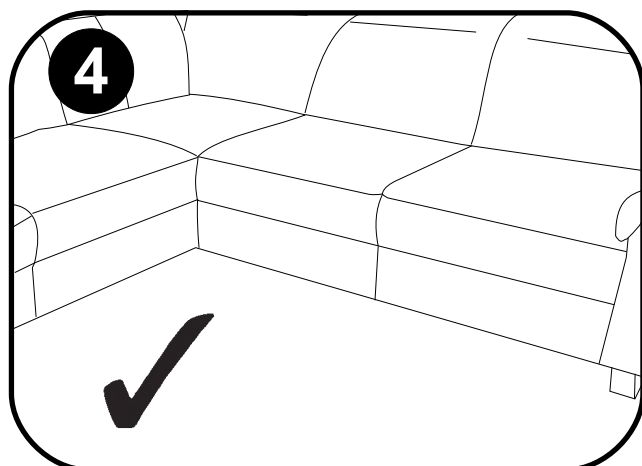
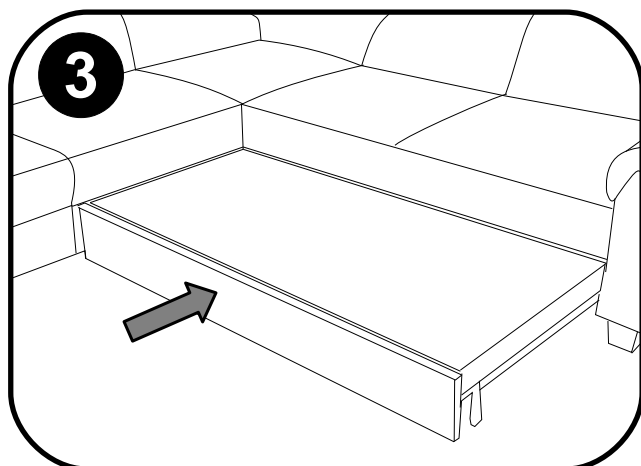
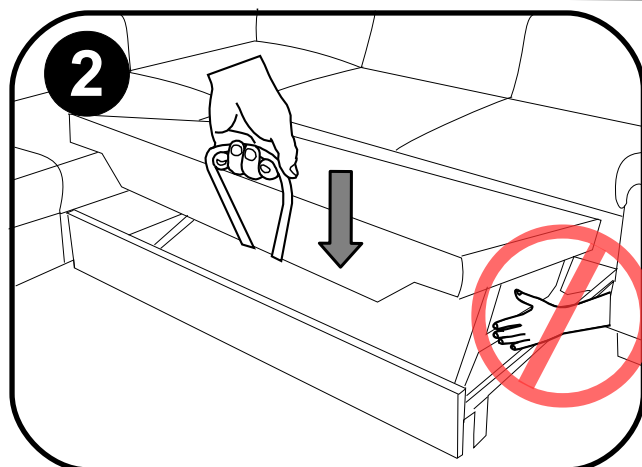
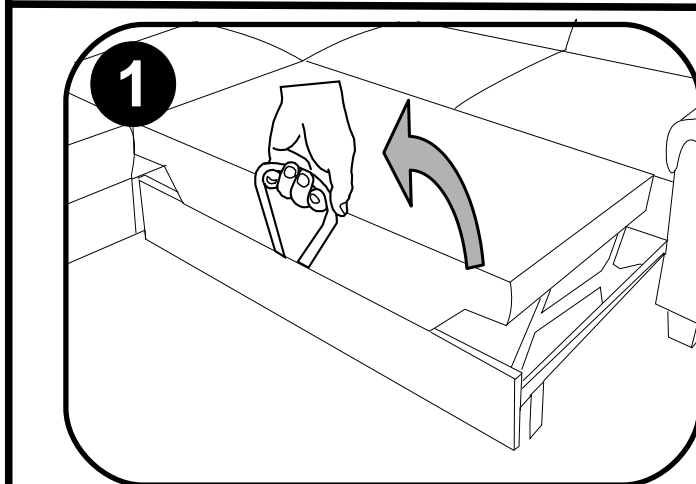
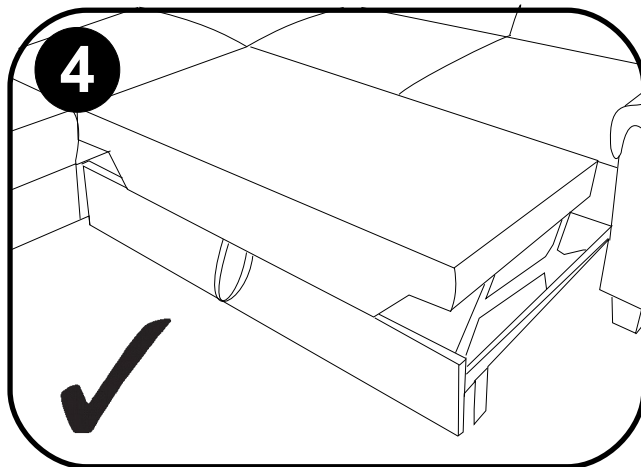
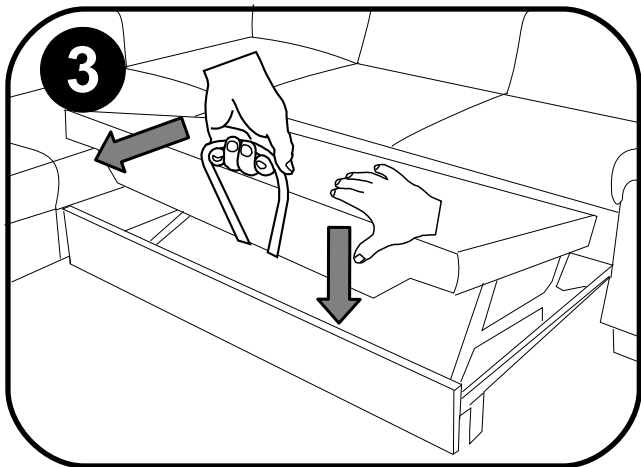
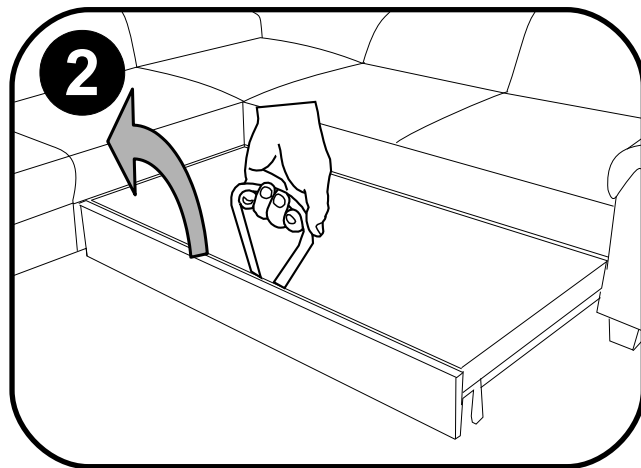
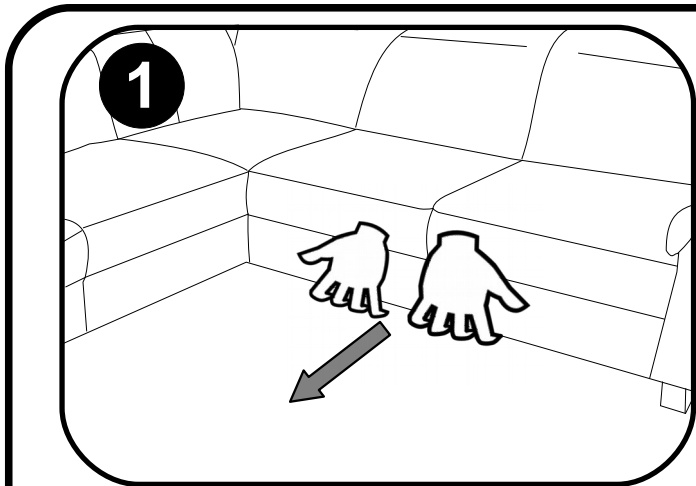
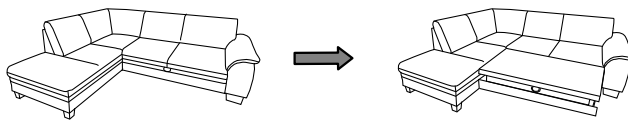





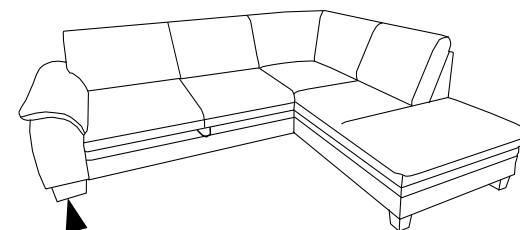
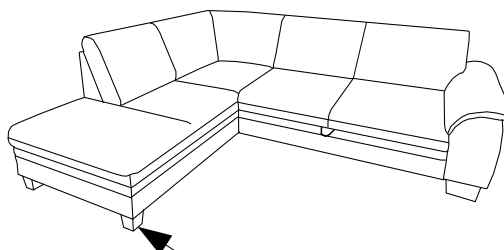
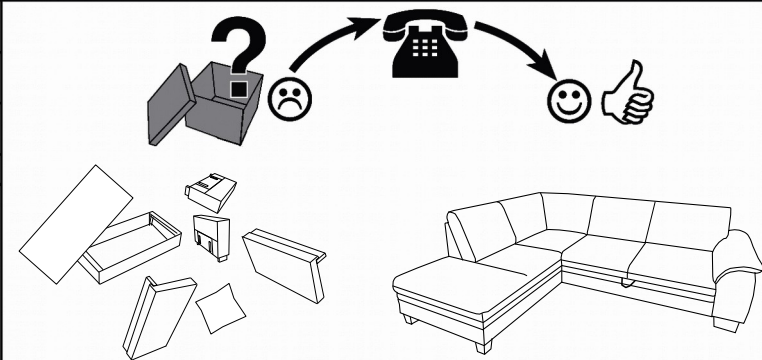
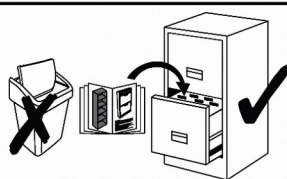

Name · Naam · Nazwa · Ísim · Название · Nume · Nome · Názov · Názov ·
 Název · Neve

HUSUM

Typ · Type · Tip · Тип · Tipo · Típus



f H- 100 	g H- 100 	q M8*80 	x Fi- 50 	s H- 100 [mm] 
--	--	---	--	--

