

XB(C)EH300
XB(C)NH300
XB(C)FH300
XB(C)WH001

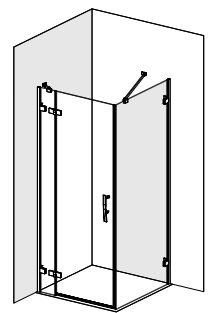

Achtung ! Gläser niemals ungeschützt auf den Boden stellen.
Verletzung der Glaskante führt zu Glasbruch.
Caution ! Never put glass walls on the floor without protection.
Damaging the glass edges results in breaking of the glass.
Attention ! Jamais placer des parois de douche en verre au sol sans
protection. Des verres endommagés casseront.

Aug. 2020 / XC

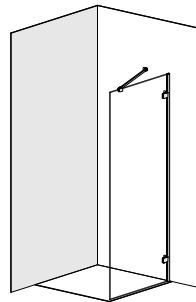
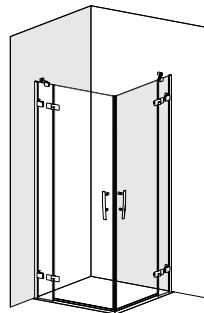
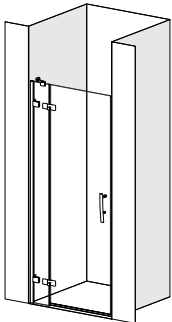
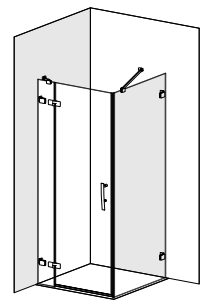
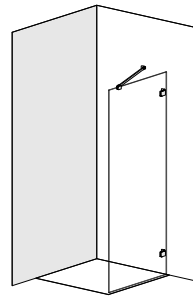
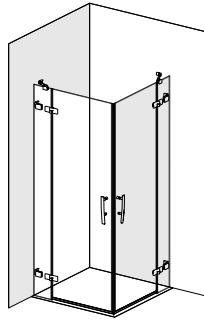
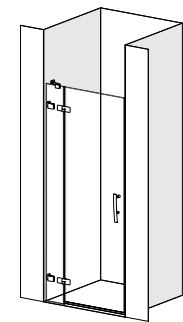

Achtung ! Gläser niemals ungeschützt auf den Boden stellen.
Verletzung der Glaskante führt zu Glasbruch.

Caution ! Never put glass walls on the floor without protection.
Damaging the glass edges results in breaking of the glass.

Attention ! Jamais plaquer des parois de douche en verre au sol sans
protection. Des verres endommagés casseront.

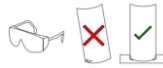

Zum Aufbau benötigen Sie
for mounting you need
pour l'installation il vous faut

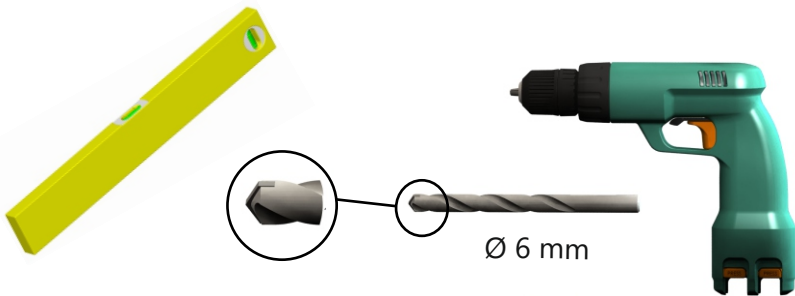
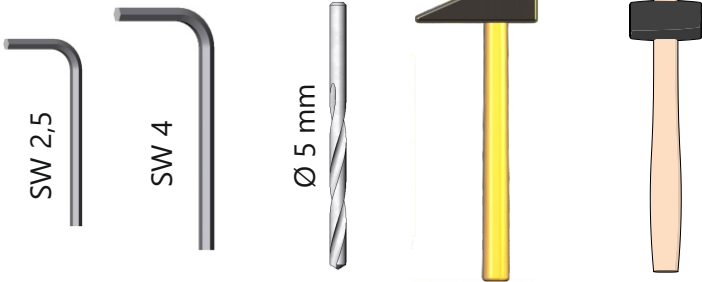

CE

Mitgeliefertes Montagematerial
supplied assembly material
matériaux pour assemblage

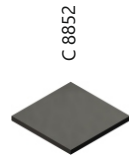
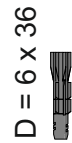
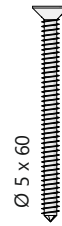

Achtung ! Gläser niemals ungeschützt auf den Boden stellen.
Verletzung der Glaskante führt zu Glasbruch.

Caution ! Never put glass walls on the floor without protection.
Damaging the glass edges results in breaking of the glass.

Attention ! Jamais placer des parois de douche en verre au sol sans protection. Des verres endommagés casseront.



EckEinstieg -- Seite 4-7
corner entry -- page 4-7
entrée d'angle -- page 4-7

XB(C)EH300

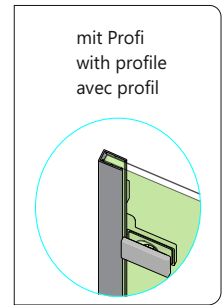
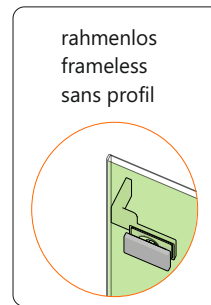
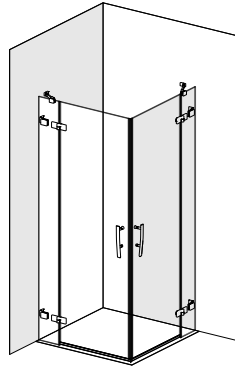

FrontEinstieg -- Seite 4-10
front entry -- page 4-10
entrée avant -- page 4-10

XB(C)FH300

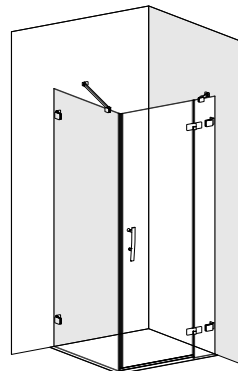
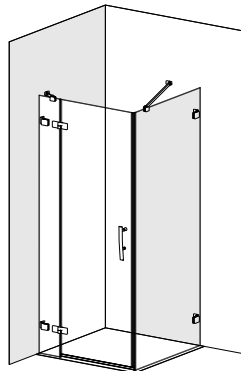

Nische -- Seite 4-7 + 11
niche -- page 4-7 + 11
niche -- page 4-7 + 11

XB(C)NH300

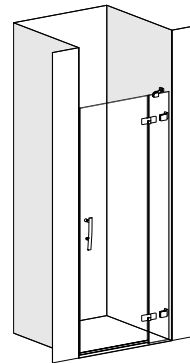
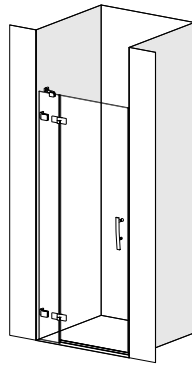

Walk-In -- Seite 8-10
walk-in -- page 8-10
walk-in -- page 8-10

XB(C)WH001

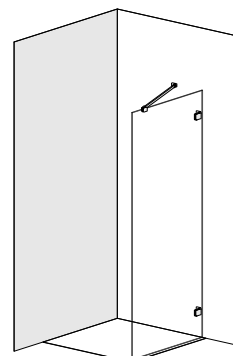
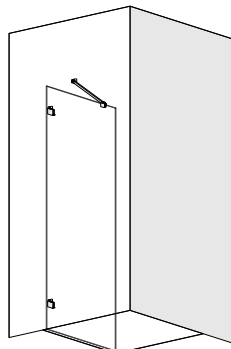

Achtung ! Gläser niemals ungeschützt auf den Boden stellen.
Verletzung der Glaskante führt zu Glasbruch.

Caution ! Never put glass walls on the floor without protection.
Damaging the glass edges results in breaking of the glass.

Attention ! Jamais plaçer des parois de douche en verre au sol sans
protéction. Des verres endommagés casseront.



Festteil + Tür
fixed part + door
partie fixe + porte

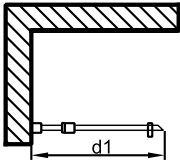

Modell	Elementmaß element dimension dimension de Élément d1 (mm)
800	770-772
900	870-872
1000	970-972

Modell	Elementmaß element dimension dimension de Élément d1 (mm)
800	772-782
900	872-882
1000	972-982

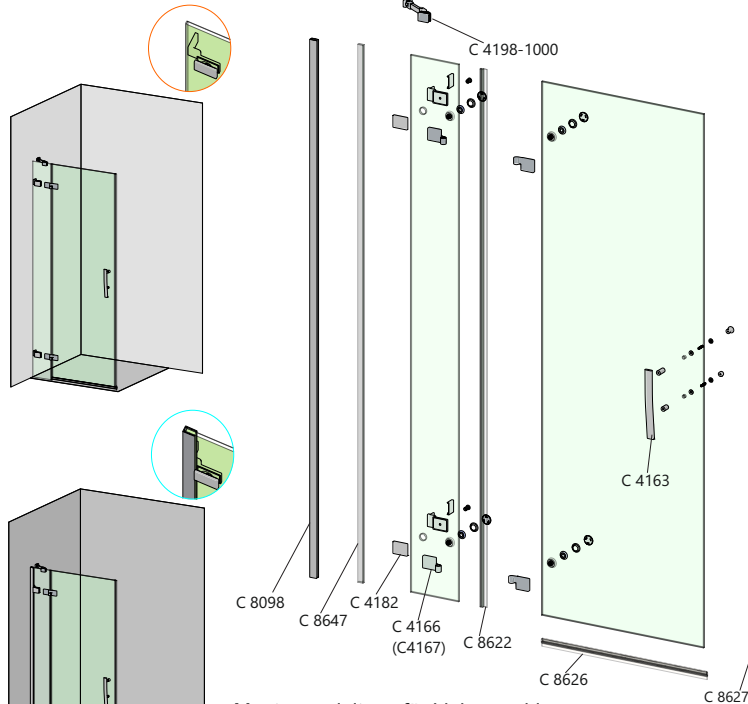

Mitteliefertes Montagematerial
supplied assembly material
matériaux pour assemblage

5.0 x 60
2x

D = 6 x 36
2x

C 8852
1x

Montageanleitung für Linksanschlag
(Rechtsanschlag = spiegelbildlich)
Assembly instructions for left hand mounting
(right hand mounting = mirror inverted)
instruction d'assemblage pour charnière à gauche
(à droite = inversé latéralement)

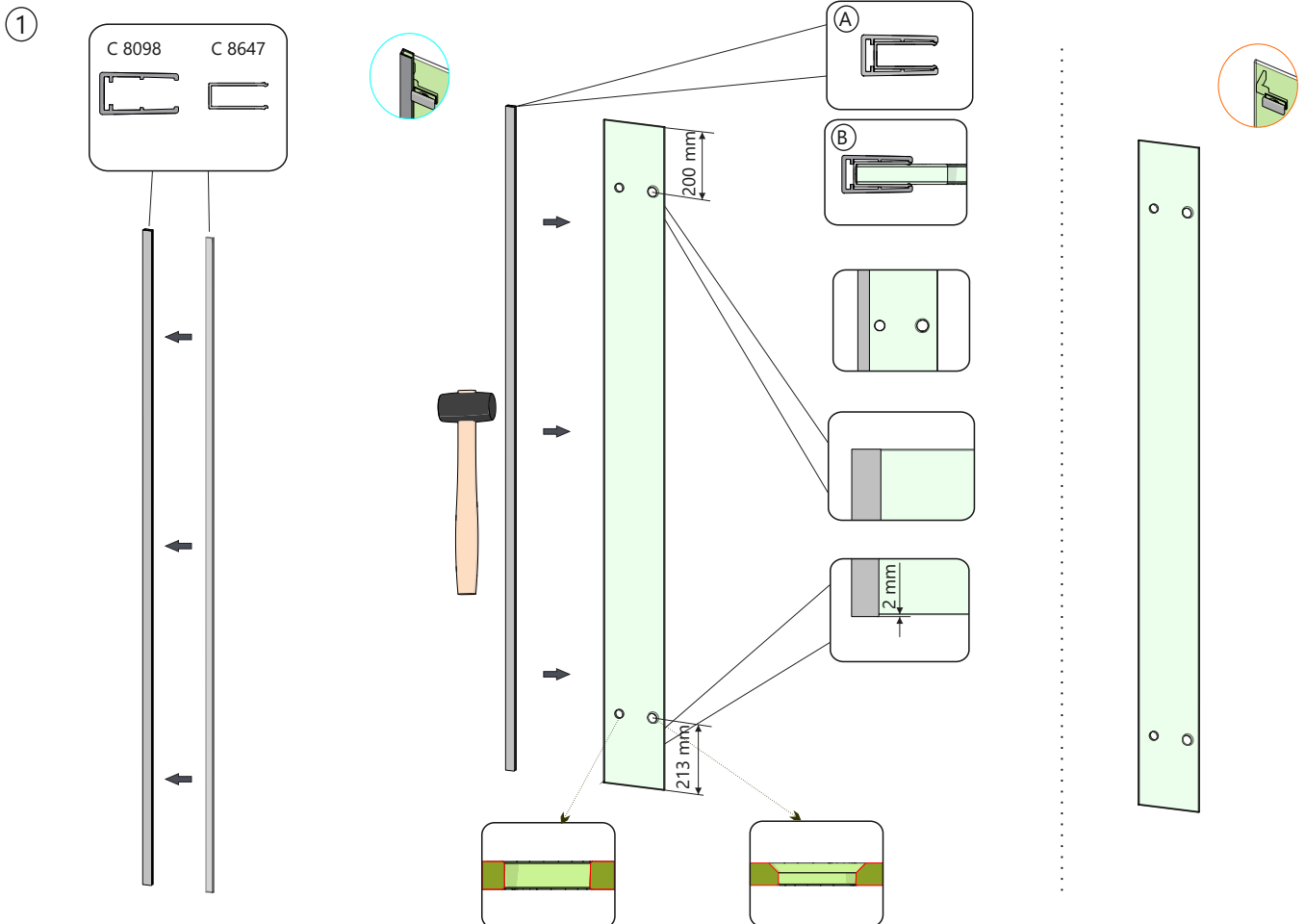

Achtung ! Gläser niemals ungeschützt auf den Boden stellen.
Verletzung der Glaskante führt zu Glasbruch.

Caution ! Never put glass walls on the floor without protection.
Damaging the glass edges results in breaking of the glass.

Attention ! Jamais placer des parois de douche en verre au sol sans
protection. Des verres endommagés casseront.

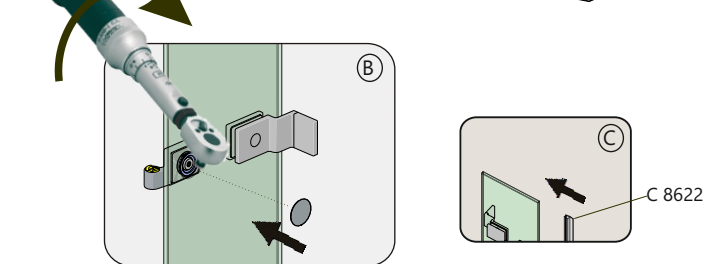
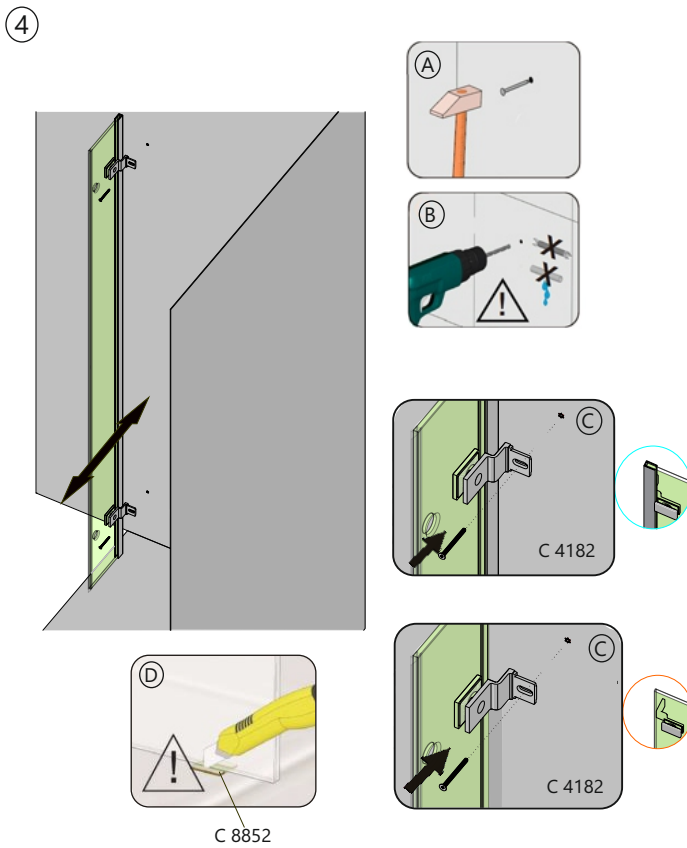
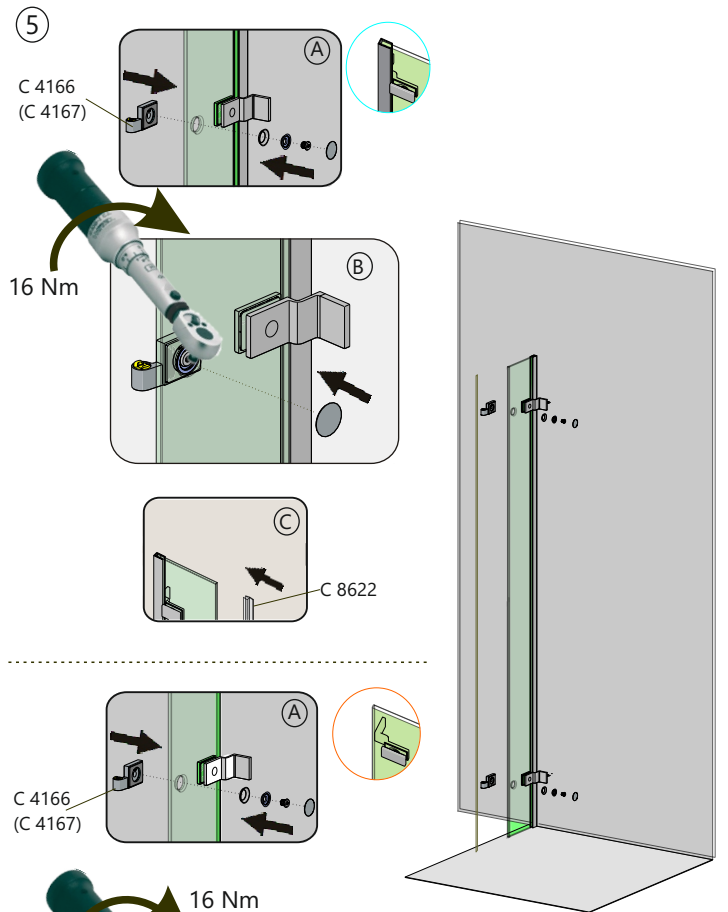
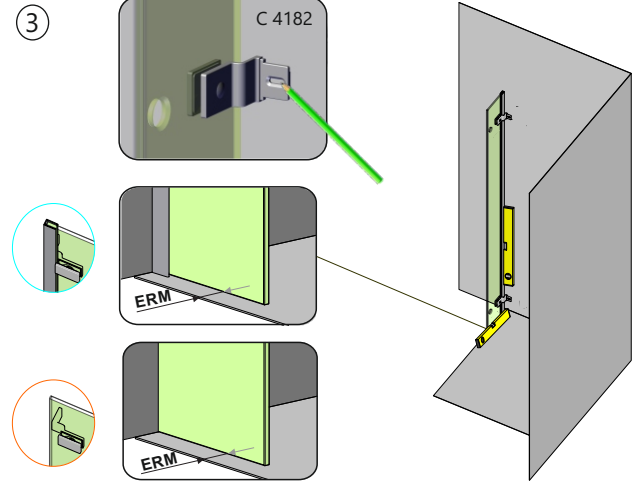
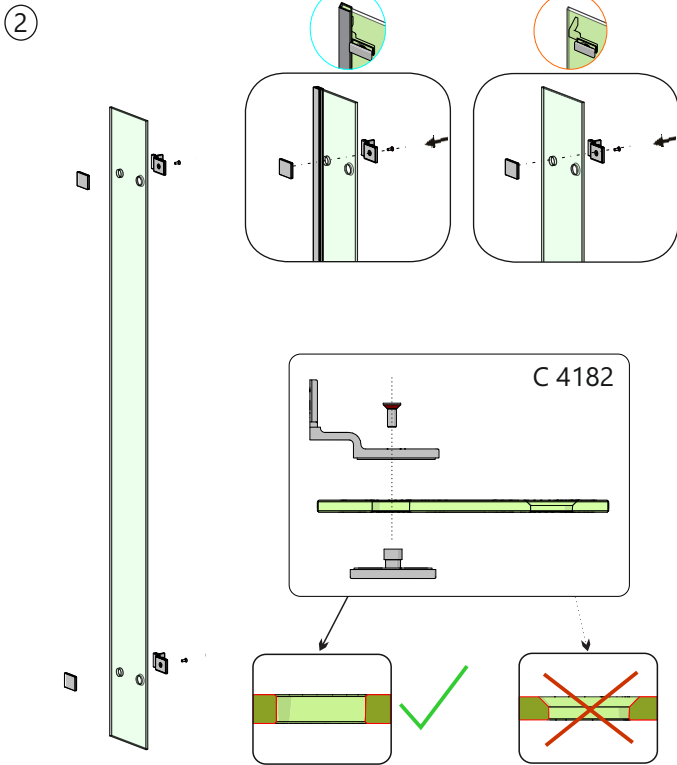

Achtung ! Gläser niemals ungeschützt auf den Boden stellen.
Verletzung der Glaskante führt zu Glasbruch.

Caution ! Never put glass walls on the floor without protection.
Damaging the glass edges results in breaking of the glass.

Attention ! Jamais placer des parois de douche en verre au sol sans protection. Des verres endommagés casseront.

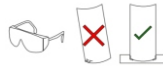

6

! Magnetprofil G8627 nur unten kürzen.
Magnet profile G8627 only shorten at bottom
Profilé magnétique raccourcir au bout au-dessous seulement.

A C 8626

B C 8627

C C 8627

D C 8627

E C 8627

F 45°

G C 4166 (C 4167)

H 16 Nm

7

A Tür / door / porte

B C 8623

C Tür / door / porte C 8622

C8627 + C8627

C8627 + C8627

8

!

A

B C 4182 C 8098

C

D

5 - 15 mm

Achtung ! Gläser niemals ungeschützt auf den Boden stellen.
Verletzung der Glaskante führt zu Glasbruch.

Caution ! Never put glass walls on the floor without protection.
Damaging the glass edges results in breaking of the glass.

Attention ! Jamais placer des parois de douche en verre au sol sans
protection. Des verres endommagés casseront.



9

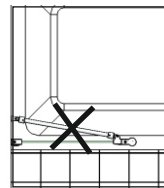
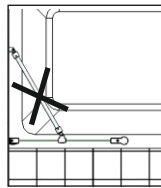
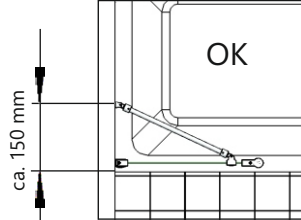
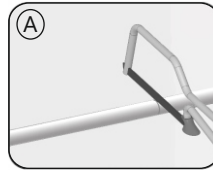
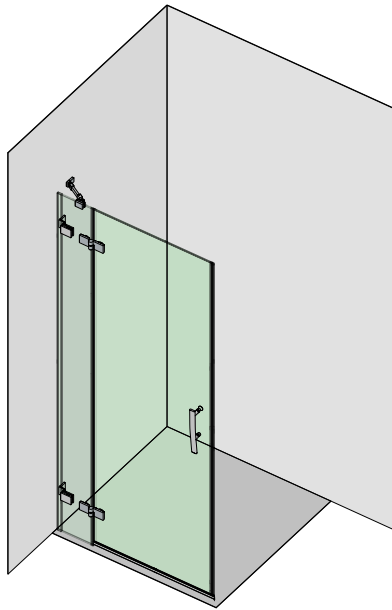

10

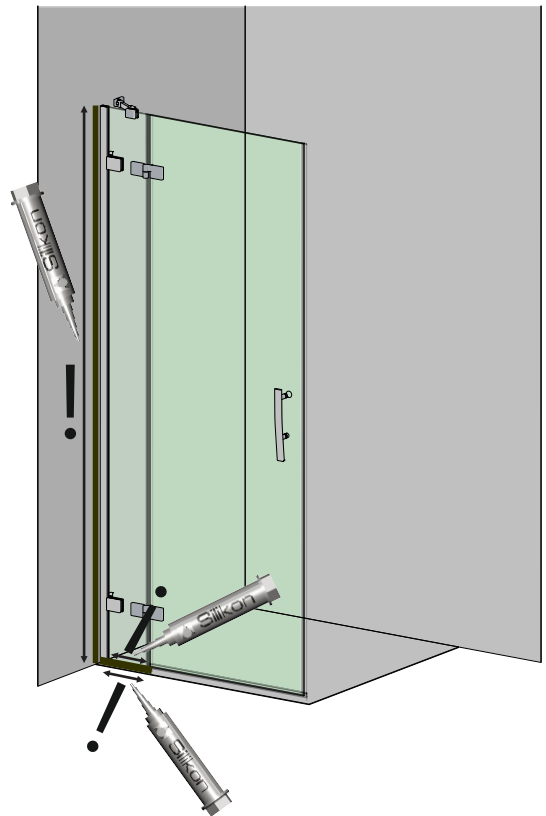
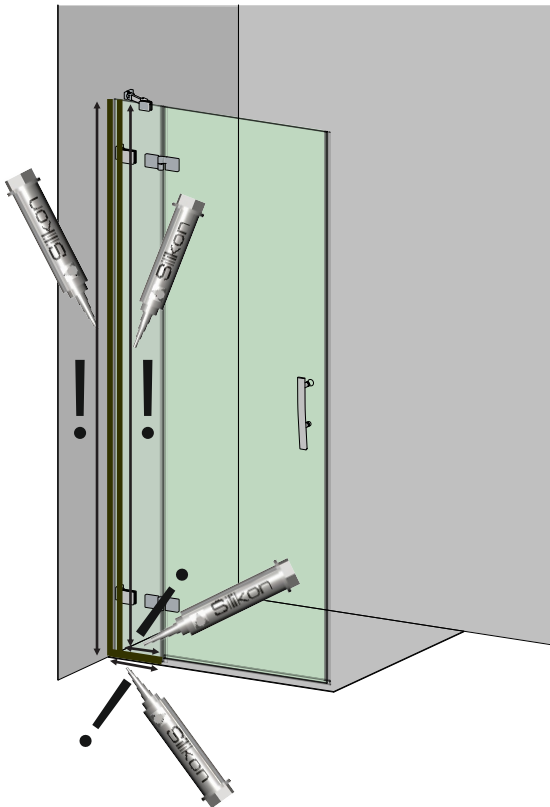
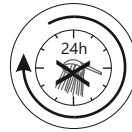

Achtung ! Gläser niemals ungeschützt auf den Boden stellen.
Verletzung der Glaskante führt zu Glasbruch.

Caution ! Never put glass walls on the floor without protection.
Damaging the glass edges results in breaking of the glass.

Attention ! Jamais plaquer des parois de douche en verre au sol sans protection. Des verres endommagés casseront.



Seitenteil side panel panneau latéral	
Modell	Elementmaß Maße inkl. Magnetprofil element dimension dimensions incl. magnetic profile dimension de l'élément dimensions avec profil magnétique d1 (mm)
800	770-772
900	870-872
1000	970-972
1200	1170-1172
1400	1370-1372

Modell	Elementmaß Maße inkl. Magnetprofil element dimension dimensions incl. magnetic Profile dimension de l'élément dimensions avec profil magnétique d1 (mm)
800	772-782
900	872-882
1000	972-982
1200	1172-1182
1400	1372-1382

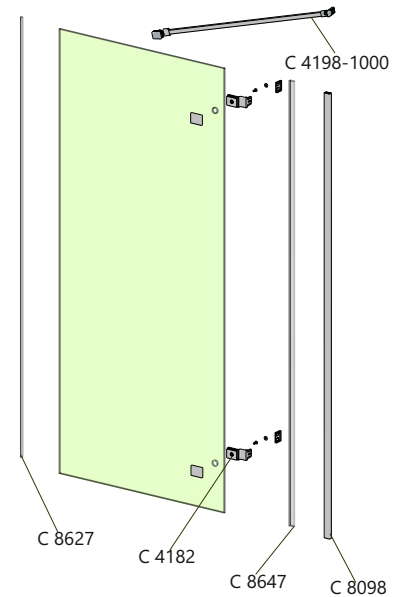
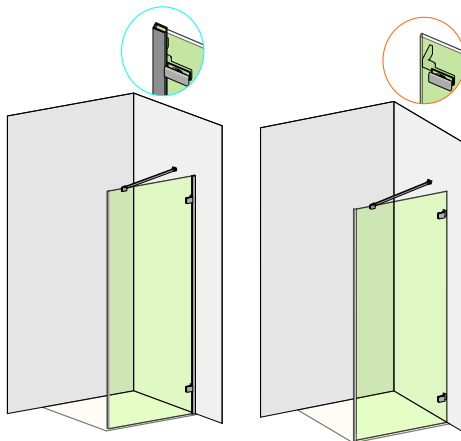

Mitgeliefertes Montagematerial
supplied assembly material
matériaux pour assemblage

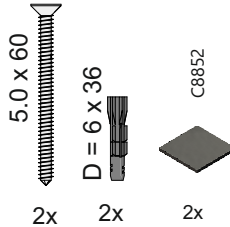

Montageanleitung für Rechtsanschlag
(Linksanschlag = spiegelbildlich)

Assembly instructions for right hand mounting
(left hand mounting = mirror inverted)

instruction d'assemblage pour charnière à droite
(à gauche = inversé latéralement)

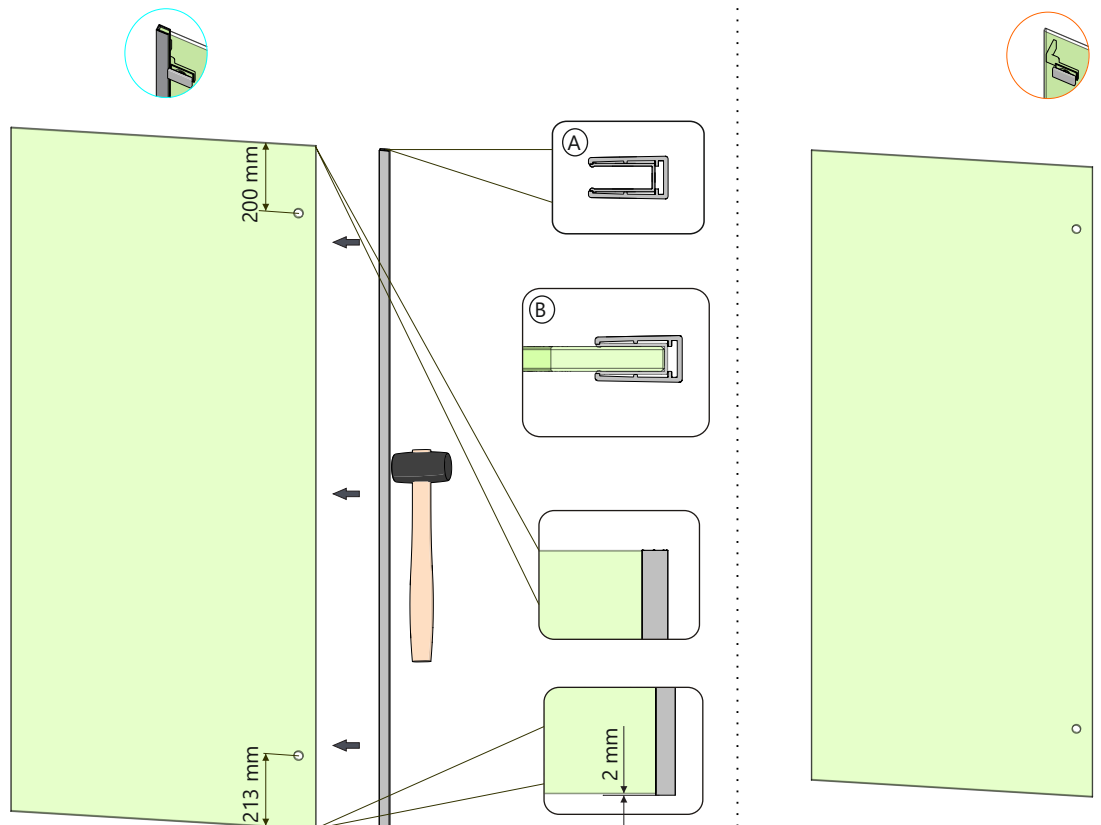
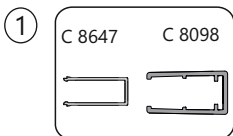

Achtung ! Gläser niemals ungeschützt auf den Boden stellen.
Verletzung der Glaskante führt zu Glasbruch.

Caution ! Never put glass walls on the floor without protection.
Damaging results in breaking of the glass.

Attention ! Jamais plaçer des parois de douche en verre au sol sans
protection. Des verres endommagés casseront.



②

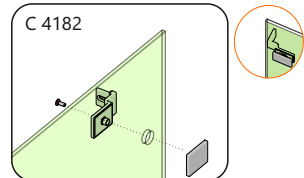
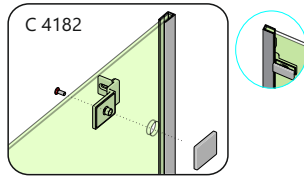
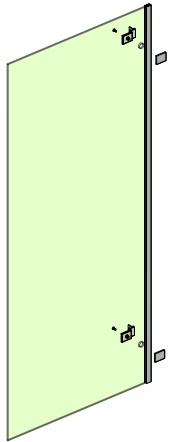

③

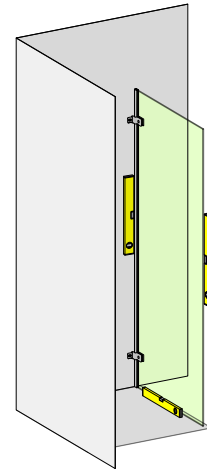
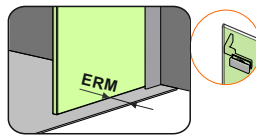
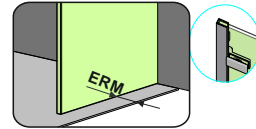
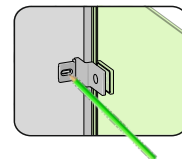

④

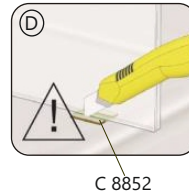
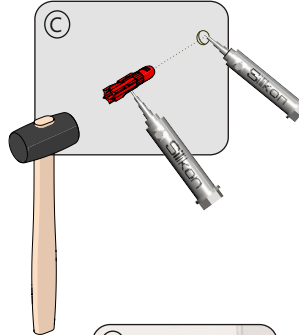
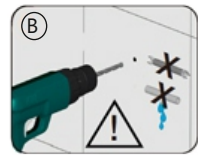
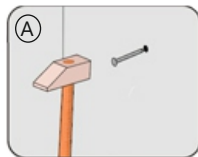
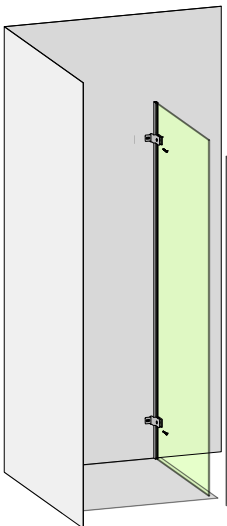

C 8852

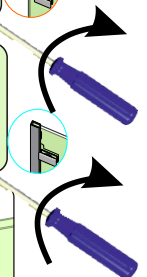
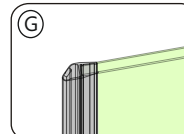
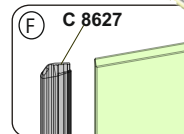
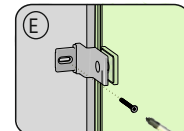
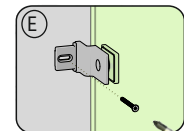

⑤

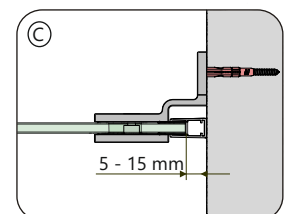
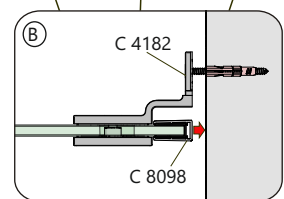
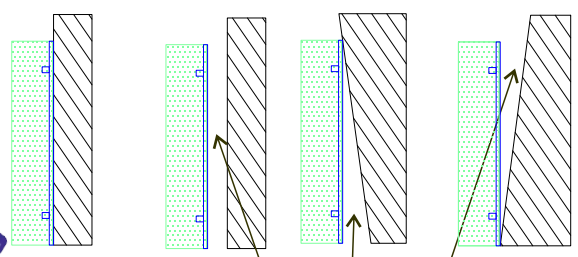
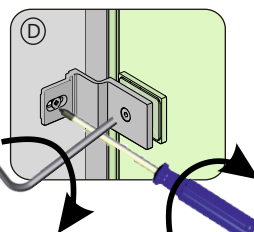
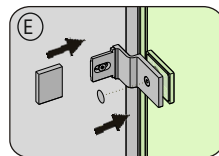
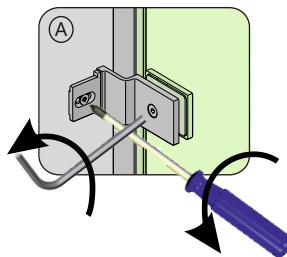
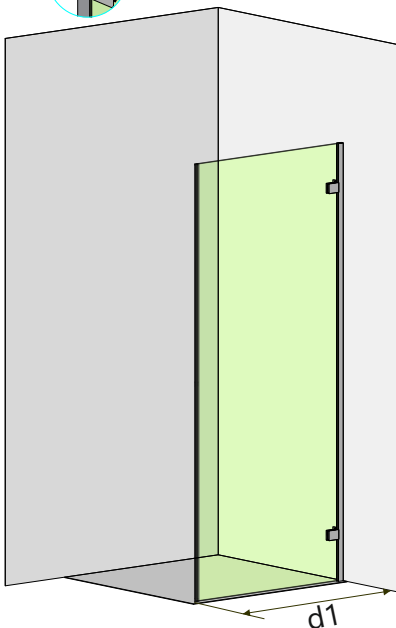

Achtung ! Gläser niemals ungeschützt auf den Boden stellen.
Verletzung der Glaskante führt zu Glasbruch.

Caution ! Never put glass walls on the floor without protection.
Damaging the glass edges results in breaking of the glass.

Attention ! Jamais placer des parois de douche en verre au sol sans protection. Des verres endommagés casseront.



⑥

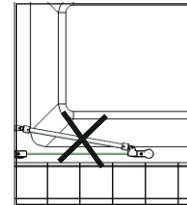
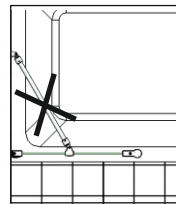
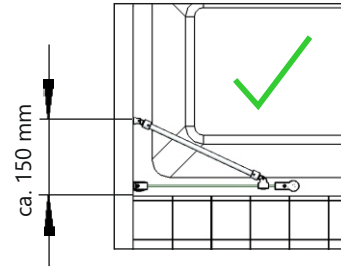
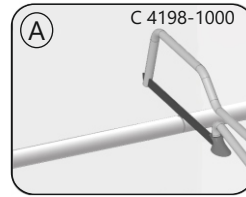
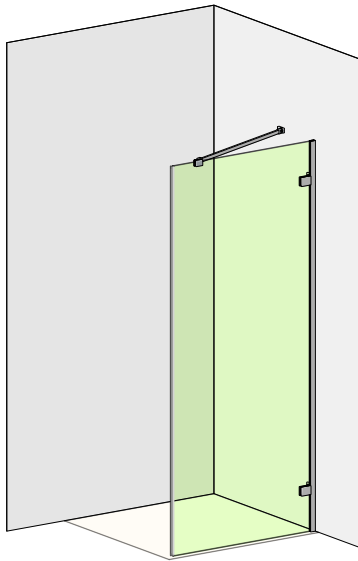

⑦

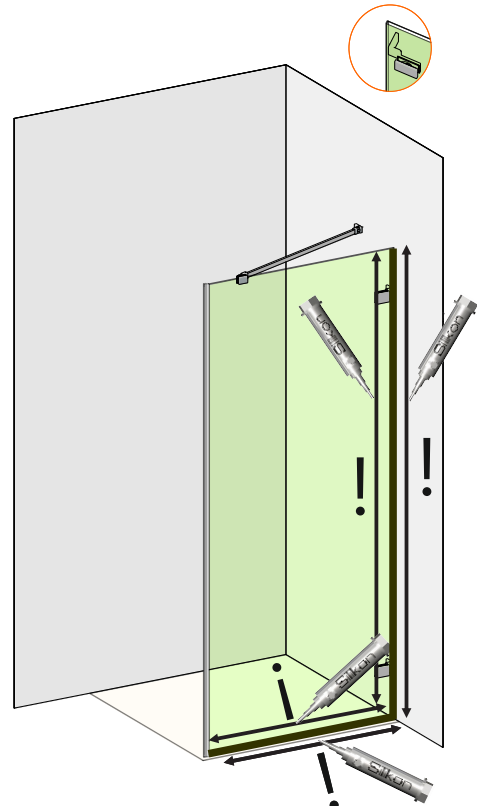
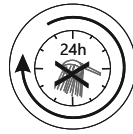
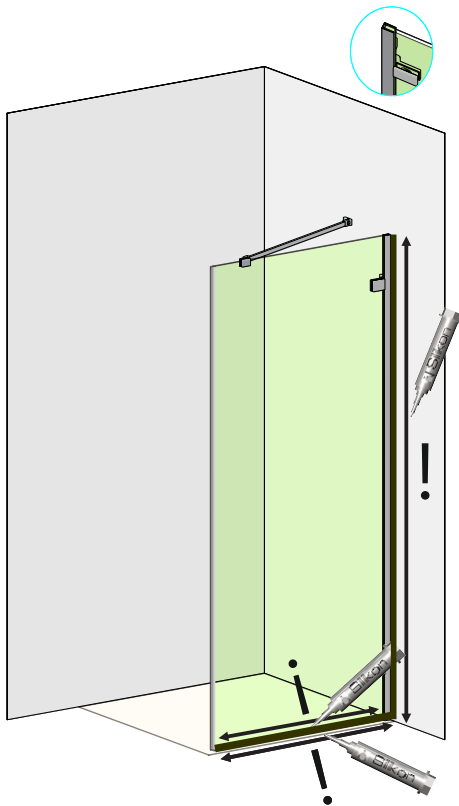

Achtung ! Gläser niemals ungeschützt auf den Boden stellen.
Verletzung der Glaskante führt zu Glasbruch.

Caution ! Never put glass walls on the floor without protection.
Damaging the glass edges results in breaking of the glass.

Attention ! Jamais placer des parois de douche en verre au sol sans protection. Des verres endommagés casseront.

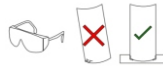

Festteil+Tür
Fixed part + door
Partie fixe + porte

Modell	Elementmaß element dimension dimension de l'élément d1 (mm)
800	781-791
900	881-891
1000	981-991

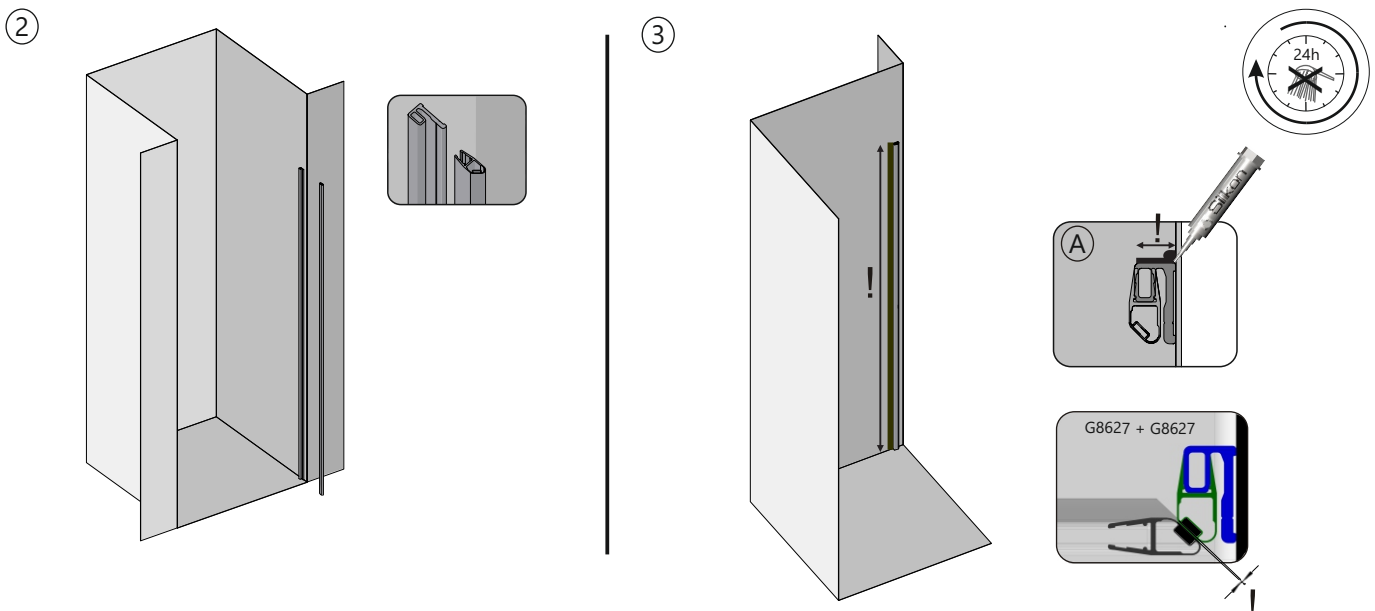
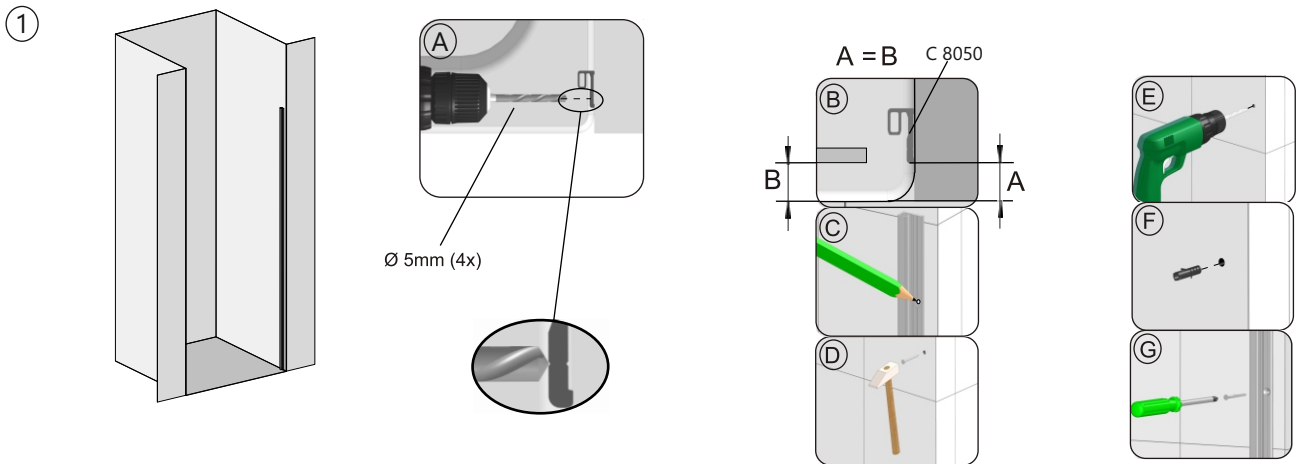
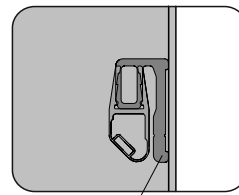
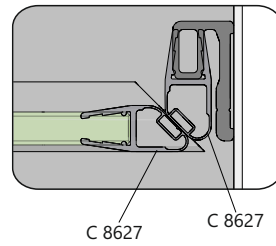
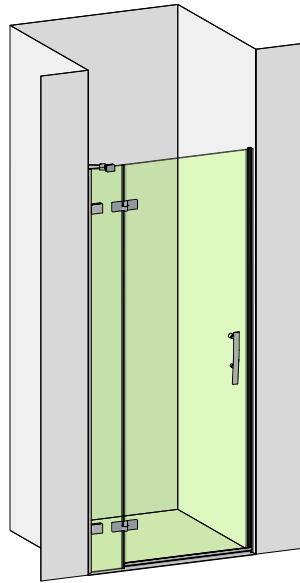

Achtung ! Gläser niemals ungeschützt auf den Boden stellen.
Verletzung der Glaskante führt zu Glasbruch.

Caution ! Never put glass walls on the floor without protection.
Damaging the glass edges results in breaking of the glass.

Attention ! Jamais placer des parois de douche en verre au sol sans protection. Des verres endommagés casseront.

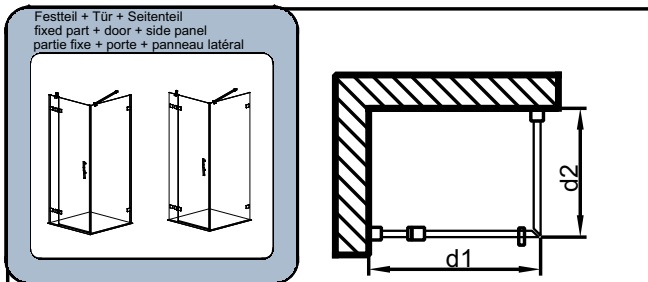
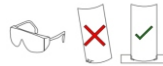

Modell	Duschasseneinbaumaß shower tray bases installation dimensions receveurs de douche dimension d'installation	Einrückmaß indent dimension dimension de retrait ERM	Elementmaß element dimension dimension de l'élément d1	Duschasse shower tray receveur de douche
800	785-787	15	770-772	800er 785 bis 802
800	790-792	20	770-772	
800	795-797	25	770-772	
800	800-802	30	770-772	
900	885-887	15	870-872	900er 885 bis 902
900	890-892	20	870-872	
900	895-897	25	870-872	
900	900-902	30	870-872	
1000	985-987	15	970-972	1000er 985 bis 1002
1000	990-992	20	970-972	
1000	995-997	25	970-972	
1000	1000-1002	30	970-972	

Modell	Duschasseneinbaumaß shower tray bases installation dimensions receveurs de douche dimension d'installation	Einrückmaß indent dimension dimension de retrait ERM	Elementmaß element dimension dimension de l'élément d1	Duschasse shower tray receveur de douche
800	787-797	15	772-782	800er 787 bis 812
800	792-802	20	772-782	
800	797-807	25	772-782	
800	802-812	30	772-782	
900	887-897	15	872-882	900er 887 bis 912
900	892-902	20	872-882	
900	897-907	25	872-882	
900	902-912	30	872-882	
1000	987-997	15	972-982	1000er 987 bis 1012
1000	992-1002	20	972-982	
1000	997-1007	25	972-982	
1000	1002-1012	30	972-982	

Modell	Duschasseneinbaumaß shower tray bases installation dimensions receveurs de douche dimension d'installation	Einrückmaß indent dimension dimension de retrait ERM	Elementmaß element dimension dimension de l'élément d2	Duschasse shower tray receveur de douche
800	785-787	15	770-772	800er 785 bis 802
800	790-792	20	770-772	
800	795-797	25	770-772	
800	800-802	30	770-772	
900	885-887	15	870-872	900er 885 bis 902
900	890-892	20	870-872	
900	895-897	25	870-872	
900	900-902	30	870-872	
1000	985-987	15	970-972	1000er 985 bis 1002
1000	990-992	20	970-972	
1000	995-997	25	970-972	
1000	1000-1002	30	970-972	
1200	1185-1187	15	1170-1172	1200er 1185 bis 1202
1200	1190-1192	20	1170-1172	
1200	1195-1197	25	1170-1172	
1200	1200-1202	30	1170-1172	
1400	1385-1387	15	1370-1372	1400er 1385 bis 1402
1400	1390-1392	20	1370-1372	
1400	1395-1397	25	1370-1372	
1400	1400-1402	30	1370-1372	

Modell	Duschasseneinbaumaß shower tray bases installation dimensions receveurs de douche dimension d'installation	Einrückmaß indent dimension dimension de retrait ERM	Elementmaß element dimension dimension de l'élément d2	Duschasse shower tray receveur de douche
800	787-797	15	772-782	800er 787 bis 812
800	792-802	20	772-782	
800	797-807	25	772-782	
800	802-812	30	772-782	
900	887-897	15	872-882	900er 887 bis 912
900	892-902	20	872-882	
900	897-907	25	872-882	
900	902-912	30	872-882	
1000	987-997	15	972-982	1000er 987 bis 1012
1000	992-1002	20	972-982	
1000	997-1007	25	972-982	
1000	1002-1012	30	972-982	
1200	1187-1197	15	1172-1182	1200er 1187 bis 1212
1200	1192-1202	20	1172-1182	
1200	1197-1207	25	1172-1182	
1200	1202-1212	30	1172-1182	
1400	1387-1397	15	1372-1382	1400er 1387 bis 1412
1400	1392-1402	20	1372-1382	
1400	1397-1407	25	1372-1382	
1400	1402-1412	30	1372-1382	

Achtung ! Gläser niemals ungeschützt auf den Boden stellen.
Verletzung der Glaskante führt zu Glasbruch.

Caution ! Never put glass walls on the floor without protection.
Damaging the glass edges results in breaking of the glass.

Attention ! Jamais placer des parois de douche en verre au sol sans protection. Des verres endommagés casseront.

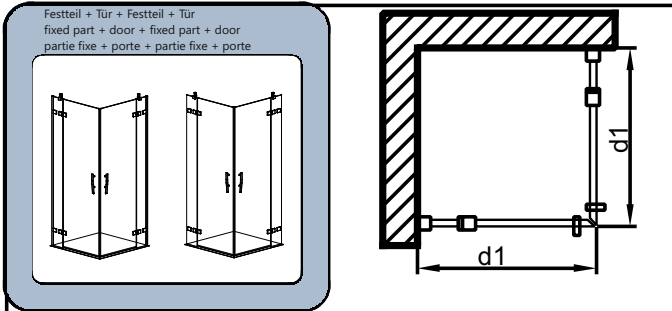

Modell	Duschtasseneinbaumaß shower tray bases installation dimensions receveurs de douche dimension d'installation	Einrückmaß indent dimension dimension de retrait ERM	Elementmaß élément dimension dimension de l'élément d1	Duschtasse shower tray receveur de douche
800	785-787	15	770-772	800er 785 bis 802
800	790-792	20	770-772	
800	795-797	25	770-772	
800	800-802	30	770-772	
900	885-887	15	870-872	900er 885 bis 902
900	890-892	20	870-872	
900	895-897	25	870-872	
900	900-902	30	870-872	
1000	985-987	15	970-972	1000er 985 bis 1002
1000	990-992	20	970-972	
1000	995-997	25	970-972	
1000	1000-1002	30	970-972	

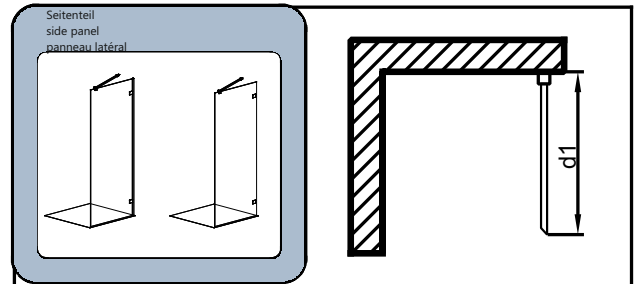

Modell	Elementmaß Maße ohne Magnetprofil élément dimension dimension without magnetic profile dimension de l'élément dimension sans profil magnétique d1	Modell	Elementmaß Maße ohne Magnetprofil élément dimension dimension without magnetic profile dimension de l'élément dimension sans profil magnétique d1
800	754-756	800	756-766
900	854-856	900	856-866
1000	954-956	1000	956-966
1200	1154-1156	1200	1156-1166
1400	1354-1356	1400	1356-1366

Modell	Duschtasseneinbaumaß shower tray bases installation dimensions receveurs de douche dimension d'installation	Einrückmaß indent dimension dimension de retrait ERM	Elementmaß élément dimension dimension de l'élément d1	Duschtasse shower tray receveur de douche
800	787-797	15	772-782	800er 787 bis 812
800	792-802	20	772-782	
800	797-807	25	772-782	
800	802-812	30	772-782	
900	887-897	15	872-882	900er 887 bis 912
900	892-902	20	872-882	
900	897-907	25	872-882	
900	902-912	30	872-882	
1000	987-997	15	972-982	1000er 987 bis 1012
1000	992-1002	20	972-982	
1000	997-1007	25	972-982	
1000	1002-1012	30	972-982	

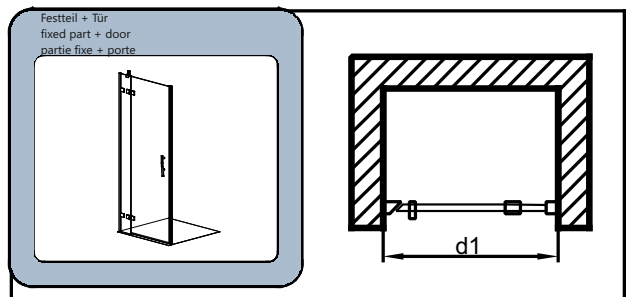

Modell	Elementmaß élément dimension dimension de l'élément d1
800	781-791
900	881-891
1000	981-991

EG-Konformitätserklärung
EC Declaration of Conformity

Hersteller/ Name und Adresse: GEO Produkte GmbH
Manufacturer/ name and address: Friedrichsfelder Straße 27
68723 Schwetzingen

Wir erklären in alleiniger Verantwortung:
We declare under our sole responsibility:

Produktbenennung: Duschabtrennung mit ESG
oder Kunststoffglas
product designation: shower enclosure with
tempered glass and acrylic-glass

Typ / Modell: alle Modelle
type / model: all models

stehen in Übereinstimmung mit den Bestimmungen der im Folgenden
genannten Richtlinie und Standards:
*are in conformity with the provisions of the following regulations and
standards:*

EN 14428:2004 + A1:2008



GEO Produkte GmbH
Friedrichsfelder Straße 27
68723 Schwetzingen /Germany
Tel. +49(0)6202 20930
FAX +49(0)6202 209399

13

DE2013/01

www.geoprodukte.com/service/leistungserklärung.html/

EN 14428

Duschabtrennung mit Einscheiben Sicherheitsglas oder Kunststoffglas
Shower wall made of *ESG tempered safety glass or sythetic glass*

Reinigbarkeit:
cleanability: Bestanden
passed

Bruch Eigenschaften:
impact resistance: Bestanden
passed

Dauerhaftigkeit:
durability: Bestanden
passed