

# Sectional Sofa









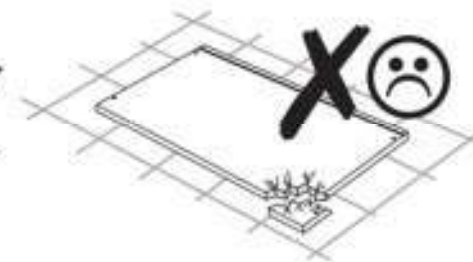
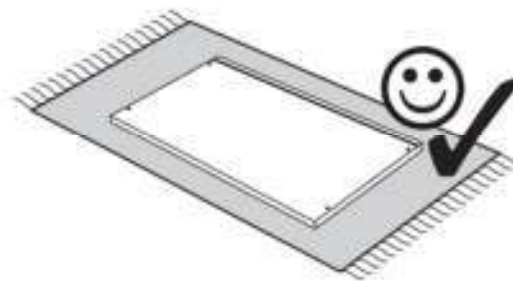
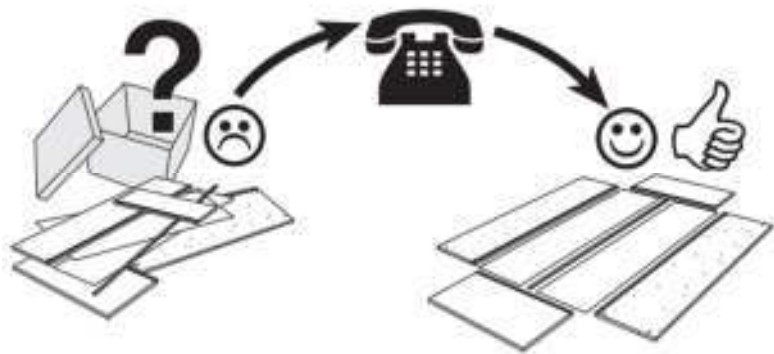

DA038

| Service • Assistenza • Dienstverlening • Serwis<br>Servis • Szerviz • Сервисная служба    |  |
|---|--|
| Name • Nom • Nome • Naam •<br>Nazwa • Jméno • Názov • Név •<br>Denumire • İsim • Название | Quincy   |
|           |  |
|          |  |

- (D) Montageanleitung
- (FR) Notice de montage
- (NL) Handleiding voor de montage
- (CZ) Montážní návod
- (HU) Szerelési útmutató
- (TR) Montaj talimati
- (GB) Assembly instructions
- (IT) Istruzioni di montaggio
- (PL) Instrukcja montażu
- (SK) Návod na montáž
- (RO) Instrucțiuni de montaj
- (RU) Инструкция по монтажу

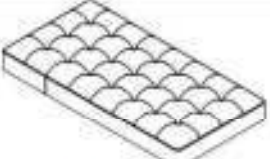
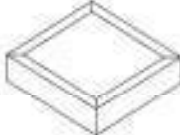



|   |   |   |   |
|---|---|---|---|
| <p><b>A</b></p>    | <p><b>B</b></p>    | <p><b>G</b></p>    | <p><b>H</b></p>    |
| <p>BACK<br/>1 PC</p>  | <p>SEAT PANEL<br/>1 PC</p>  | <p>BACK CUSHION<br/>1 PCS</p>   | <p>SUPPORT LEG<br/>1 PC</p>   |
| <p><b>C</b></p>  | <p><b>D</b></p>  | <p><b>I</b></p>  | <p><b>J</b></p>  |
| <p>FRONT RAIL<br/>1 PC</p>  | <p>LEFT ARM<br/>1 PC</p>  | <p>LONG SEAT CUSHION<br/>1 PC</p>   | <p>OTTOMAN<br/>1 PC</p>   |
| <p><b>E</b></p>  | <p><b>F</b></p>  | <p><b>K</b></p>  |   |
| <p>RIGHT ARM<br/>4 PCS</p>  | <p>SEAT CUSHION<br/>4 PCS</p>   | <p>OTTOMAN FOOT<br/>4 PCS</p>   |   |

# 1

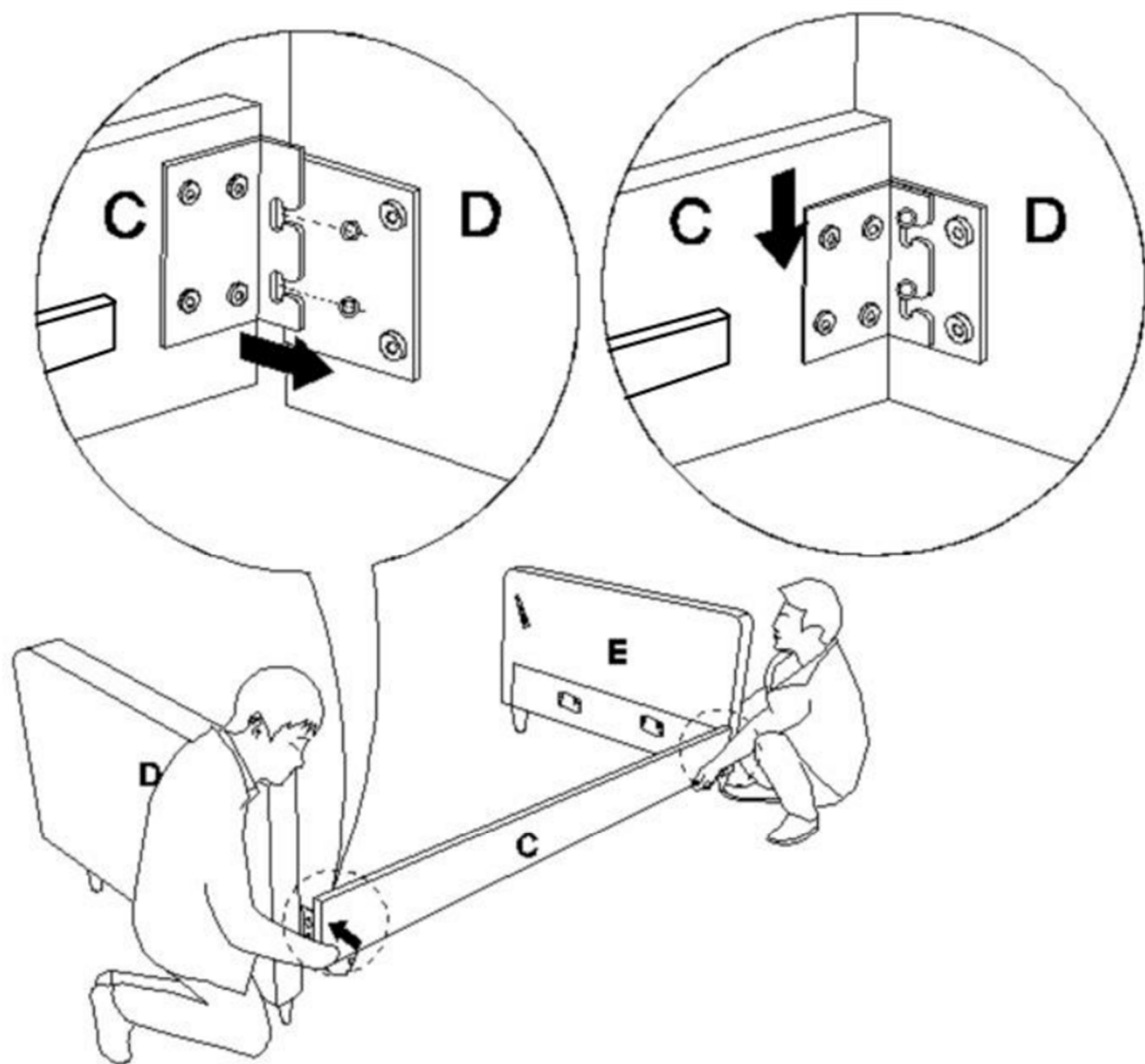

2

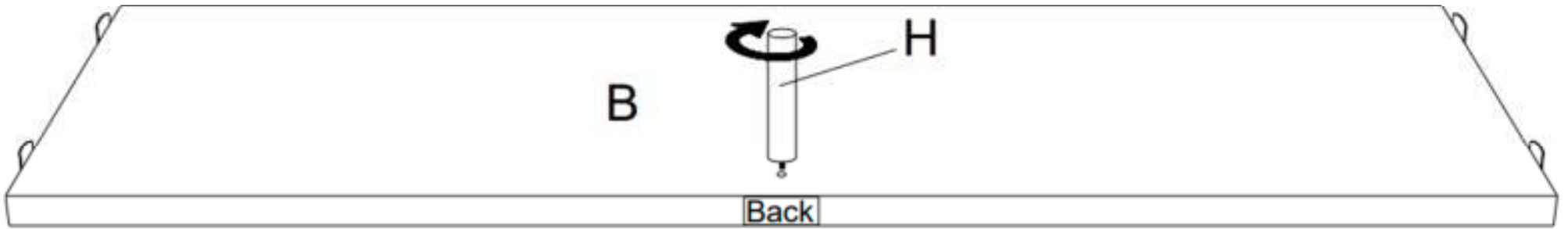
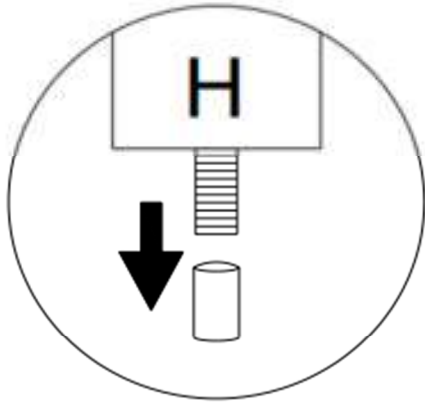

3

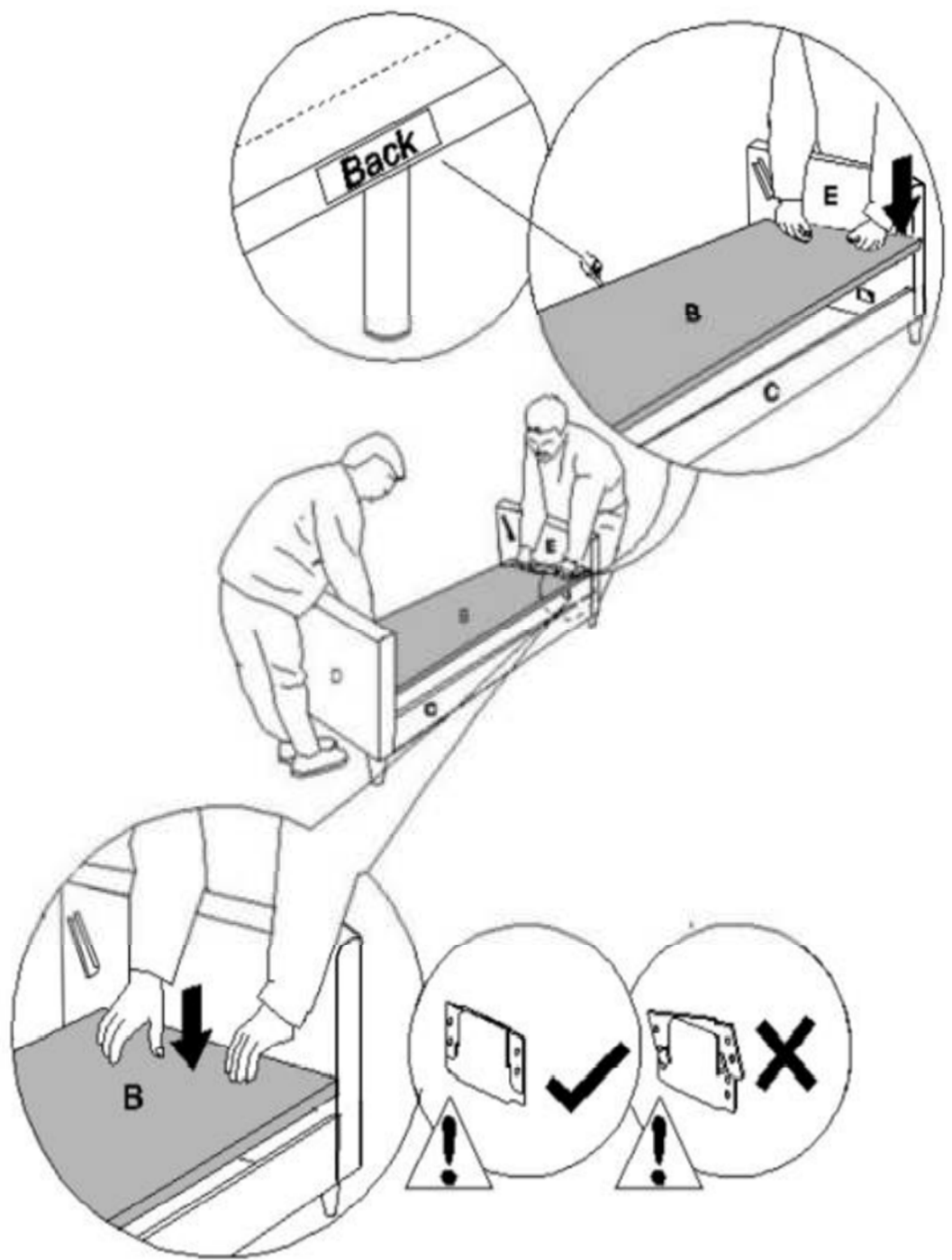

4

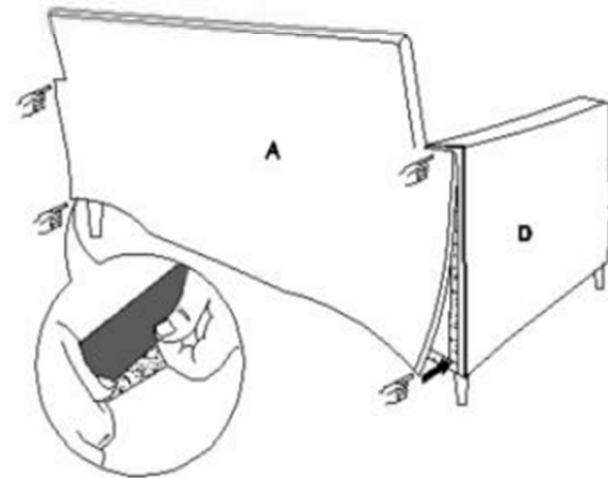
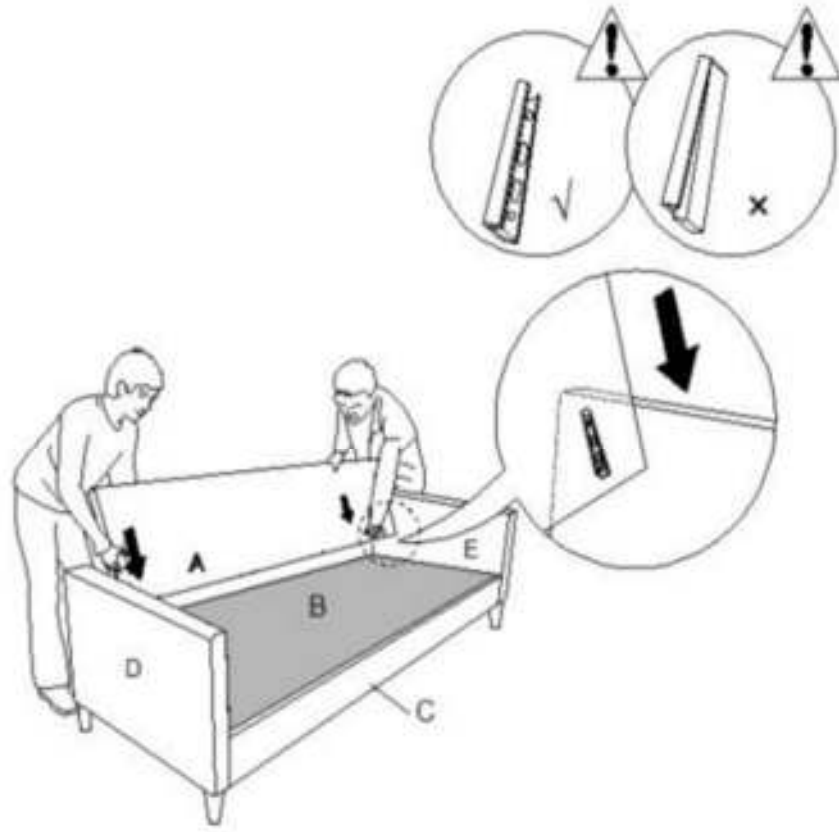

5

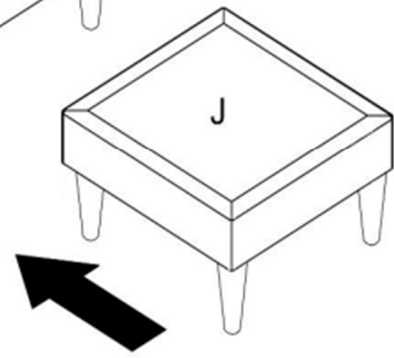
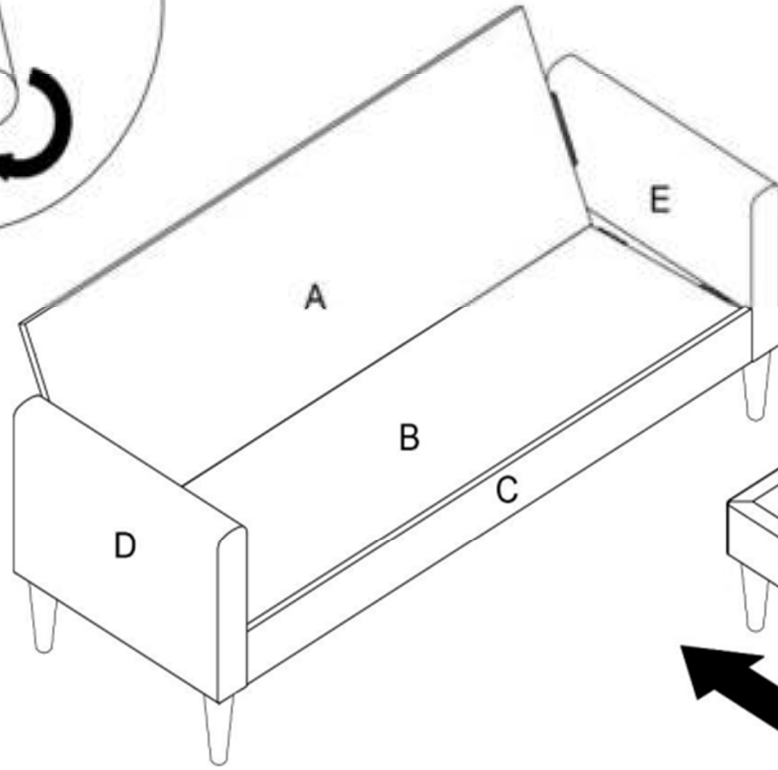
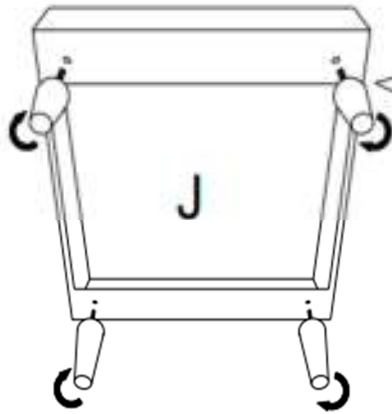
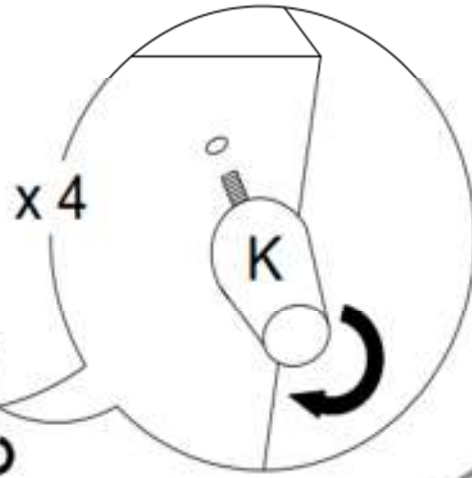
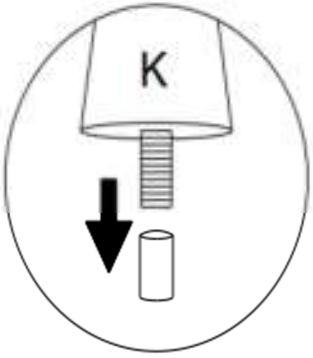

6

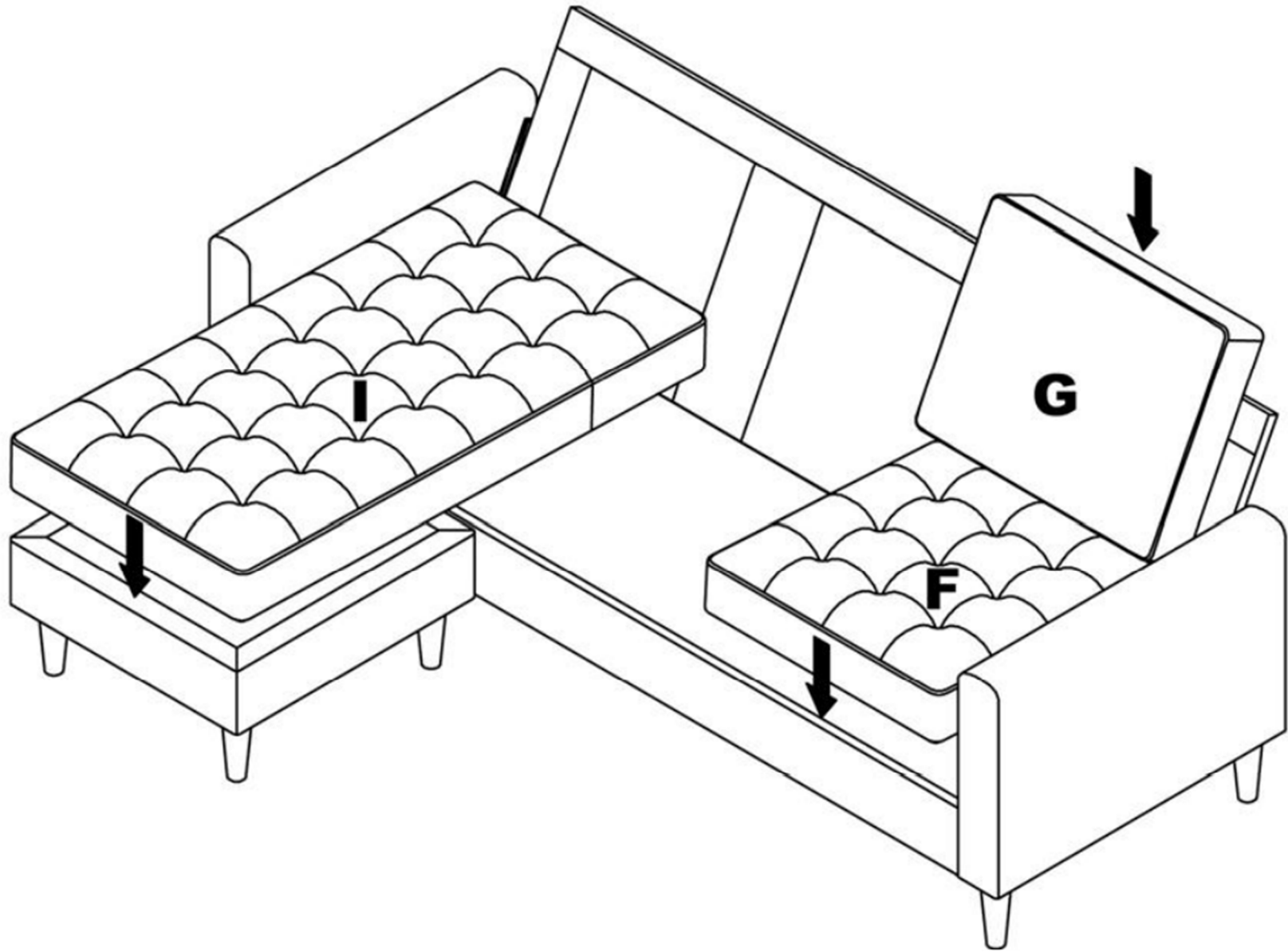



7

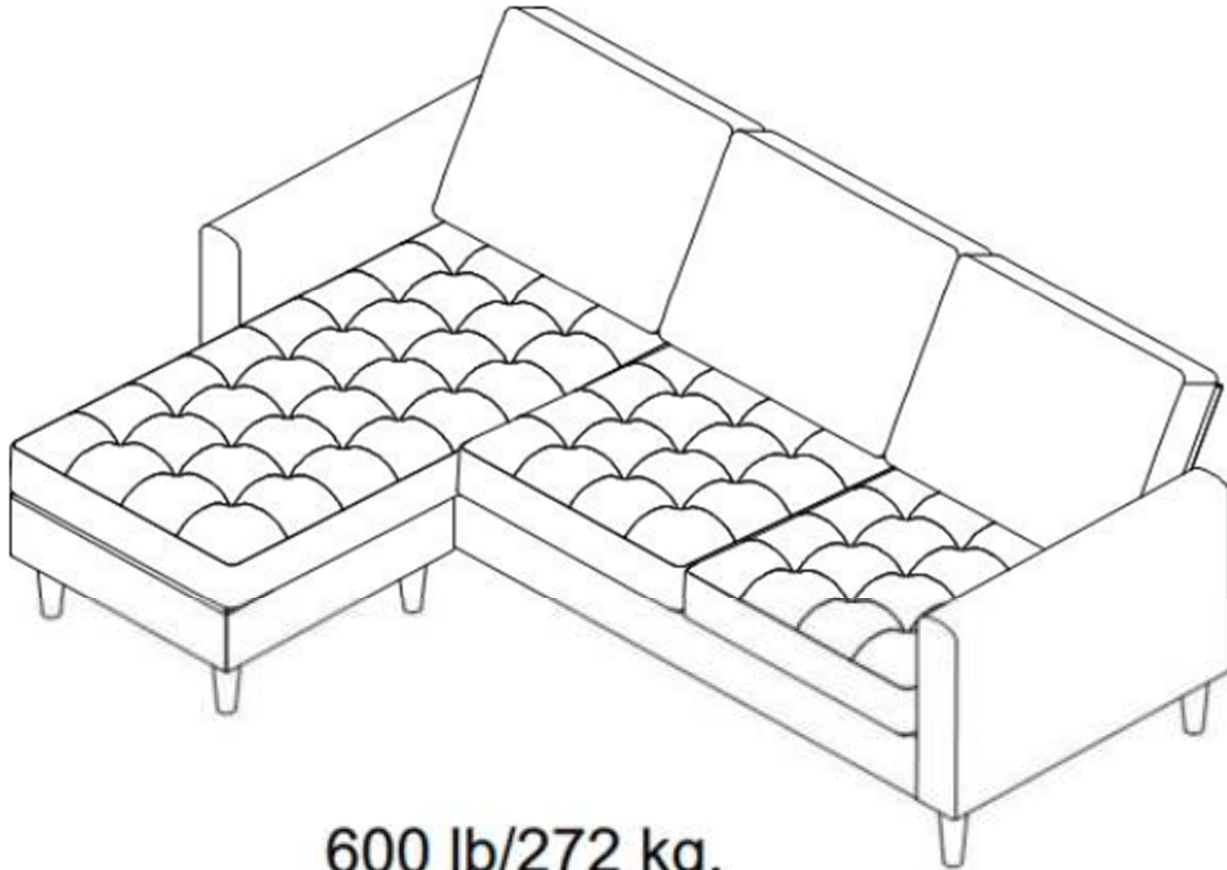

600 lb/272 kg.



|           |  |
|-----------|--|
| <b>D</b>  | Überschreiten Sie die angegebenen Maximalbelastungen nicht. Andernfalls kann das Möbelstück beschädigt oder zerstört werden.               |
| <b>GB</b> | Do not exceed the maximum loads specified. Otherwise, the furniture may sustain damage or be irreparably damaged.                          |
| <b>FR</b> | Ne dépassez pas les charges maximum indiquées. Sinon, le meuble peut être endommagé ou détruit.  |
| <b>IT</b> | Non superare il carico massimo indicato. Altrimenti il mobile rischia di rovinarsi o frantumarsi.  |
| <b>NL</b> | Overschrijd de aangegeven maximale belastingen niet. Anders kan het meubelstuk worden beschadigd of vernield.                              |
| <b>PL</b> | Nie wolno przekraczać podanych maksymalnych wartości obciążenia. W przeciwnym razie mebel może zostać uszkodzony lub zniszczony.           |
| <b>CZ</b> | Nepřekračujte uvedené maximální zatížení. V opačném případě může dojít k poškození nebo zničení nábytku.                                   |
| <b>SK</b> | Neprekročte uvedené maximálne zaťaženia. V opačnom prípade sa môže nábytok poškodiť alebo zničiť.  |
| <b>HU</b> | Tartsa be az engedélyezett maximális terhelhetőséget/teljesítményt. Különben a bútor és annak alkatrészei megsérülhetnek, tönkre mehetnek. |
| <b>RO</b> | Nu depășiți solicitările maxime specificate. Altfel puteți să deteriorați sau să distrugeți piesa de mobilier.                             |
| <b>TR</b> | Belirtilen azami yük değerini aşmayınız, aksi takdirde mobilya parçası zarar görebilir veya kullanılamaz hale gelebilir.                   |
| <b>RU</b> | Не допускается превышение указанных максимальных нагрузок. В противном случае возможно повреждение или разрушение мебели.                  |