

SORANO  
8100/2503  
2501/8300

- |           |                                                        |           |                                                     |
|-----------|--------------------------------------------------------|-----------|-----------------------------------------------------|
| <b>D</b>  | MONTAGEANLEITUNG<br>BEDIENUNGSANLEITUNG                | <b>GB</b> | ASSEMBLY INSTRUCTIONS<br>INSTRUCTION MANUAL         |
| <b>NL</b> | HANDLEIDING VOOR DE MONTAGE<br>GEBRUIKSAANWIJZING      | <b>PL</b> | INSTRUKCJA MONTAŻU<br>INSTRUKCJA OBSŁUGI            |
| <b>TR</b> | MONTAJ TALIMATI<br>KULLANIM KLAVUZU                    | <b>RU</b> | ИНСТРУКЦИЯ ПО МОНТАЖУ<br>ИНСТРУКЦИЯ ПО ЭКСПЛУАТАЦИИ |
| <b>RO</b> | INSTRUCȚIUNI DE INSTALARE<br>INSTRUCȚIUNI DE UTILIZARE | <b>IT</b> | ISTRUZIONI DI MONTAGGIO<br>MANUALE DI ISTRUZIONI    |
| <b>FR</b> | NOTICE DE MONTAGE<br>MANUEL INSTRUCTIONS               | <b>SK</b> | MONTÁŽNY NÁVOD<br>NÁVOD NA POUŽITIE                 |
| <b>HU</b> | KÖZGYŰLÉS UTASÍTÁSOK<br>KEZELÉSI UTASÍTÁS              | <b>CZ</b> | MONTÁŽNÍ NÁVOD<br>NÁVOD K POUŽITÍ                   |
| <b>SI</b> | NAVODILA ZA MONTAŽO<br>NAVODILA ZA UPORABO             | <b>PT</b> | INSTRUÇÕES DE MONTAGEM<br>MANUAL DO USUÁRIO         |
| <b>ES</b> | INSTRUCCIONES DE MONTAJE<br>MANUAL DEL USUARIO         | <b>HR</b> | UPUTE ZA MONTAŽU<br>UPUTE ZA UPOTREBU               |

**B/F**

190801

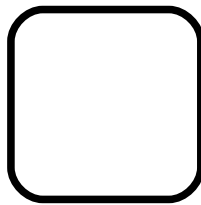
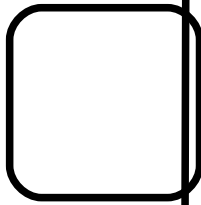

0088

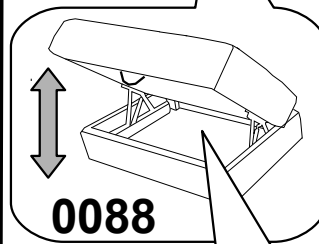
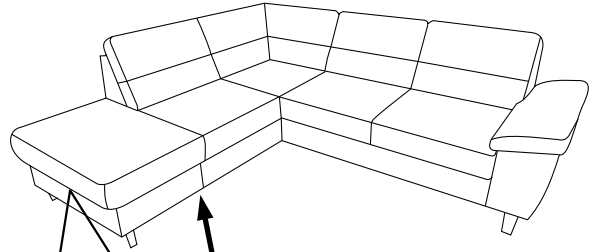
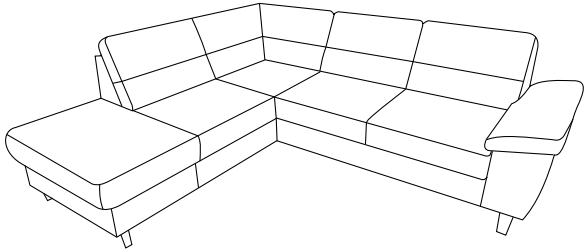
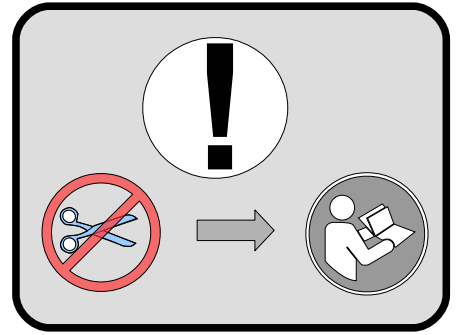

0088

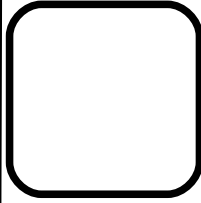
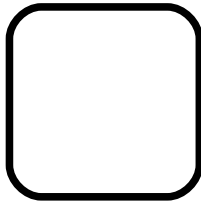
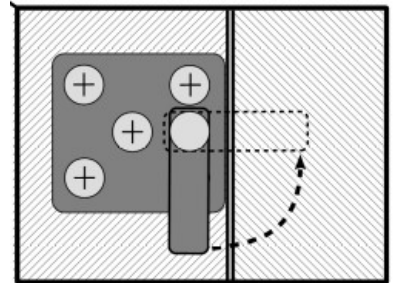

0019

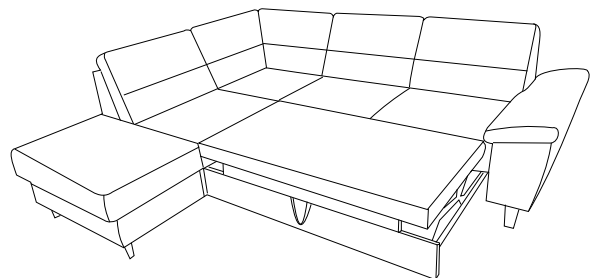
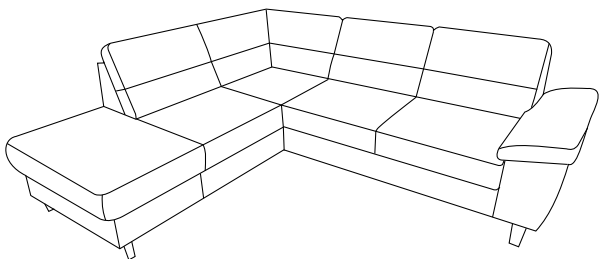

0019

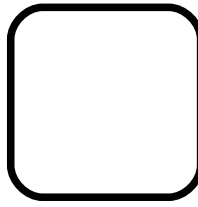
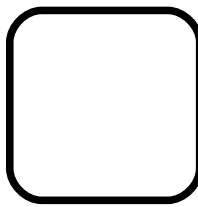



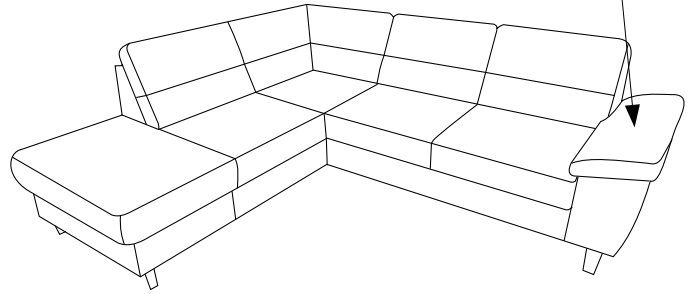
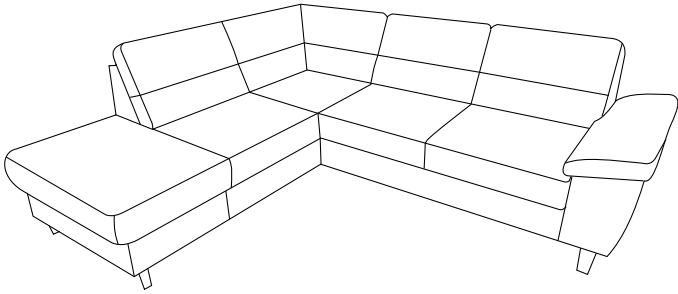
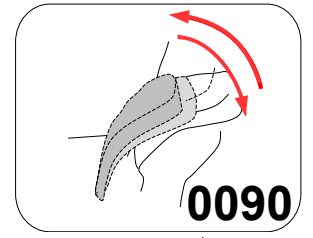



0090

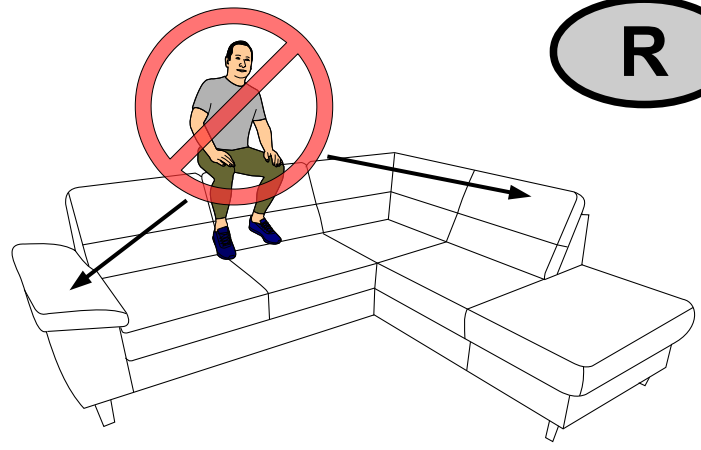
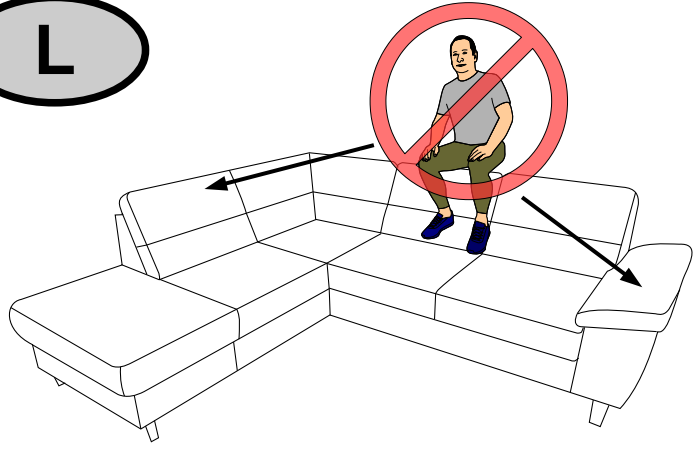





L

R

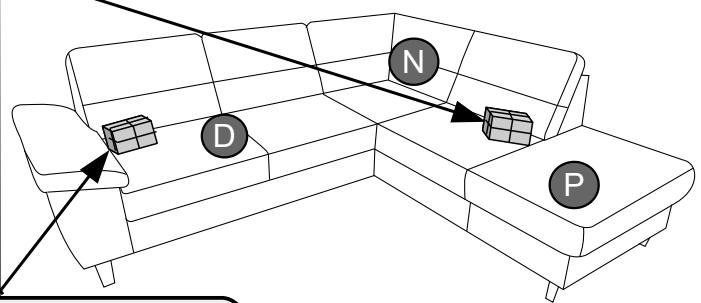
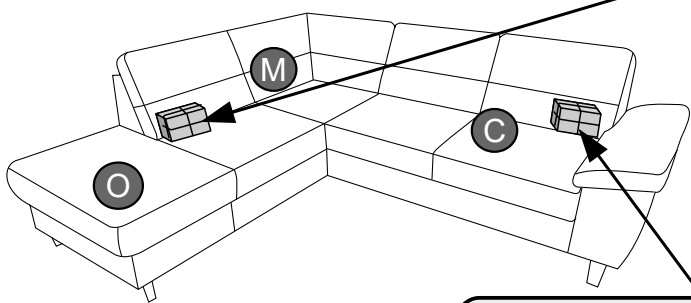

<b>g</b> H-120  X3	<b>V</b> H-120  X1	<b>i</b> L-5  X1	<b>S</b> H-120  <b>S</b> <sub>1</sub> X3	<b>q</b> M8*20 [mm]  X3
-----------------------------------------------------------------------------------------------------------	-----------------------------------------------------------------------------------------------------------	---------------------------------------------------------------------------------------------------------	-------------------------------------------------------------------------------------------------------------------------------------	------------------------------------------------------------------------------------------------------------------



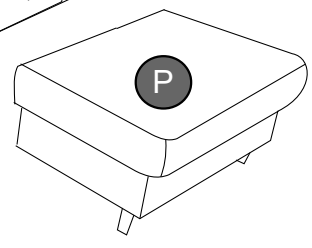
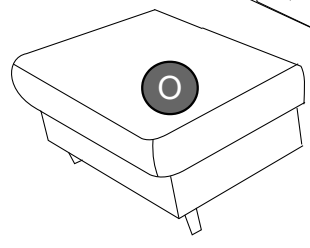
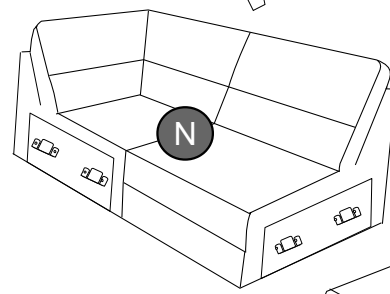
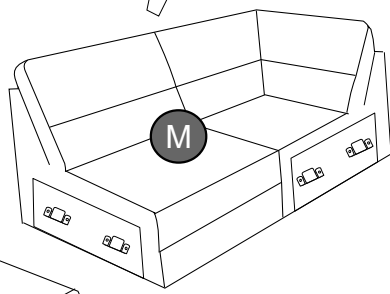
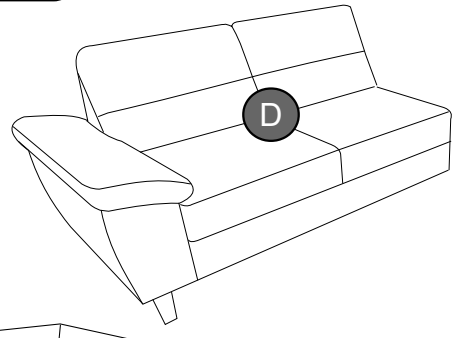
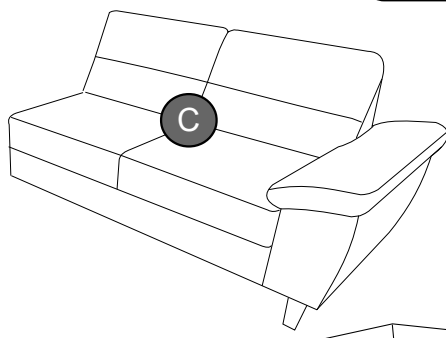

<b>i</b> L-5  X1	<b>S</b> H-120  <b>S</b> <sub>1</sub> X2	<b>q</b> M8*20  X2
-----------------------------------------------------------------------------------------------------------	--------------------------------------------------------------------------------------------------------------------------------------	--------------------------------------------------------------------------------------------------------------



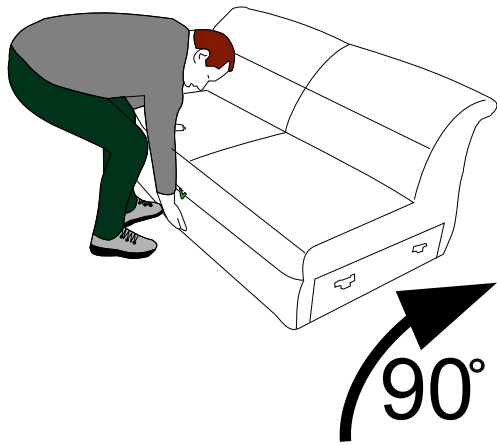

0  
10  
20  
30  
40  
50  
60  
70  
80  
90  
100  
110  
120  
130  
140  
150  
160  
170  
180  
190  
200



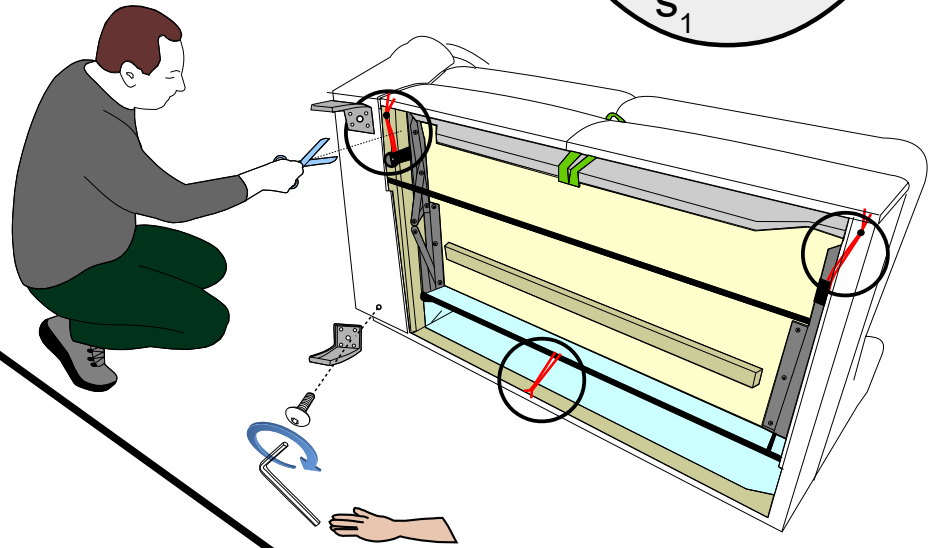
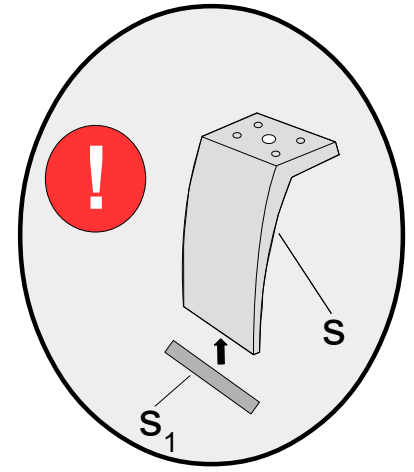



<b>i</b> L-5 	<b>S</b> H-120 	<b>q</b> M8*20 
X1	X2	X2

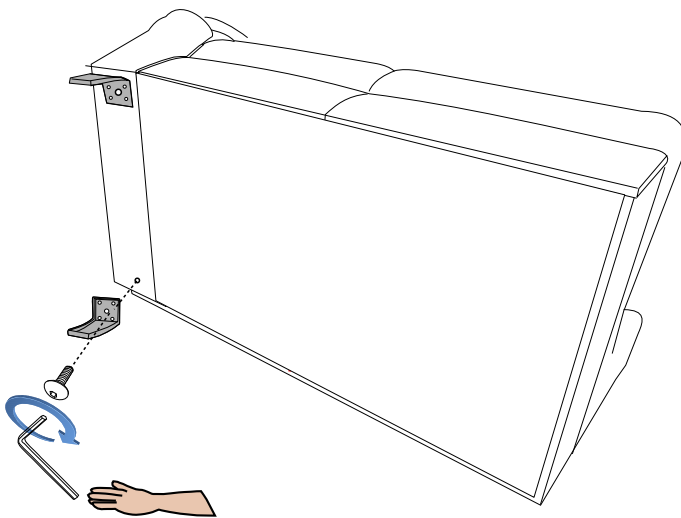

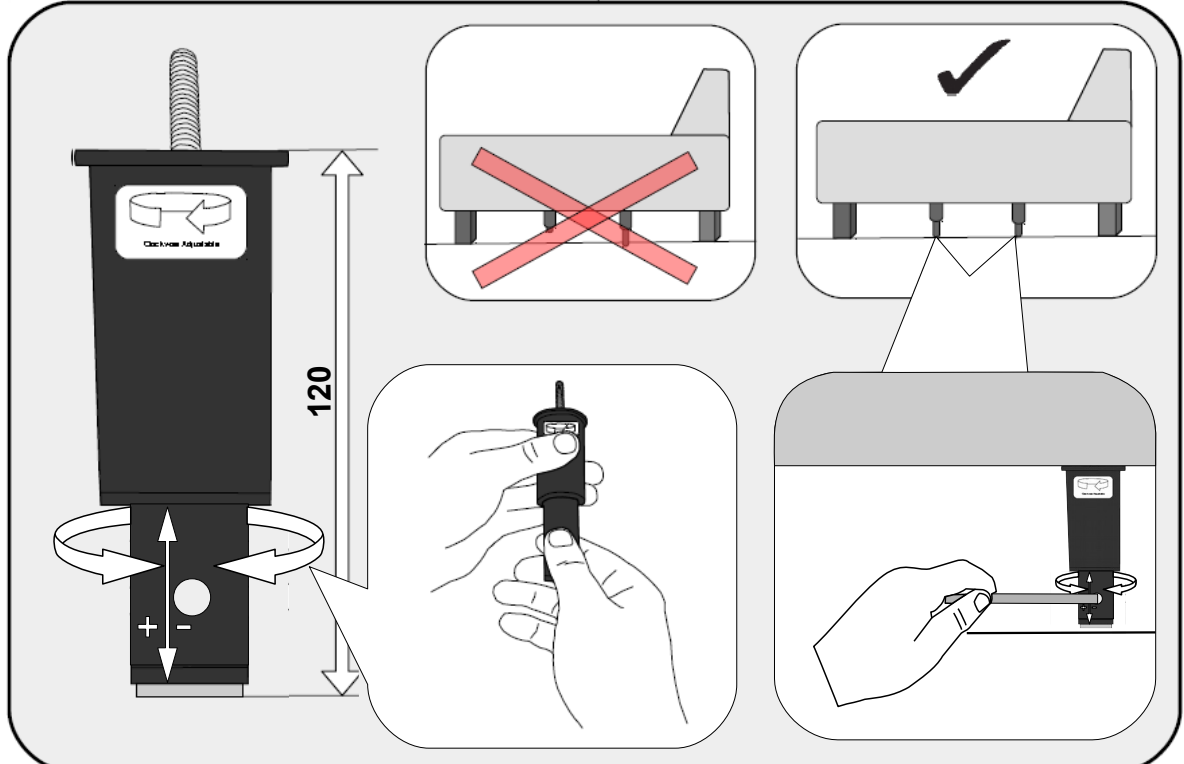
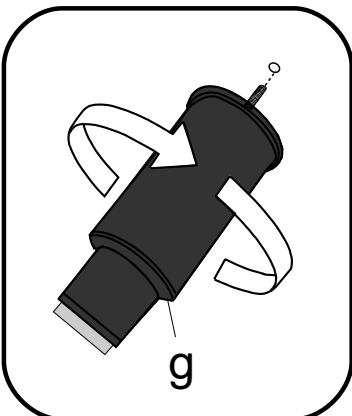
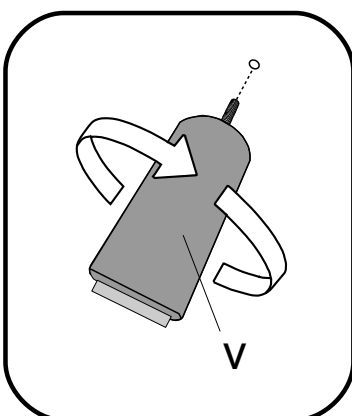
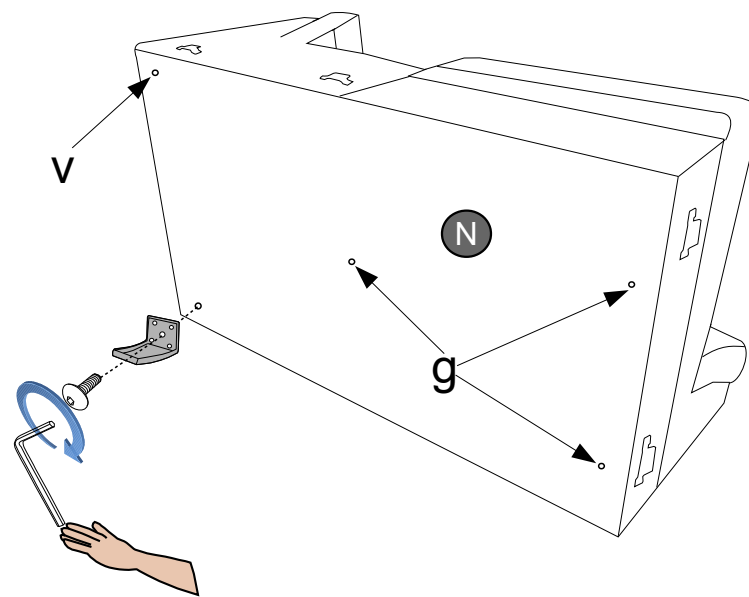
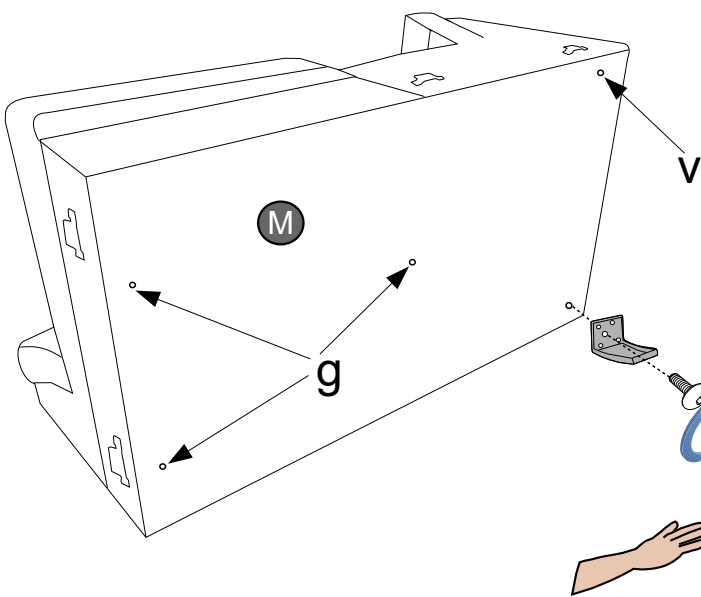
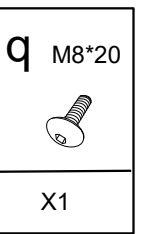
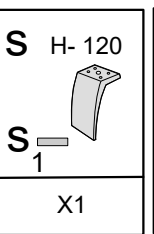
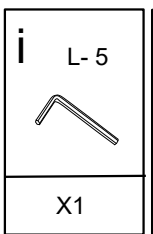
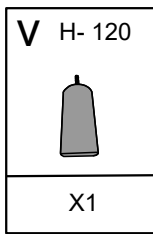
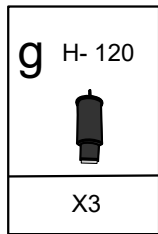
<b>i</b> L-5 	<b>S</b> H-120 	<b>q</b> M8*20 
X1	X2	X2



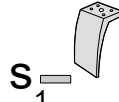

<b>i</b> L-5	<b>S</b> H-120	<b>q</b> M8*20
		
X1	X2	X2

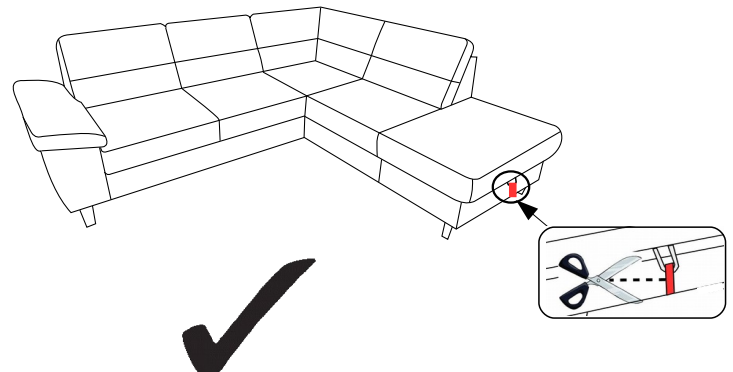
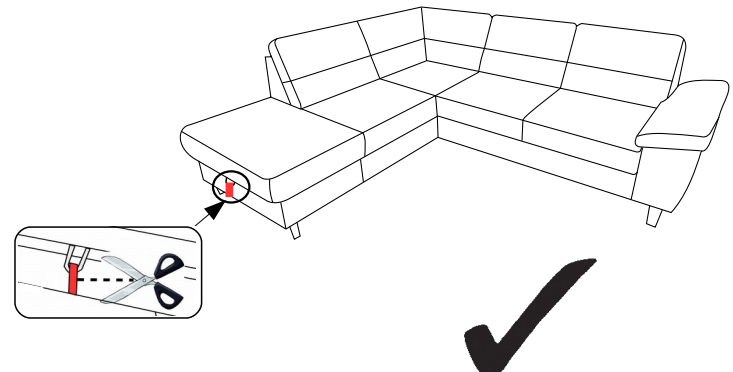
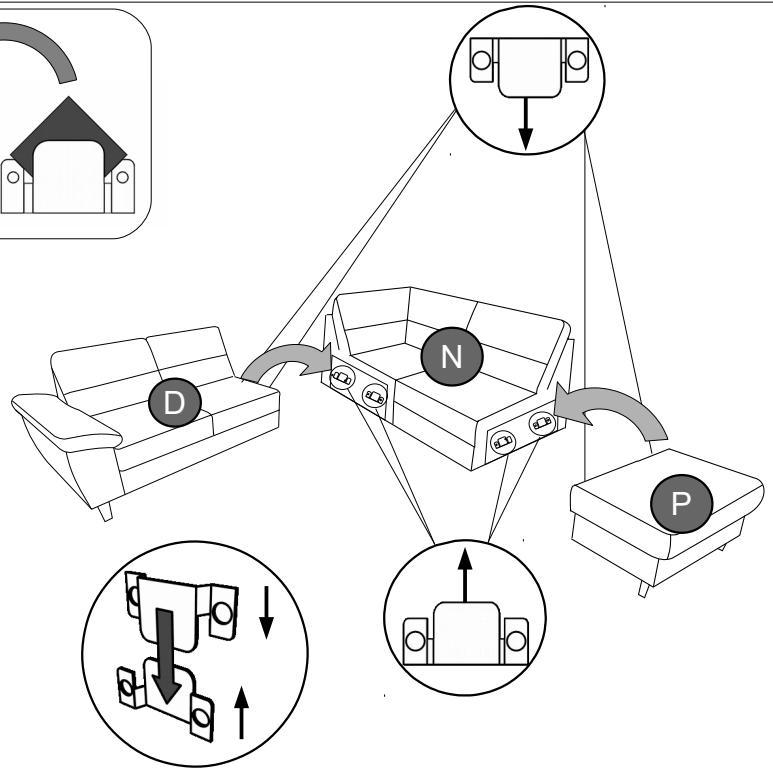
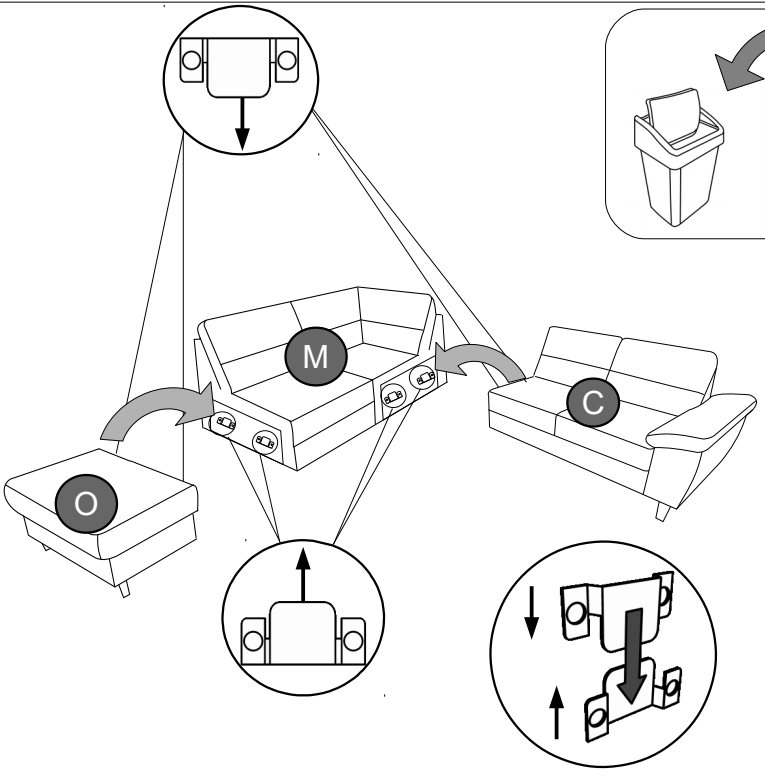
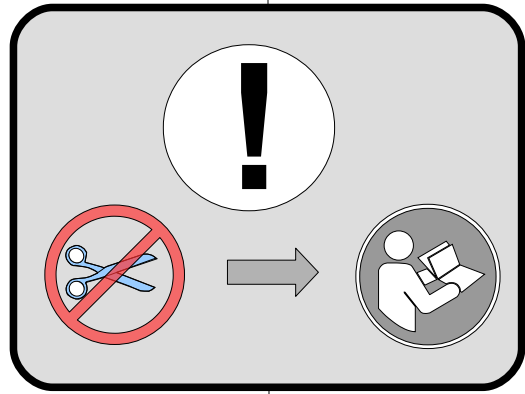
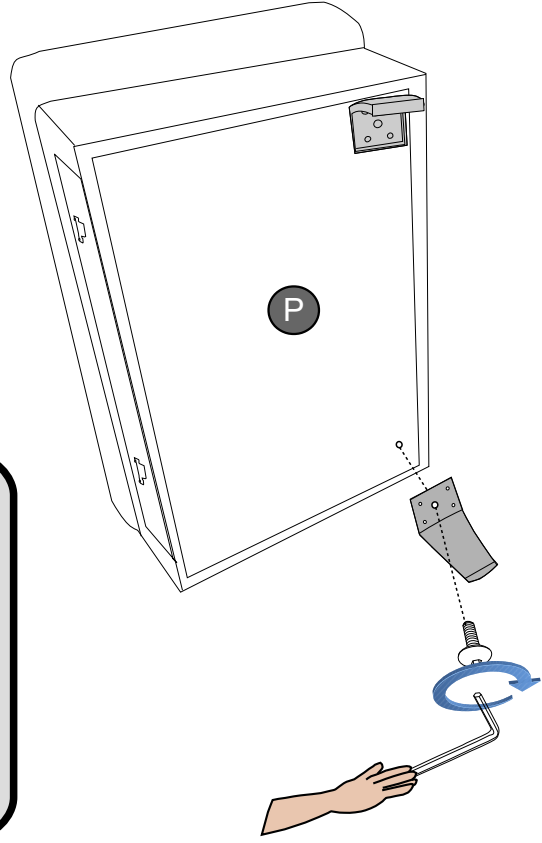
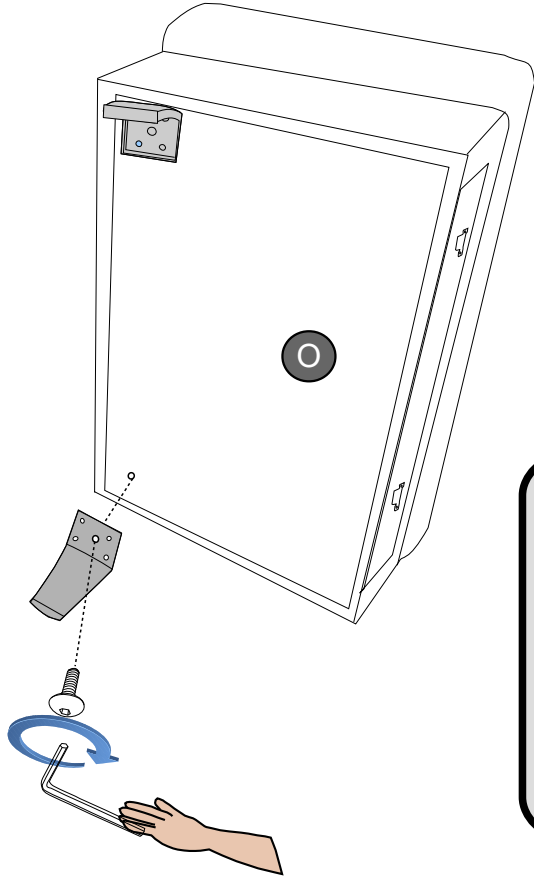

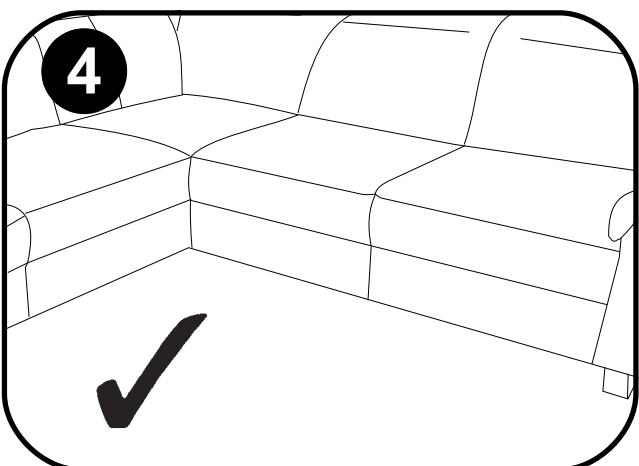
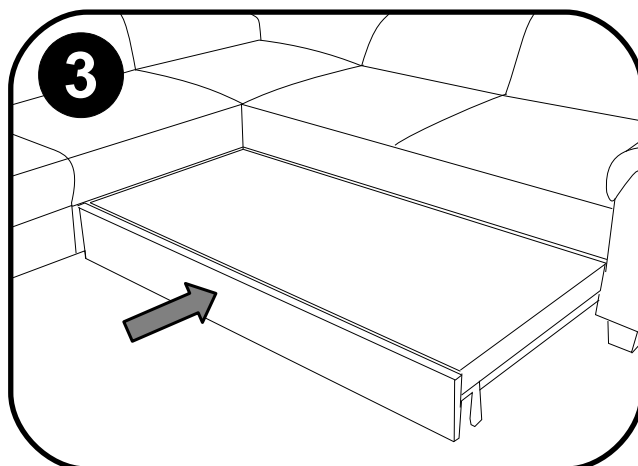
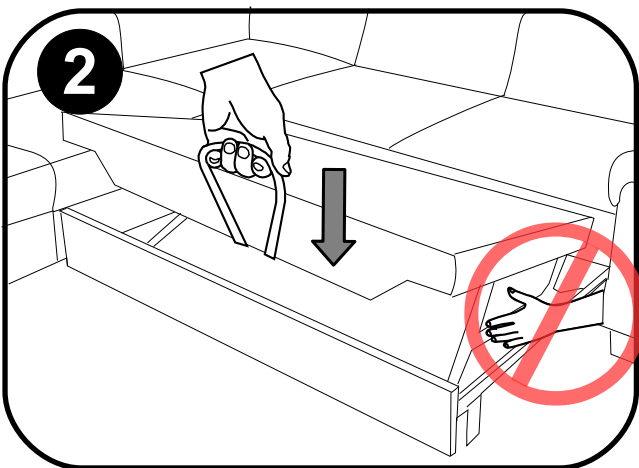
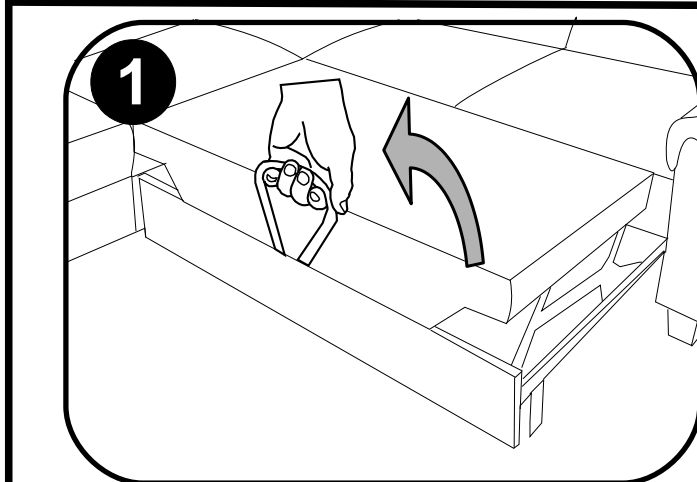
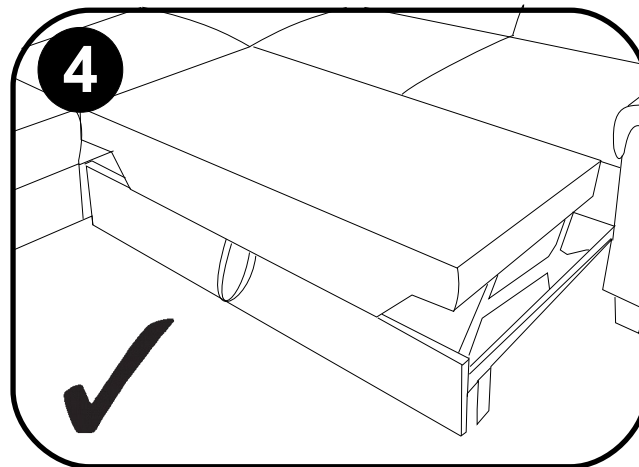
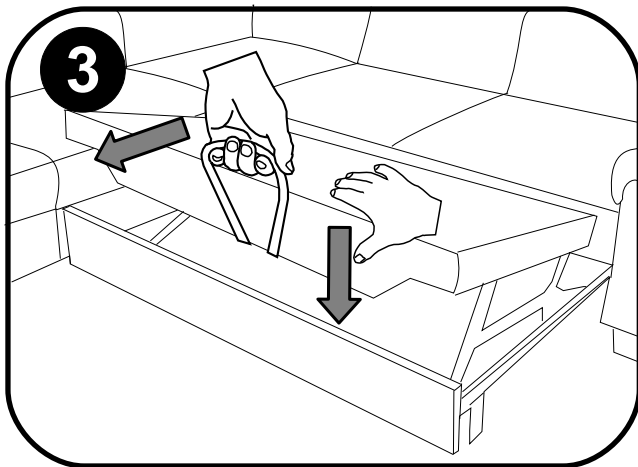
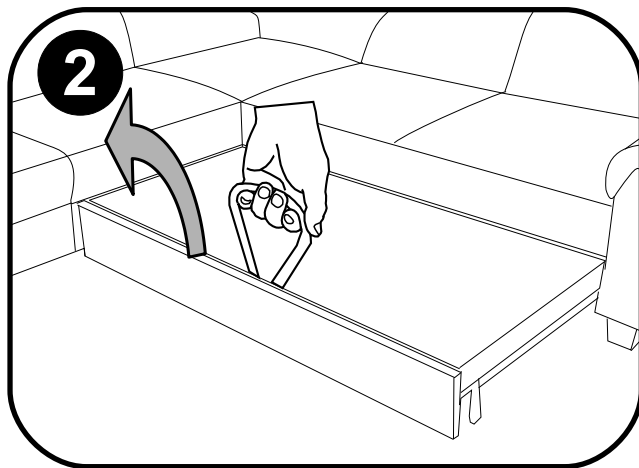
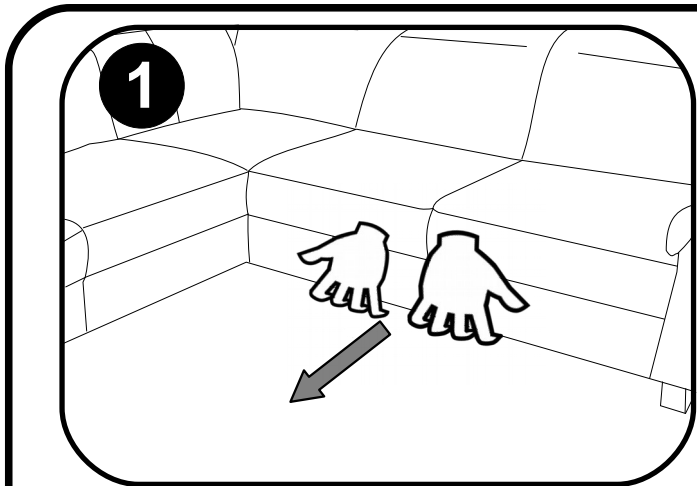
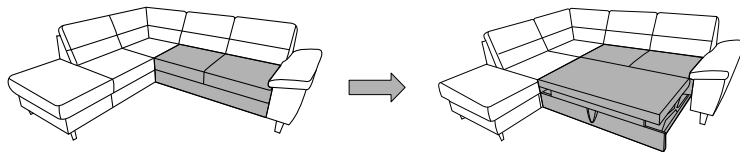



Service · Dienstverlening · Servis · Servis · Сервисная служба · Serviciu · Services · Servizio  
 ·Servisný list · Szolgáltatás · Servisní list

Name · Naam · Nazwa · Ísim · Название · Nume · Nome · Názov · Názov ·  
 Název · Neve

**SORANO**

Typ · Type · Tip · Тип · Tipo · Típus

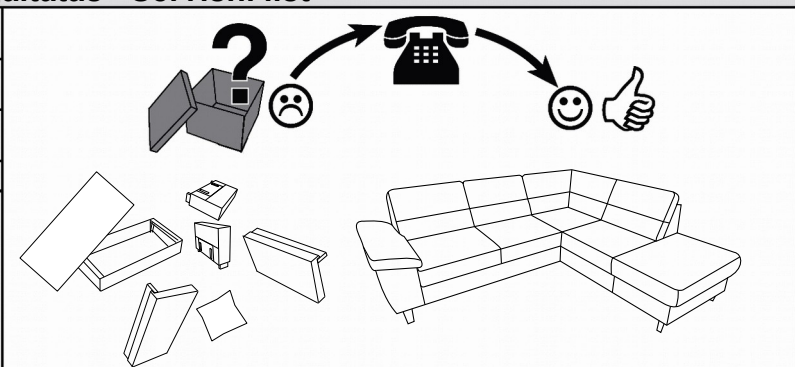
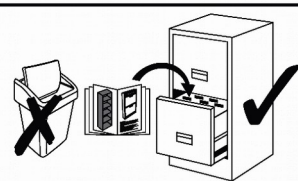
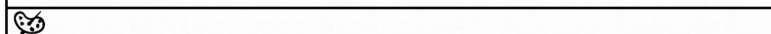

**L**

**R**

0  
10  
20  
30  
40  
50  
60  
70  
80  
90  
100  
110  
120  
130  
140  
150  
160  
170  
180  
190  
200

