

# MONTAGEANLEITUNG

SKU CODE: WF311166WAA

WF311167WAA

Dieses Set wird in 2 Kartons verschickt und kann an verschiedenen Tagen ankommen. Wenn beide Pakete angekommen sind, aber Teile fehlen, wenden Sie sich bitte an den Kundendienst.

## Etagenbett 200x90cm

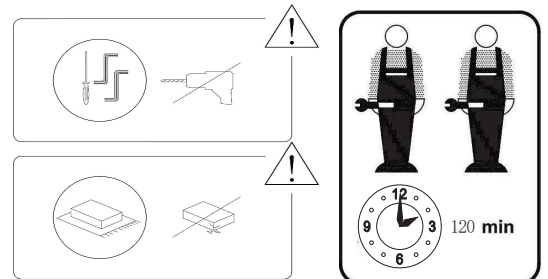
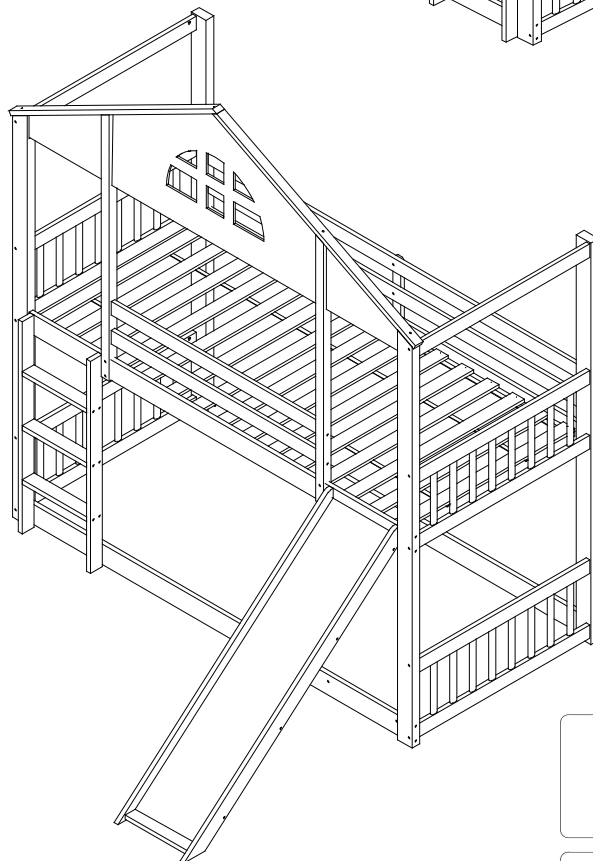
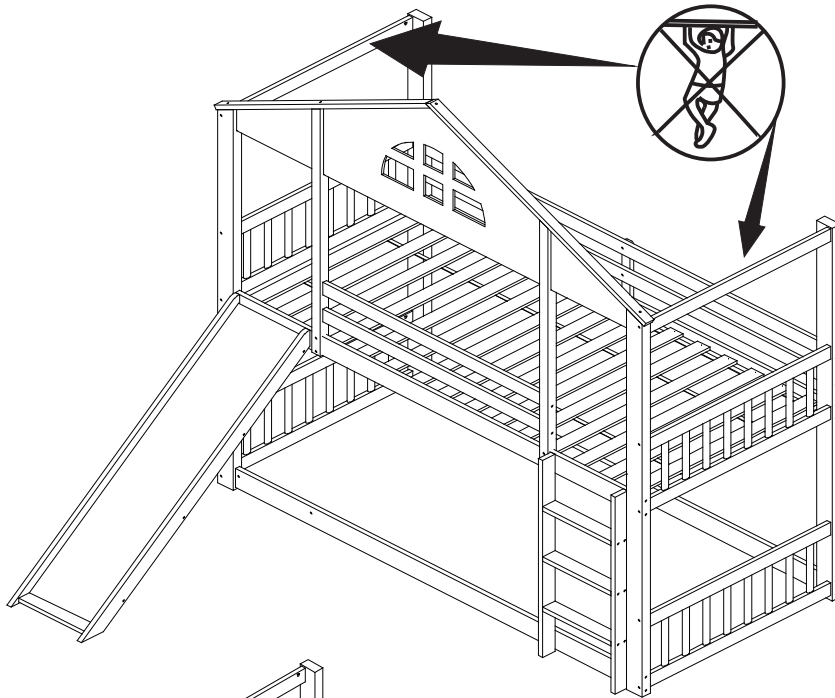

# INSTRUCTIONS

IMPORTANT-READ CAREFULLY-RETAIN FOR FUTURE REFERENCE

- a) **WARNING**-High beds and the upper bed of bunk beds are not suitable for children under six years due to the risk of injury from falls;
- b) **WARNING**-Bunk beds and high beds can present a serious risk of injury from strangulation if not used correctly. Never attach or hang items to any part of the bunk bed that are not designed to be used with the bed, for example, but not limited to ropes, strings, cords, hooks, belts and bags.
- c) **WARNING** -Children can become trapped between the bed and the wall, a roof pitch, the ceiling adjoining pieces of furniture (e.g. cupboards) and the like. To avoid risk of serious injury the distance between the top safety barrier and the adjoining structure shall not exceed 75 mm or shall be more than 230 mm.
- d) **WARNING**-Do not use the bunk bed/high bed if any structural part is broken or missing; Replacement parts are between requested from the manufacturer or the store.
- e) it is imperative to always follow the installation instructions and manufacturer's use.
- f) The recommended size of the mattress to be used with the bed is **90cmx200cm**, maximum thickness mattress: **13cm**.
- g) It is necessary to ventilate the room in order to maintain a low level moisture and prevent mold growth in the bed and its periphery.
- h) Joining devices should always be tightened properly and regularly verified. Tighten if necessary.

# ANLEITUNG







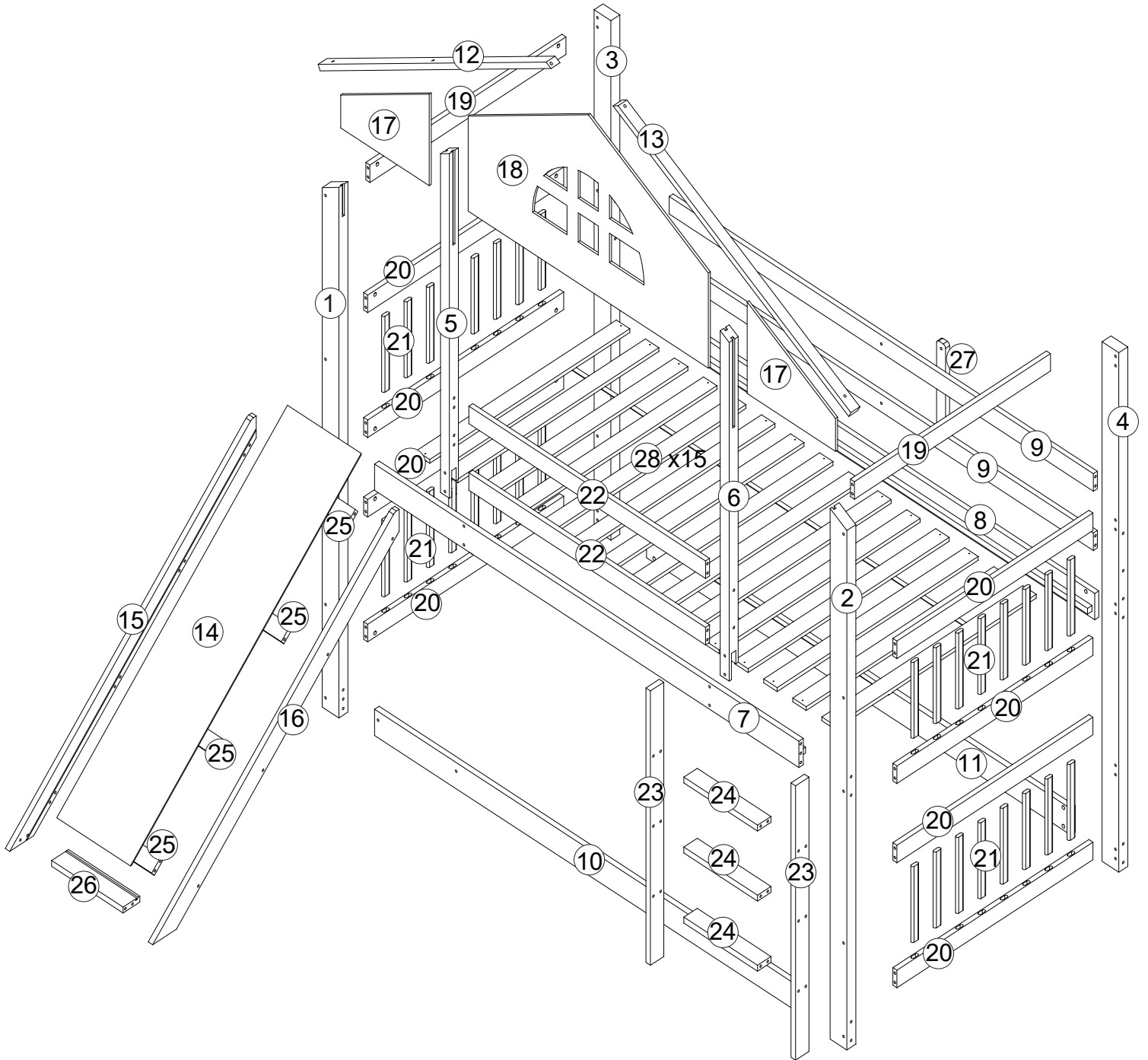



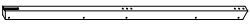
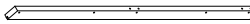
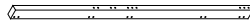
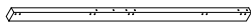
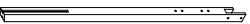
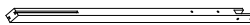



WICHTIG-SORGFÄLTIG DURCHLESEN-FÜR ZUKÜNFTIGE REFERENZ BEWAHREN

- a) **WARNUNG** -Das Oberbett von Etagenbett ist wegen der Verletzungsgefahr durch Stürze nicht für Kinder unter sechs Jahren geeignet.
- b) **WARNUNG** -Etagenbetten und Hochbetten können ein ernstes Verletzungsrisiko darstellen, wenn sie nicht ordnungsgemäß verwendet werden. Befestigen oder hängen Sie niemals etwas an einem Teil des Etagenbettes, das nicht für das Bett bestimmt ist, wie z. B. Seile, Haken, Gurte und Taschen.
- c) **WARNUNG** -Kinder können zwischen Bett und Wand eingeklemmt werden. Um die Gefahr schwerer Verletzungen zu vermeiden, darf der Abstand zwischen der oberen Sicherheitsbarriere und der angrenzenden Konstruktion 75 mm nicht überschreiten oder mehr als 230 mm betragen.
- d) **WARNUNG** -Verwenden Sie das Etagenbett/Hochbett nicht, wenn ein Bauteil beschädigt ist oder fehlt. Ersatzteile werden zwischendurch beim Hersteller oder beim Händler angefordert.
- e) Befolgen Sie unbedingt die Installationsanweisungen und die Gebrauchsanweisung des Herstellers.
- f) Die empfohlene Größe der Matratze für das Bett beträgt **90x200** cm, maximale Dicke der Matratze: **13** cm.
- g) Es ist notwendig, den Raum zu lüften, um ein niedriges Feuchtigkeitsniveau aufrechtzuerhalten und das Wachstum von Schimmel im Bett und an dessen Peripherie zu verhindern.
- h) Verbindungselemente sollten immer richtig angezogen und regelmäßig überprüft werden. Bei Bedarf festziehen.



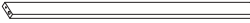

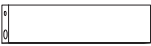
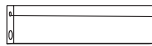

# Stückliste











## Part List WF311166WAA

① x1 	② x1 	③ x1 	④ x1 	⑤ x1 
⑥ x1 	⑦ x1 	⑧ x1 	⑨ x2 	⑩ x1 
⑪ x1 	⑫ x1 	⑬ x1 	⑭ x1 	⑮ x1 
⑯ x1 	⑰ x2 	⑱ x3 	⑳ x4 	㉑ x1 
㉒ x1 				

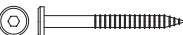
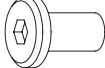
## Part List WF311167WAA

⑰ x2 	⑱ x1 	⑲ x2 	⑳ x8 	㉑ x32 
㉓ x2 	㉔ x15 			

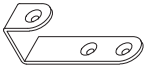
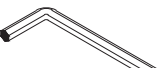
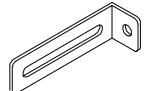
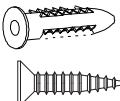
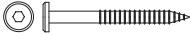
## Hardware List WF311167WAA

A x47  Φ8x30	B x24  M6x80	C x44 	D x24  Φ6x70	E x7 
F x5  M6x30	H x20  M6x120	I x12  Φ4x15	J x32  Φ4x30	K x4 
M x1 	N x2 	O x2 	P x5  Φ6x50	Q x2  M6x20

### Step 1

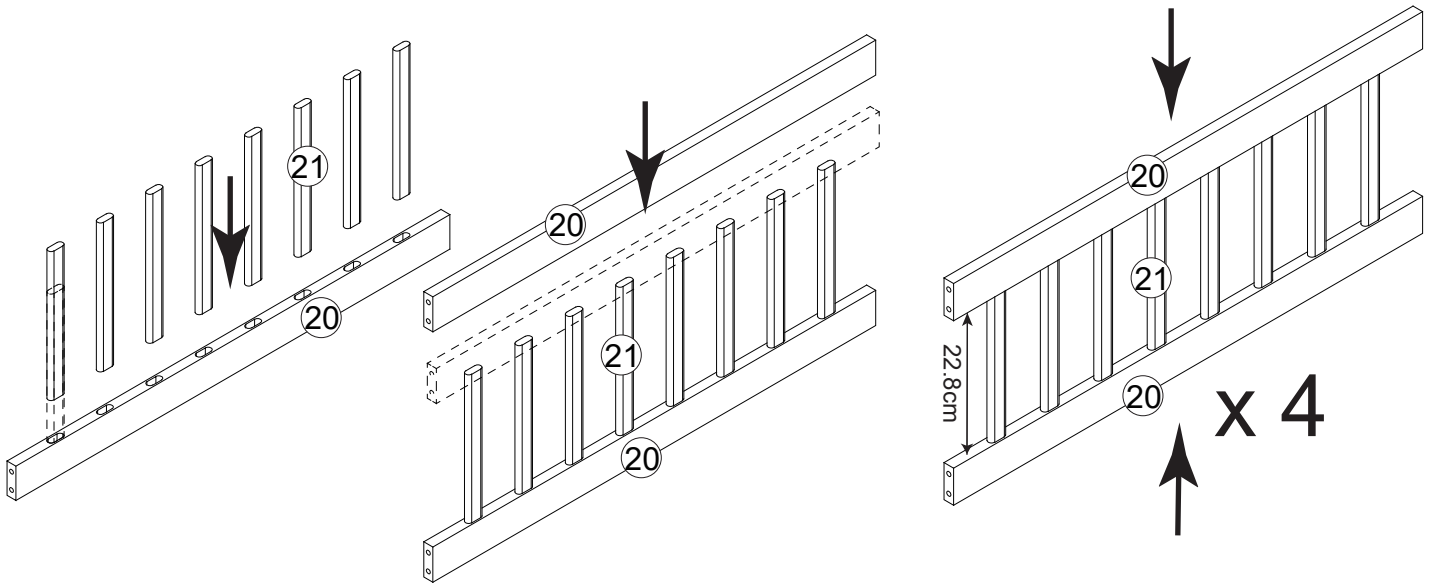

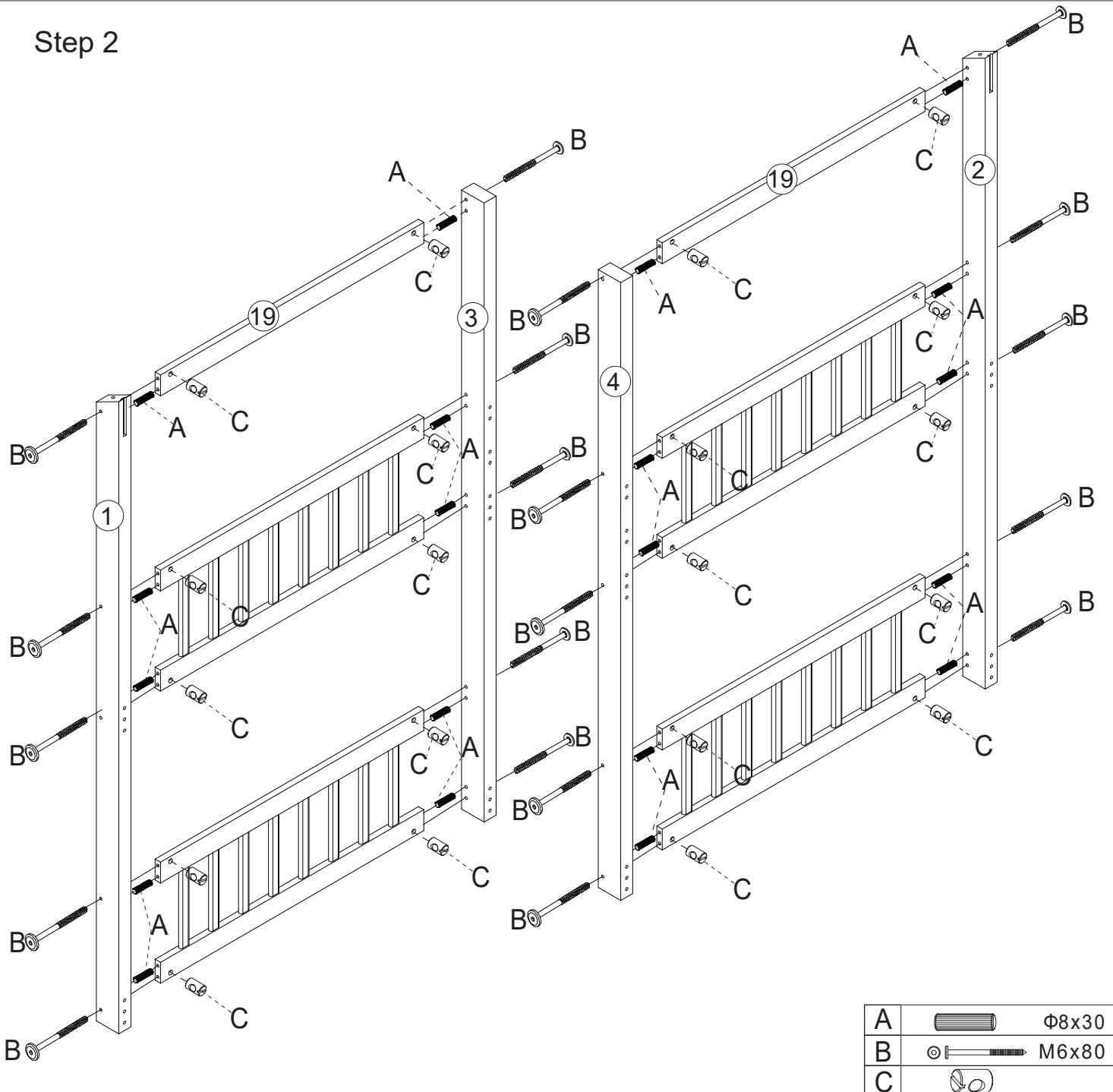

### Step 2





A		Φ8x30	20
B		M6x80	20
C			20

# Step 3

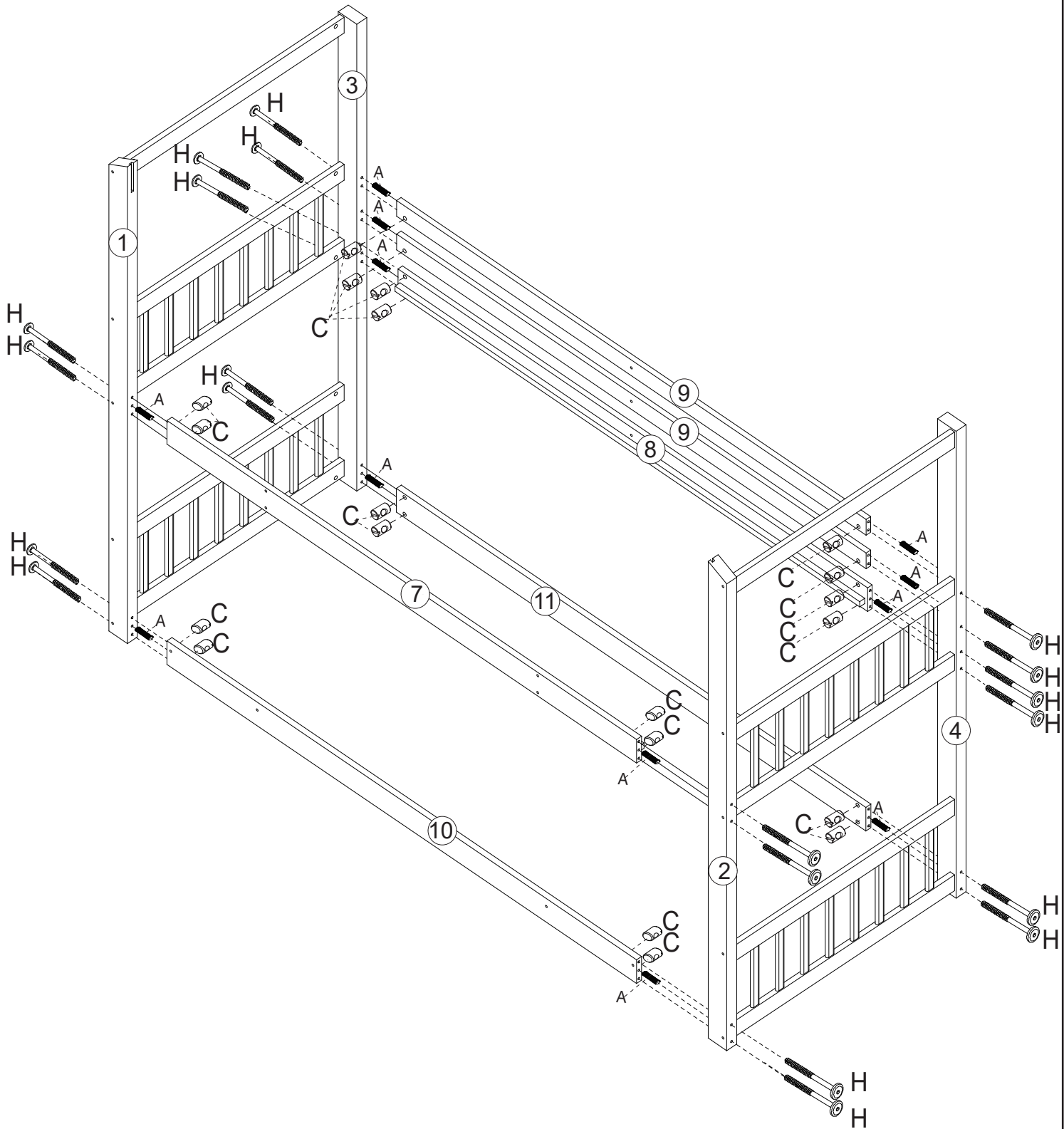
A		Φ8x30	12
H		M6x120	20
C			20

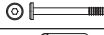

# Step 4

A		Φ8x30	4
B		M6x80	4
C			4

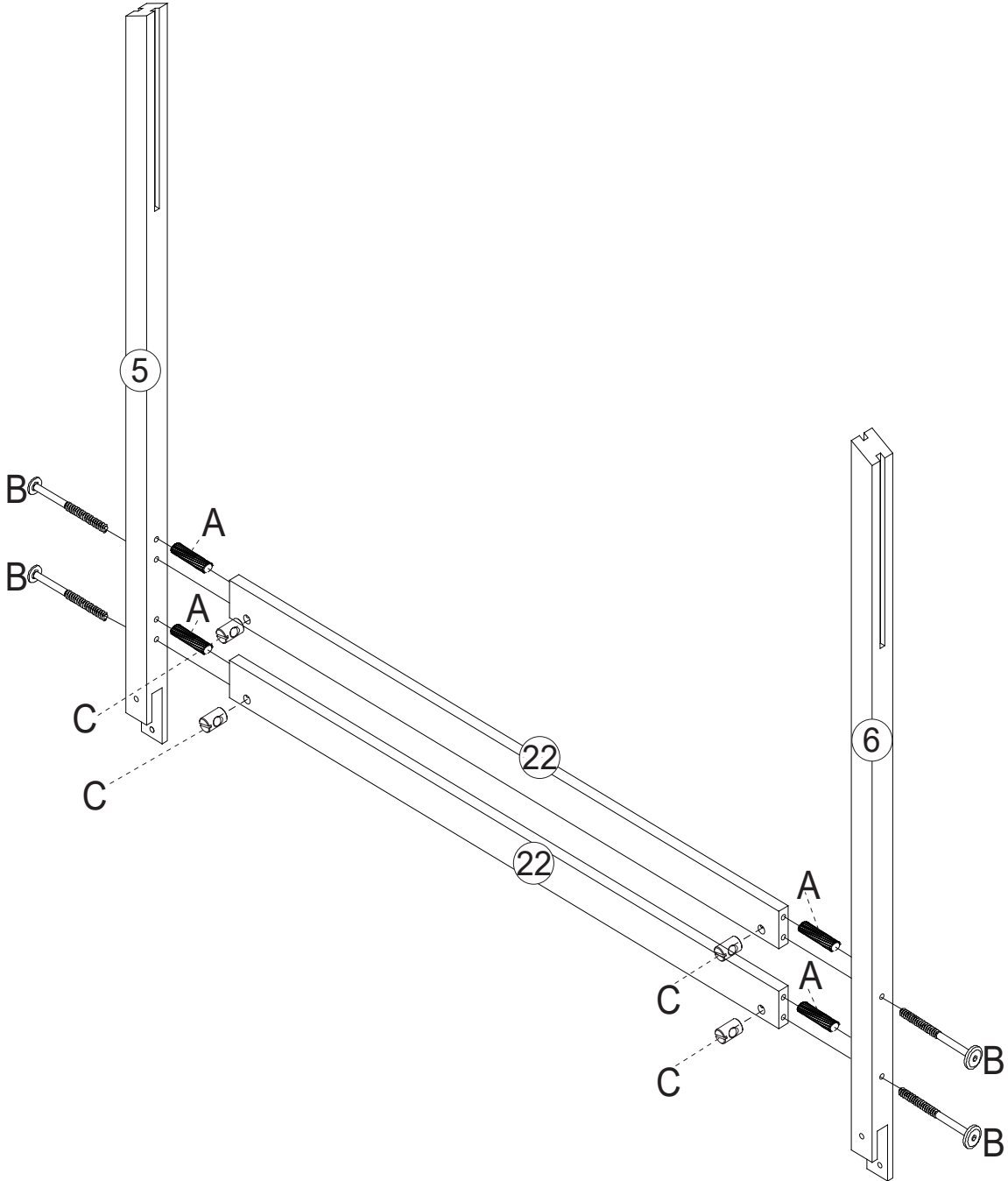

# Step 5

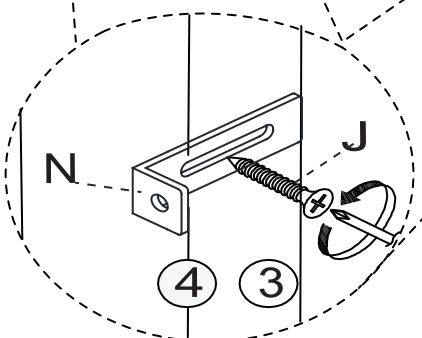
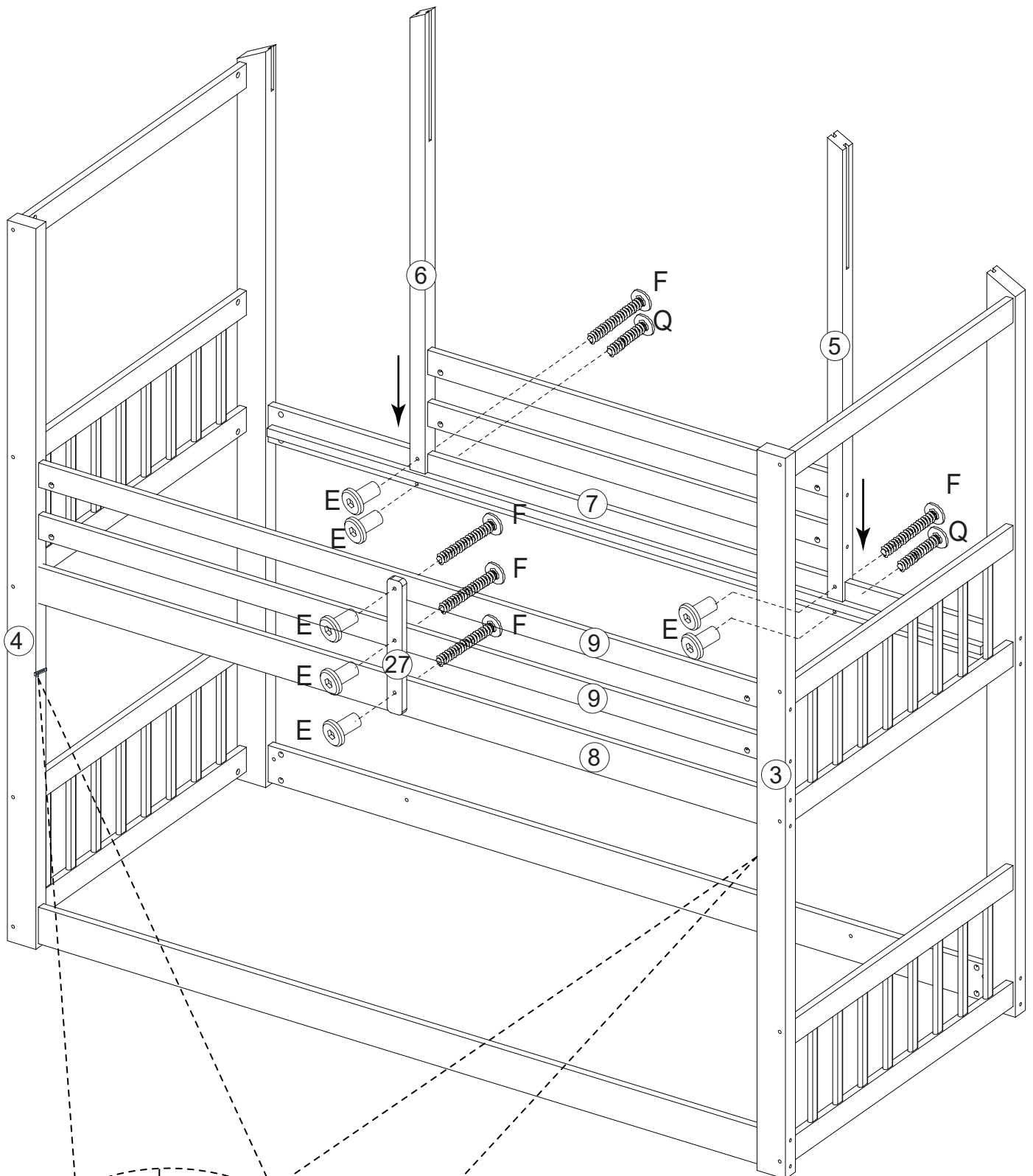

N			2
J		M4x30	2
F		M6x30	7
E			7
Q		M6x20	2



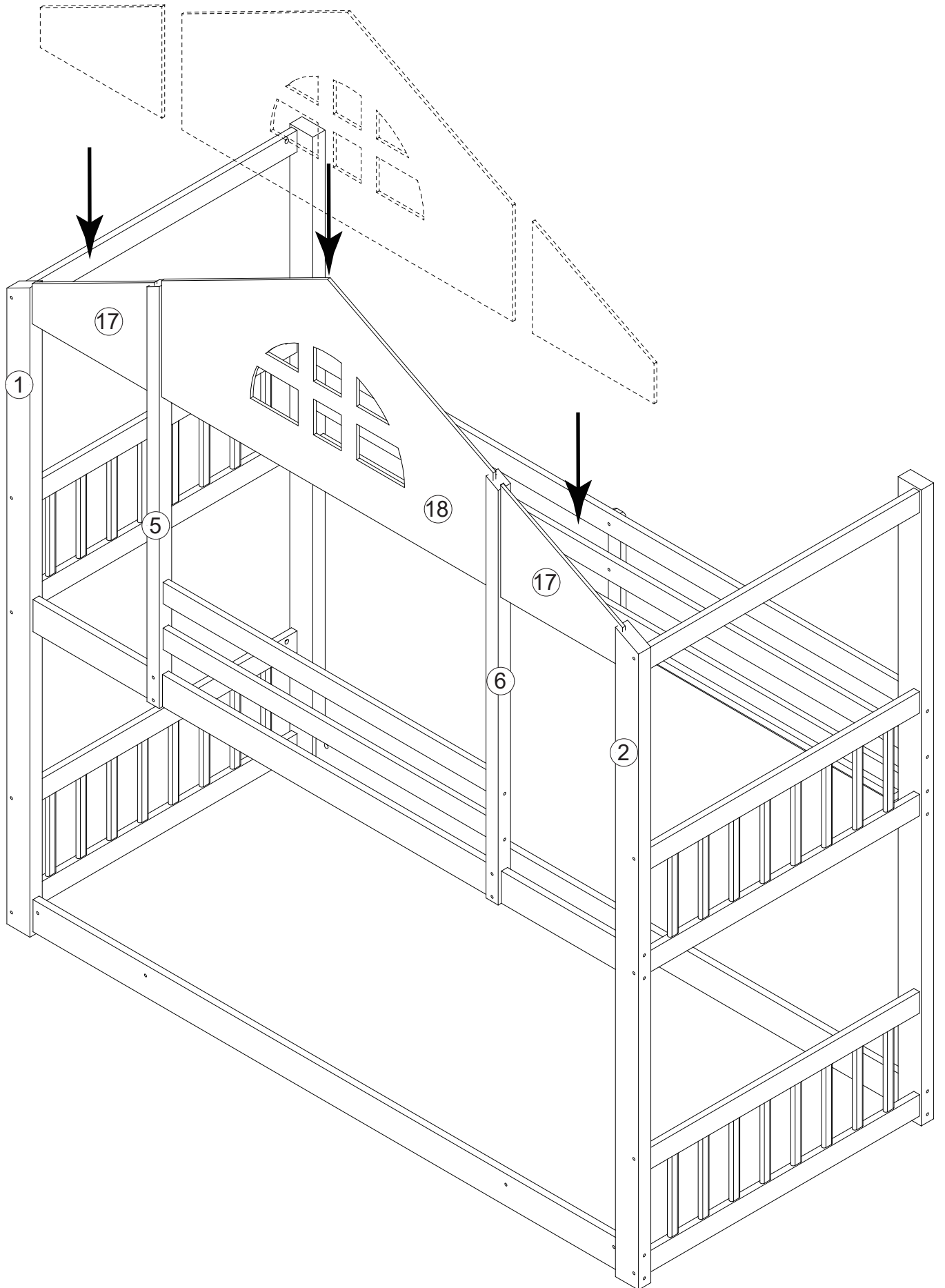

Step 6

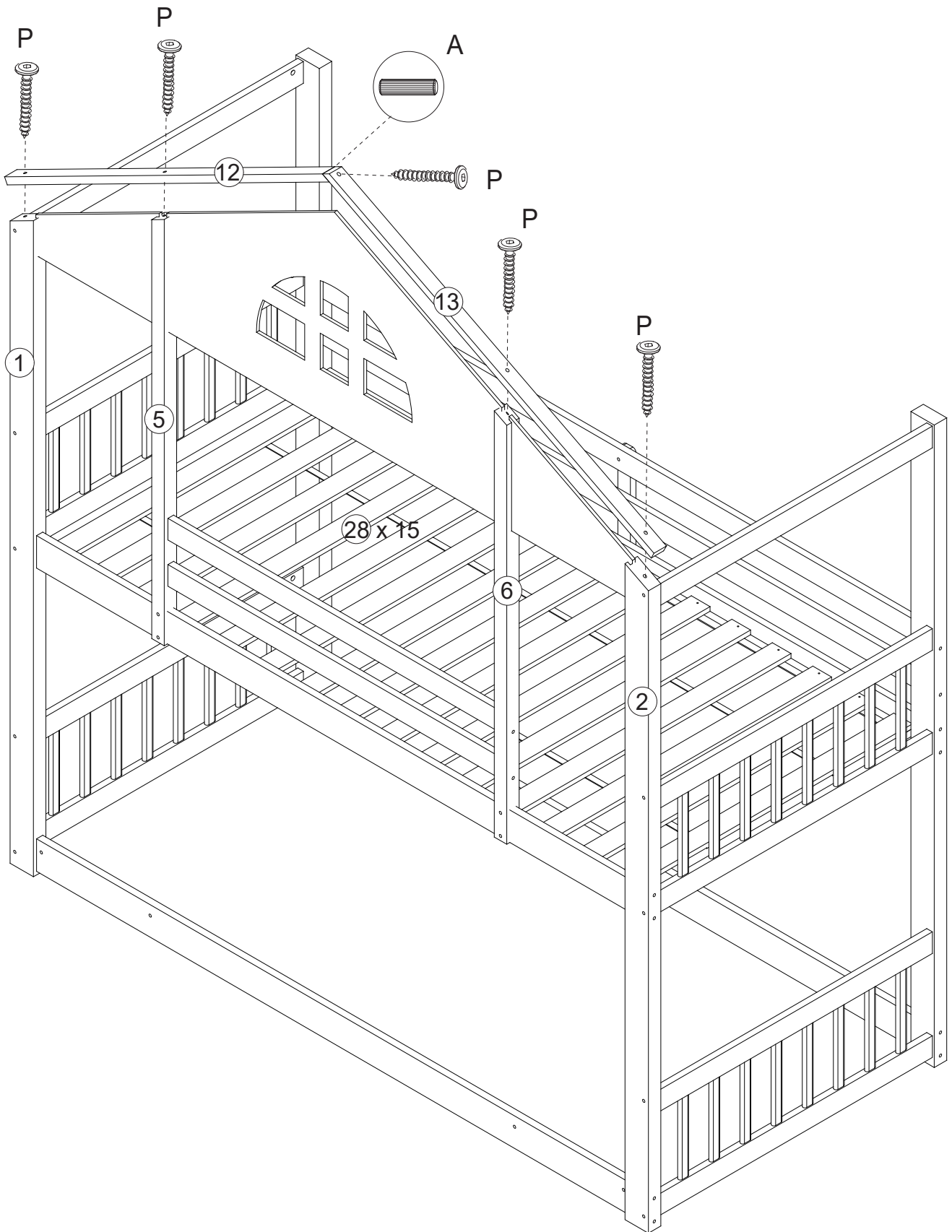

# Step 7





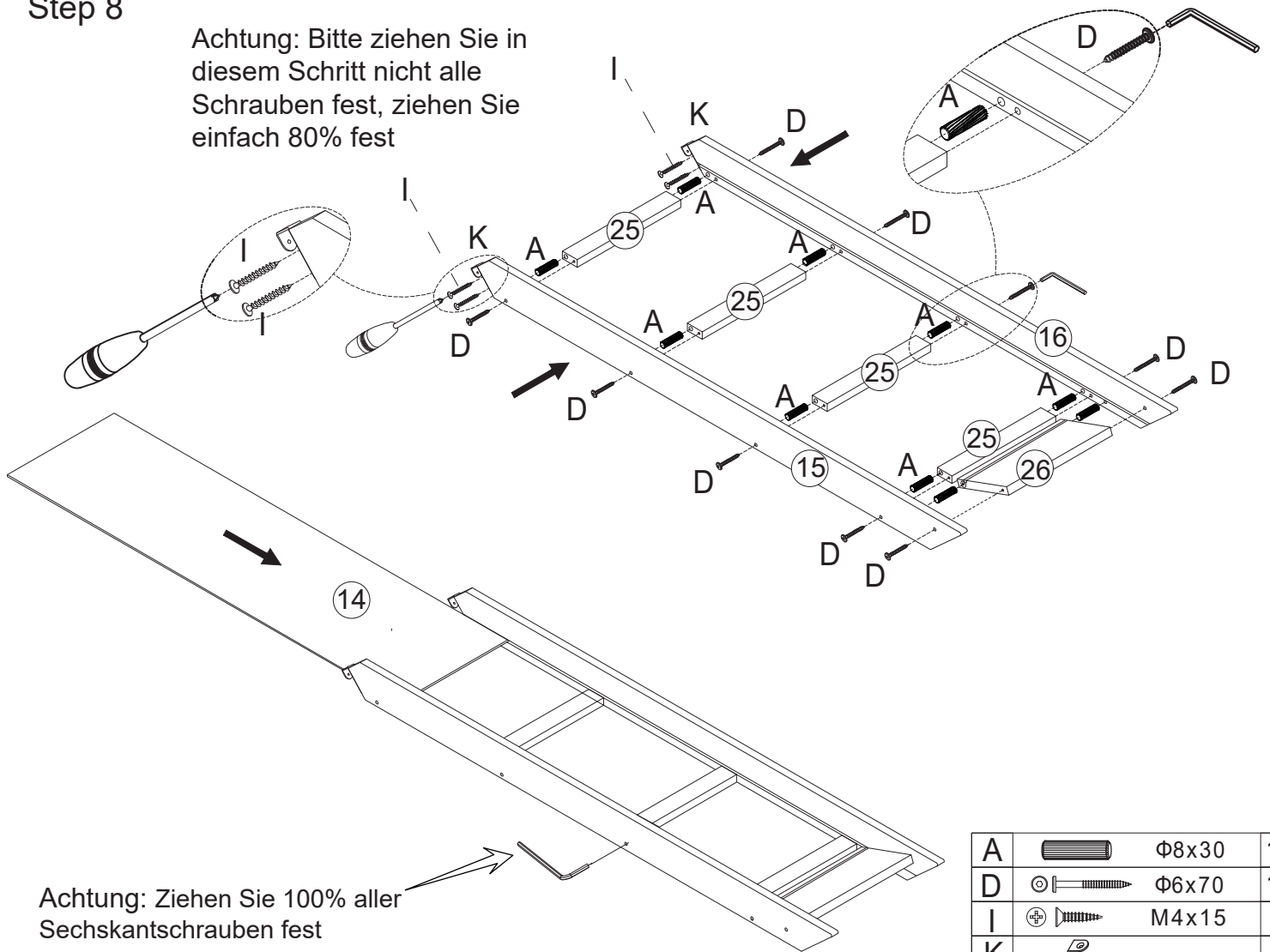

A		Φ8x30	1
P		Φ6x50	5

## Step 8

Achtung: Bitte ziehen Sie in diesem Schritt nicht alle Schrauben fest, ziehen Sie einfach 80% fest





Achtung: Ziehen Sie 100% aller Sechskantschrauben fest



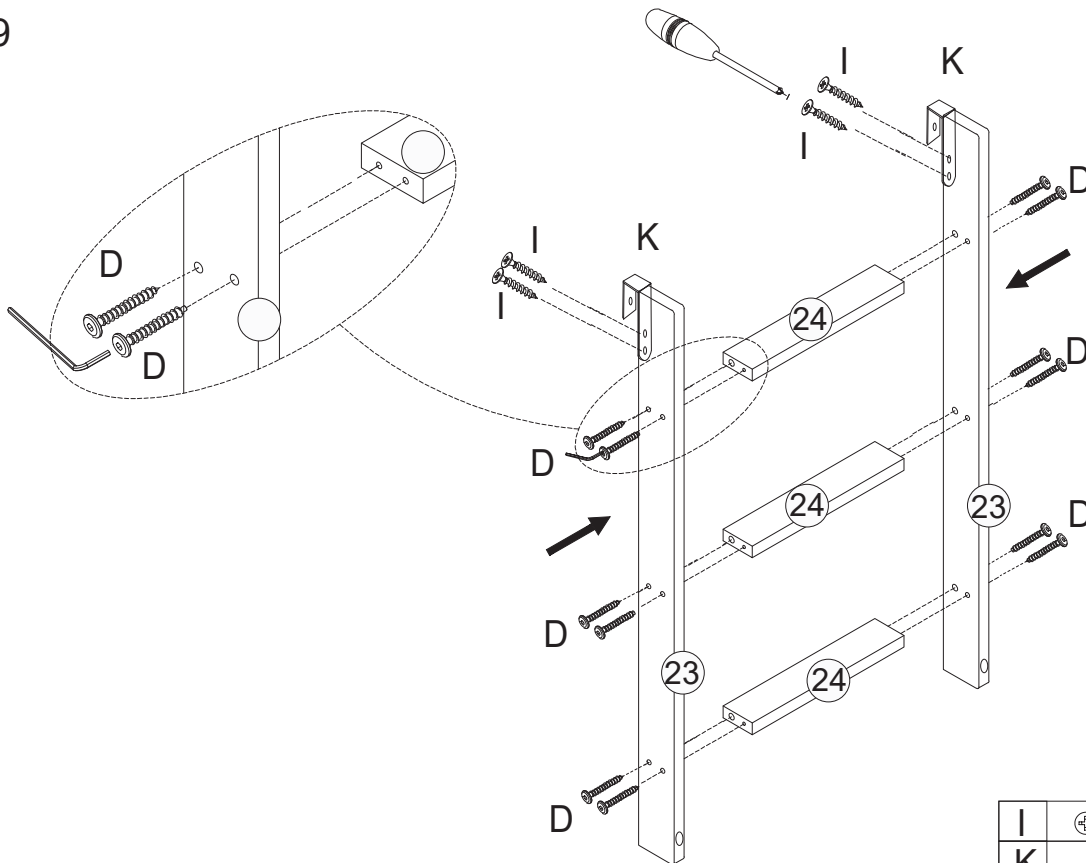

A		Φ8x30	10
D		Φ6x70	10
I		M4x15	4
K			2

## Step 9



I		M4x15	4
K			2
D		Φ6x70	12

# Step 10

O			2
I		M4x15	4
D		Φ6x70	2

WALL



**Etagenbett:  
muss an der Wand  
befestigt werden**

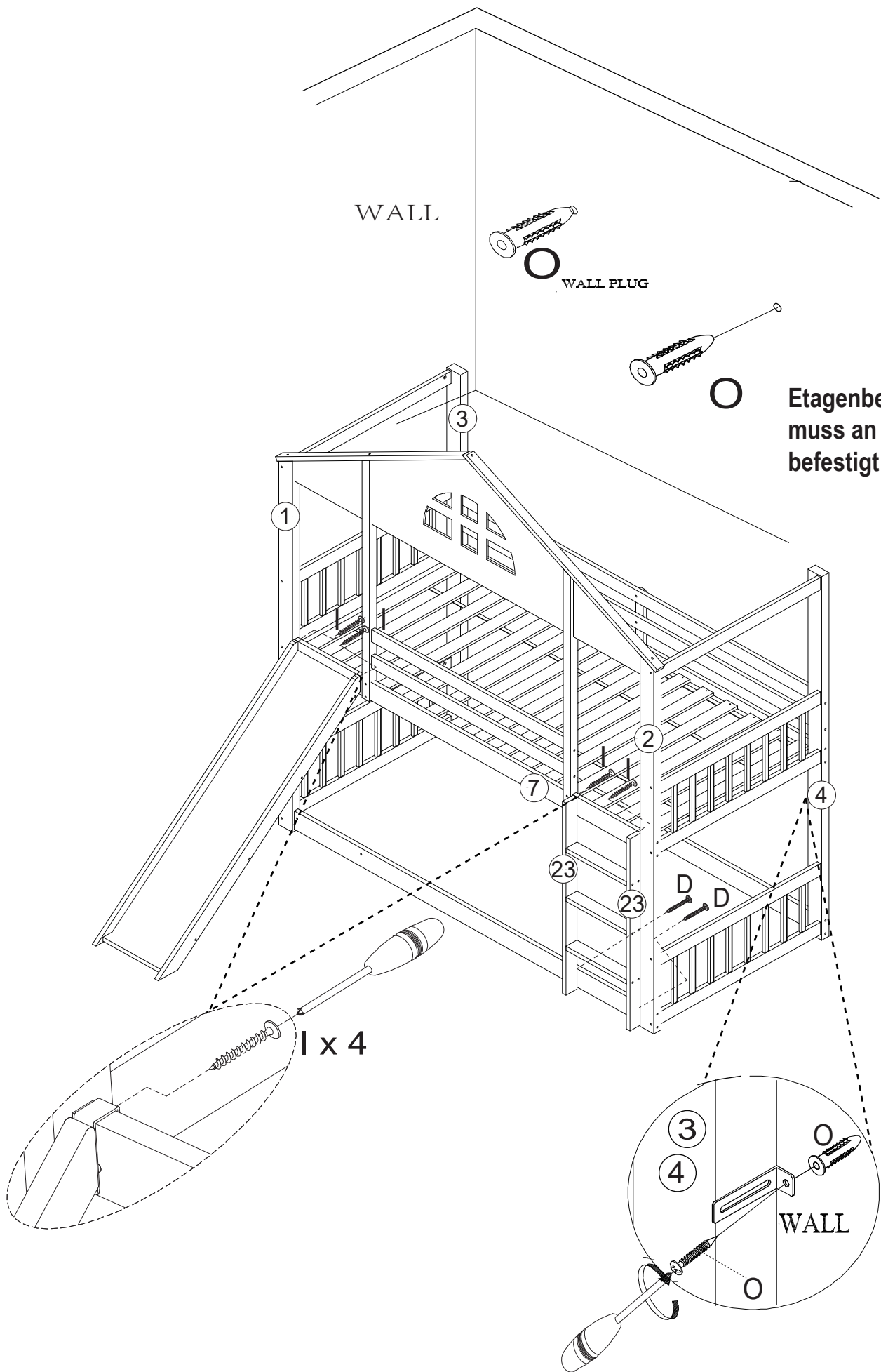

I x 4

Step 11

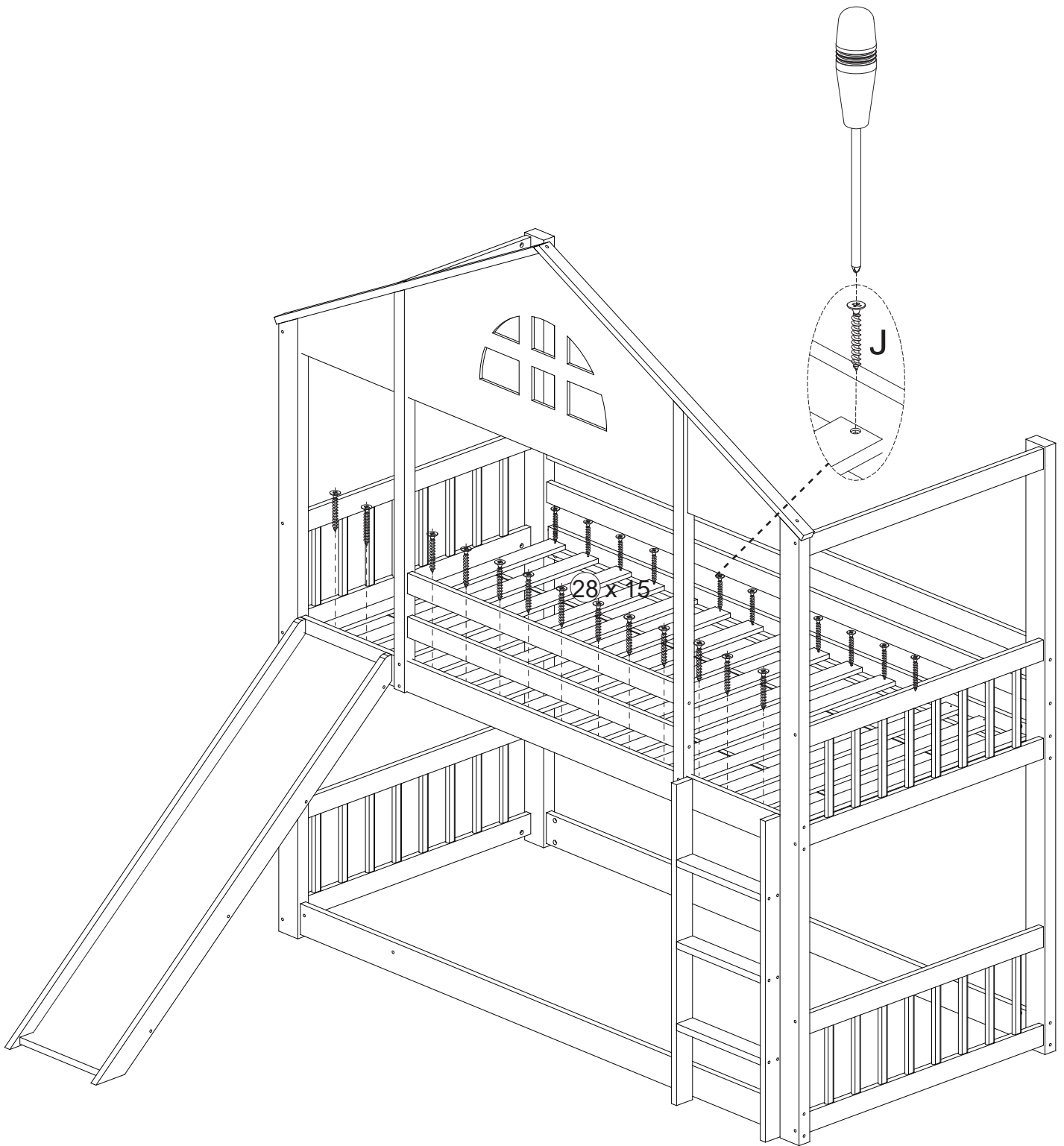

Step 12

