

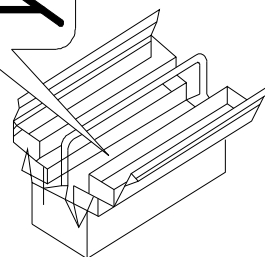

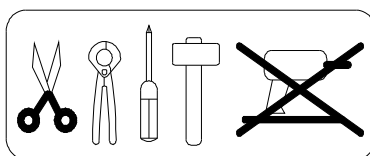

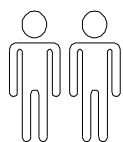

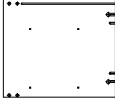
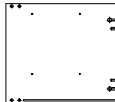

- |                                       |                                   |
|---------------------------------------|-----------------------------------|
| <b>D</b> Montageanleitung             | <b>GB</b> Assembly instructions   |
| <b>NL</b> Handleiding voor de montage | <b>PL</b> Instrukcja montazu      |
| <b>TR</b> Montaj talimati             | <b>RU</b> Инструкция по монтажу   |
| <b>FR</b> Notice de montage           | <b>IT</b> Istruzioni di montaggio |
| <b>CS</b> Montážní návod              | <b>SK</b> Návod na montáž         |
| <b>HU</b> Szerelési útmutató          | <b>RO</b> Instrucțiuni de montaj  |

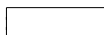

# SC865NAR

ITEM NO.	MEASUREMENT	QTY	SHAPE	CARTON NO.
①	445 X 376 X 15	X1		1-1
②	445 X 376 X 15	x1		1-1
③	430 X 76 X 15	x2		1-1
④	470 X 394 X 25	x1		1-1
⑤	383 X 344 X 5	x2		1-1
⑥	460 X 190 X 15	x2		1-1
⑦	350 X 118 X 15	x2		1-1
⑧	350 X 118 X 15	x2		1-1
⑨	374 X 118 X 15	x2		1-1
⑩	439 X 378 X 5	x1		1-1
⑪	68 X 68 X 25	x2		1-1

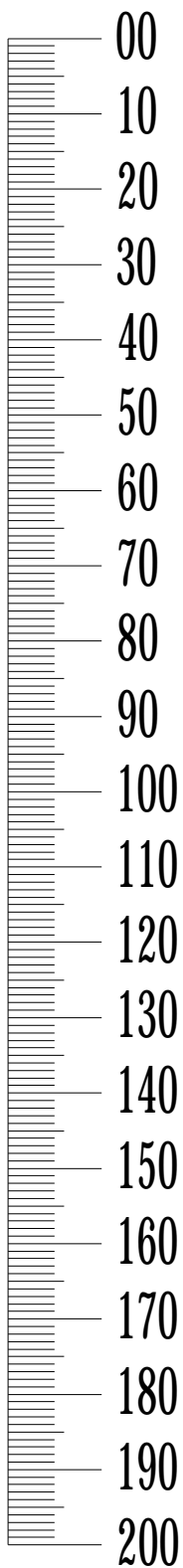

Service • Asistenza • Dienstverlening • Serwis Servis • Szerviz • Сервисная служба	
Name • Nom • Nome • Naam • Nazwa • Jméno • Názov • Név • Denumire • Isim • Название	
Nr. • No. • N° • Номер • Číslo • Sz	
Тур • Type • Típus • Tipus • Típo • Тип	

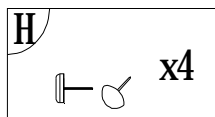
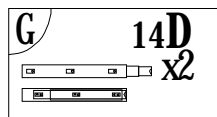
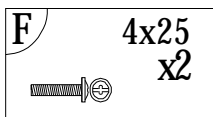
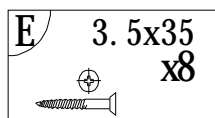
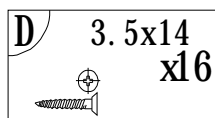
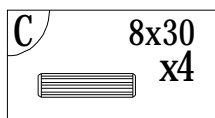
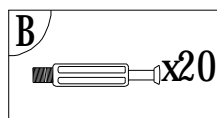
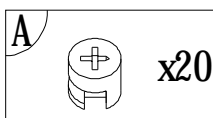
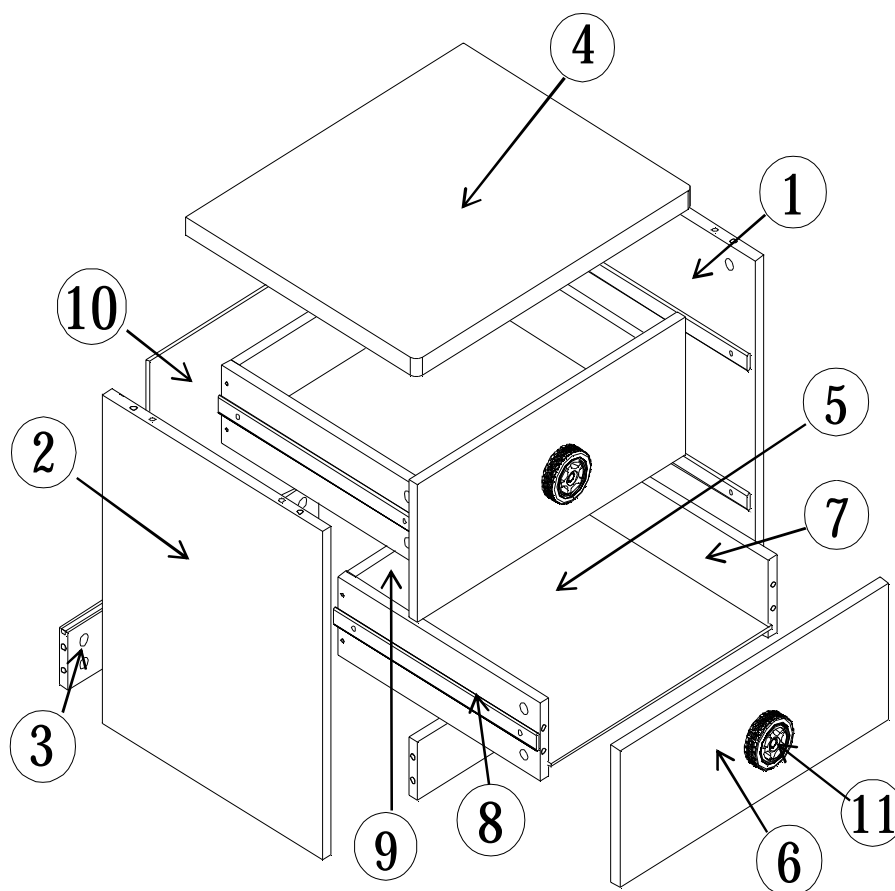

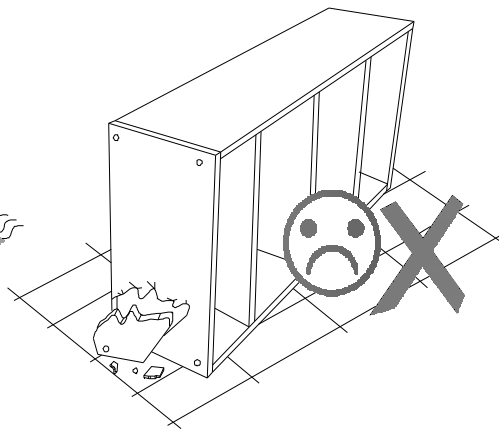
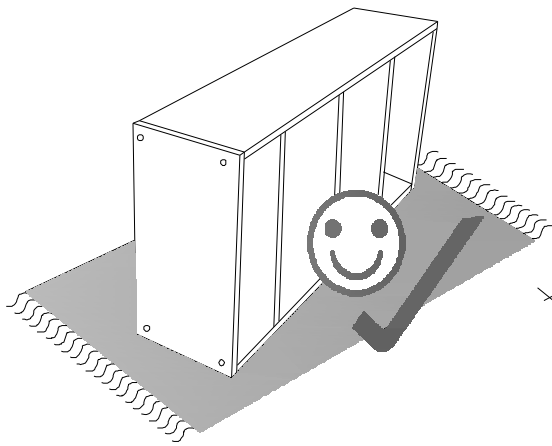

1

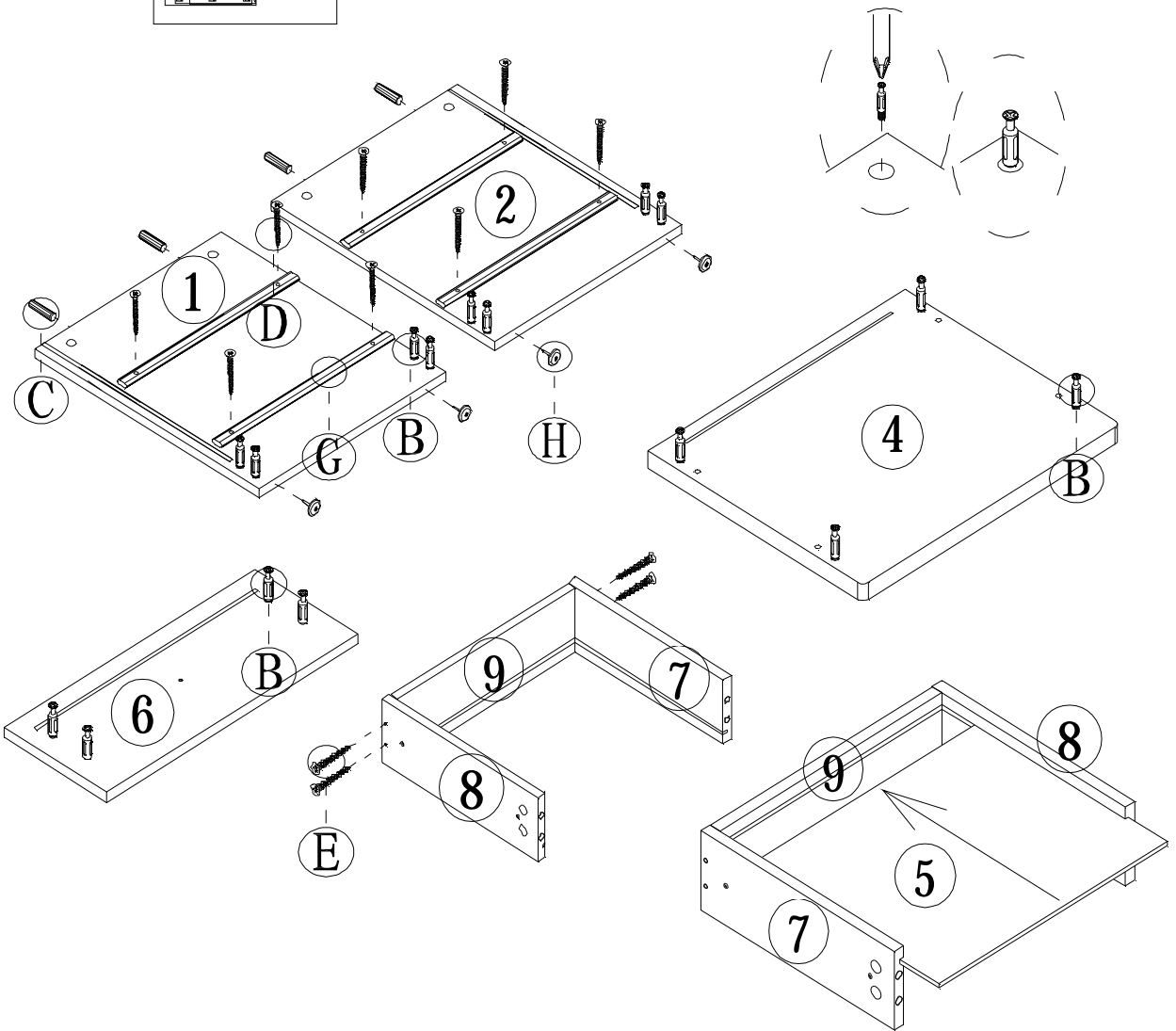
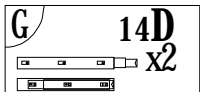
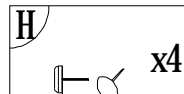
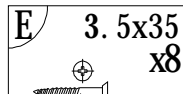
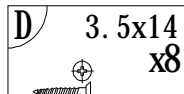
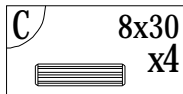
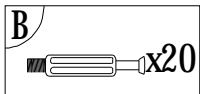

2

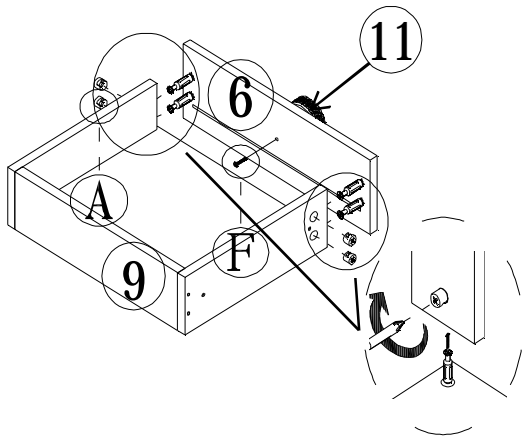
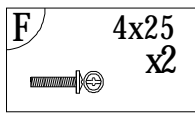
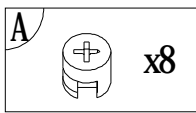

3

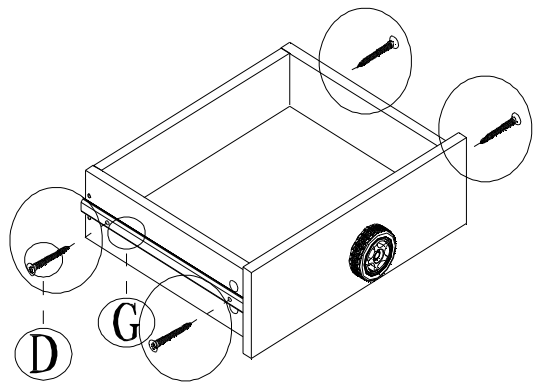
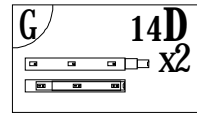
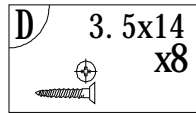

4

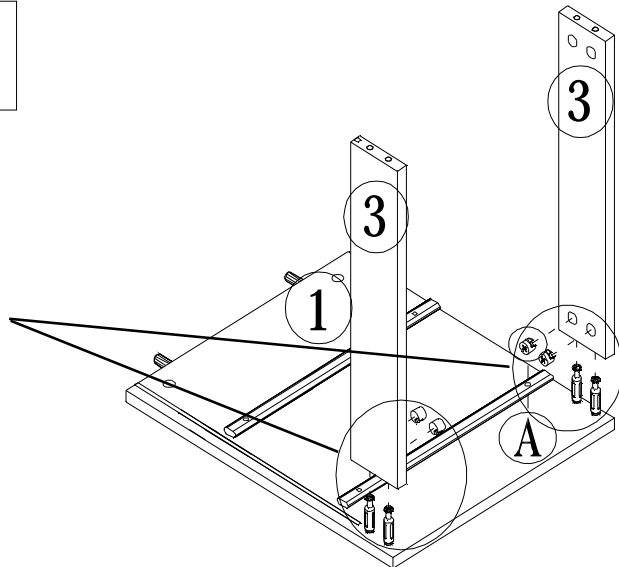
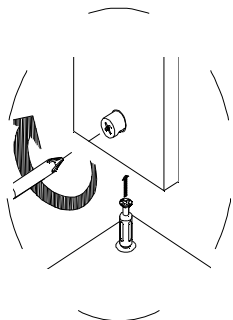
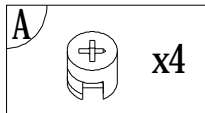

5

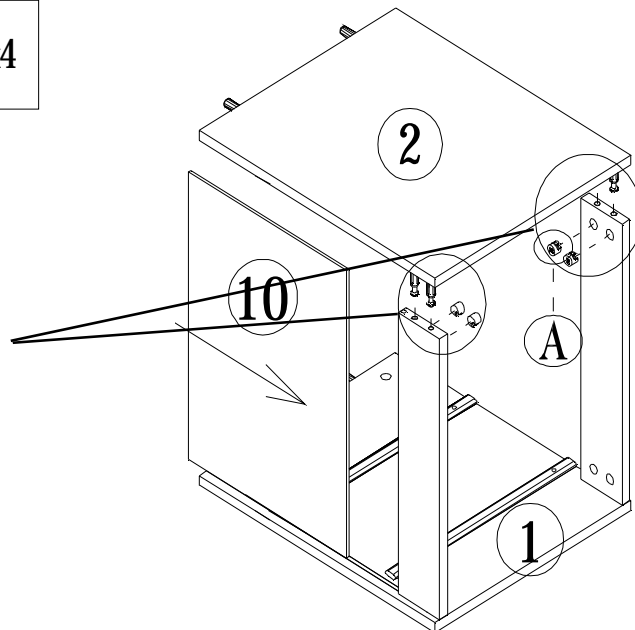
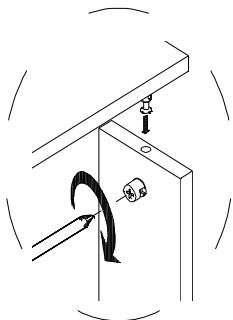
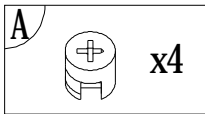

6

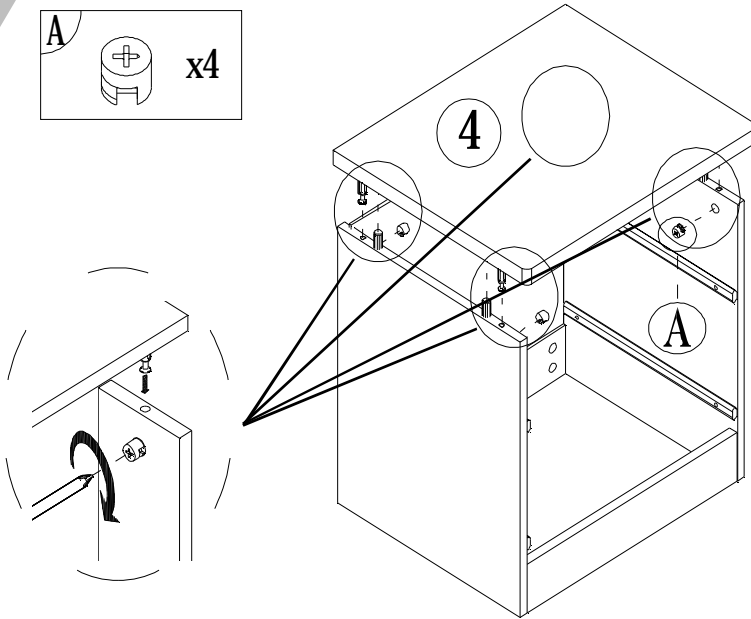
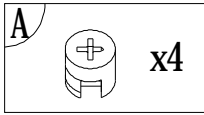

7

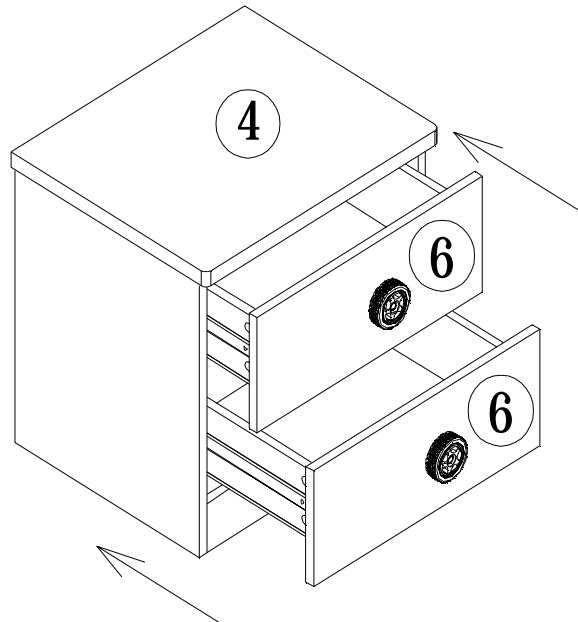

8

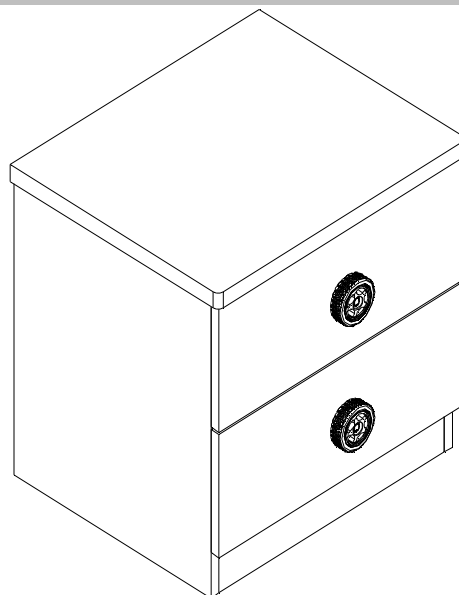

# Undetached Runner Instruction

