

Digital Camera

Instruction Manual

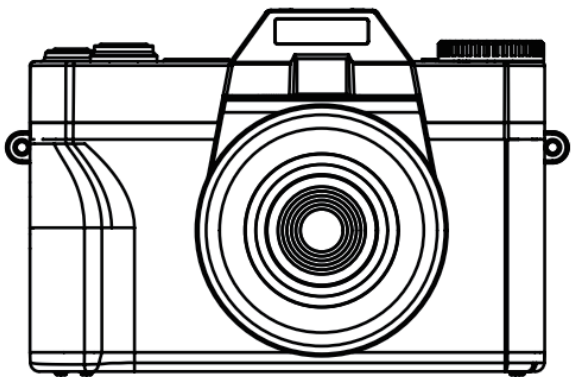

Preface

Thank you for purchasing this digital camera. Please read this manual before operating this product. After you finish reading this manual, store it in a safe place for future reference.

Contents covered in this user manual refer to the latest information in preparation of this user manual. Screen displays, illustrations, etc. adopted in this manual are intended to explain functions of the camera in detail. Due to differences in technology development and production batches, they may be slightly different from digital cameras you actually use.

Disclaimer notice: Considerable effort has been made to ensure that this manual is free of inaccuracies and omissions. However, there is no guarantee that there will be no errors or omissions in this manual.

Safety Precautions:

1. Be sure to read, understand and follow the safety precautions below when using the camera. Please make sure that the way you operate the camera is correct.
2. Do not point the camera directly at the sun or other strong light sources, or your eyesight may be damaged.
3. Do not trigger the flash in close to human or animal eyes. Your eyesight may be damaged when facing a strong light source if the distance is too close. Please pay close attention to keep more than 1 meter (39 inches) away from a baby.

4. Please store this equipment out of the reach of children and infants. It can cause serious injury to children if the camera or battery is accidentally damaged.
5. Do not attempt to disassemble or modify any part not described in this guide. Unpacking or modifying the camera may result in a high voltage shock. Internal inspection or warranty shall be the responsibility of qualified service personnel designated by company or corresponding camera dealer.
6. Please stop operating camera immediately if there are smoke or unpleasant smell on any parts of camera, otherwise it may cause fire or electric shock. Turn off camera immediately and remove camera's battery or unplug power cord from electrical outlet. Make sure the camera has stopped emitting smoke or an unpleasant smell.
7. Please stop operating camera immediately if you accidentally drop camera to the ground or damage its casing, otherwise it may cause fire or electric shock. Turn off camera immediately and remove camera's battery or unplug power cord from electrical outlet.
8. Do not expose or submerge the camera to water or other liquids. This camera is not waterproof. Please dry with a soft cloth if the case is exposed to liquid or salt water. Turn off camera immediately and remove camera's battery or unplug power cord from electrical outlet if water or other materials are exposed into the camera.
9. Do not store this equipment in a damp or dusty place.
10. Long sessions and extended use of the camera may

result in heat exposure of your hands. Please be careful when operating this equipment for an extended use of time.

11. Please unplug the battery if you not use the camera. The battery shall be charged once every 6 months. Use the camera again to discharge the battery when it is fully charged, so that lifecycle of the camera and battery can be maintained.

Part Name

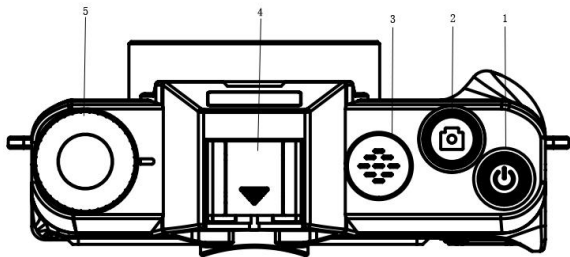

- 1:Power
- 2:Shoot button
- 3:Speaker
- 4:Hot-shoe
- 5:Mode button

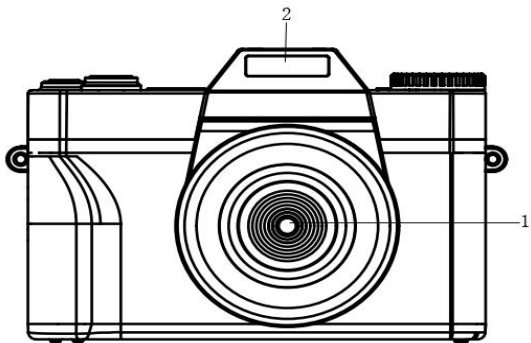

1: Lens

2: Flash

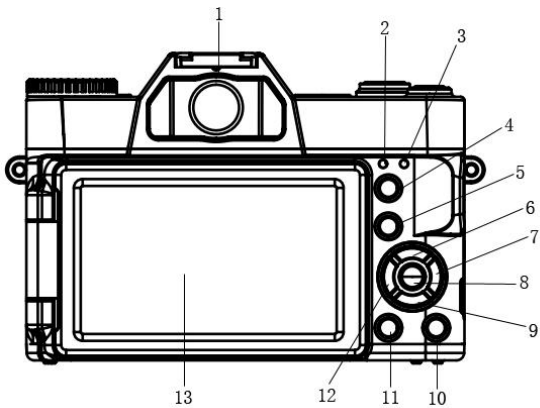

- | | |
|--------------------------------|------------------|
| 1: Hot-shoe | 8: OK |
| 2: Charging Indicator | 9: Down / Delete |
| 3: Working Indicator | 10: Menu |
| 4: T-Zoom in | 11: Display |
| 5: W- Zoom out | 12: Left / Delay |
| 6: Up / Flash light | 13: LCD display |
| 7: Right / Continuous shooting | |

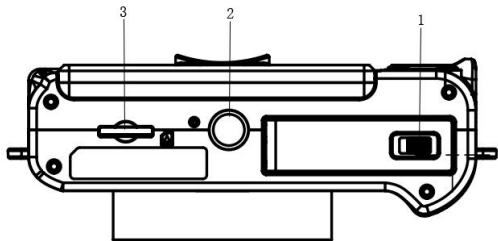

- 1: Battery door 2: Tripod slot 3: Memory slot

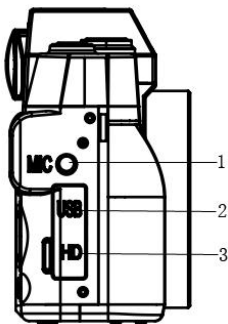

- 1: MIC interface
 2: USB interface
 3: HDMI interface





Preparation of the Camera

Install battery

This camera uses a high capacity rechargeable external lithium battery. Please put the battery into the battery slot correctly according to the battery and battery compartment slot.

Battery charging

The following symbols indicate the current remaining battery power.

icon	Remaining battery power
	60%-100%
	30%-60%
	5%-30%
	≤5%

When the battery logo is red, it means the battery needs to be charged. Please charge it in time, otherwise it may shut down automatically due to low battery.

(1) When charging with this camera, use USB line to connect the power adapter and the camera, and then connect the power supply to charge. When charging, the red light is always on, and the red light is off after fully charged.

Tips: The camera will turn on automatically when charging. The battery will be charged faster if the camera is turned off.

(2) When charging with standard external charger, put the

battery into the charger directly.

(3) Battery charging time (estimated) 3 hours.

(4) Continuous working hours (estimated)

When [system] is set to photo mode and all other settings are factory default settings, it can work for 1.5 hours.

When [system] is set to video mode and other resolutions, and all other settings are factory default settings, it can work for 1.5 hours.

Note: The battery is recommended to start charging in a temperature range of 10 ° C to 30 ° C. In a lower temperature, the battery may not be able to or need more time to be fully charged. When charging in a high temperature, it may shorten battery life.

The fully charged battery will naturally consume electricity. In order to ensure sufficient power, charging in advance is recommended.

When the camera is not used for a long time, please charge the battery every 3 months. Then let the battery discharge to maintain the battery life.

Install / remove memory card

The camera supports Micro SD (class 10) card expandable to 256GB. Insert the micro SD card in its designated slot with the label facing upwards. Make sure you hear/feel the proper click when inserting the SD card in its slot. In order to remove the memory card, simply push it inwards and it will come out automatically.

Notes:

- Turn the power off before replacing the memory card.



- Insert card in the correct direction. Do not force inserting the memory card you may risk damaging the camera or the card. Make sure the card is facing the correct direction when inserting it in the camera's memory slot.
- Please use a formatted memory card. It is not recommended to use a memory card if it's been used on other electronic devices or cameras.

The estimated recording time is just for reference and the specific time may be different depending on the memory card and battery condition.

	4K	2.7K	1080P		720P		
	30 FPS	30 FPS	60 FPS	30 FPS	120 FPS	60 FPS	30 FPS
16G	45	80	80	160	80	160	160
32G	90	170	170	300	170	300	300
64G	180	350	350	620	350	620	620
128G	360	720	720	1320	720	1320	1320
256G	720	1440	1440	2640	1440	2640	2640

unit: Min

Note: If there are documents not recorded by this camera or saved by a PC in the memory card, the recording time may be reduced or data may be unable to record properly.

Memory Card Formating

When using a memory card for the first time in this camera, it is recommended to format it in order to secure recording to function properly.

When first using a memory card in this camera, the format window will pop up automatically. As shown in the figure:

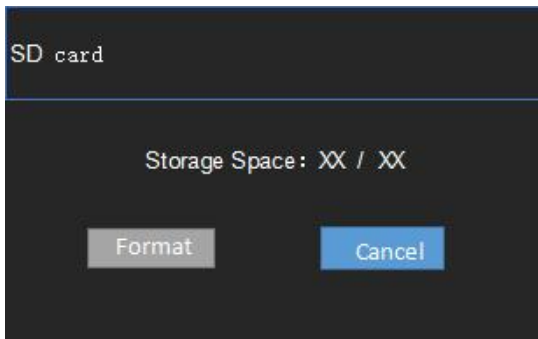

You can also enter the system menu of this camera sub-menu „format”, press OK button, and enter the format window in the above figure to carry out formatting. You can also format the memory card on your computer.

Turning on the power

Press the power button, until the indicator light of power turns on.



Set date/time

Press “MENU” twice to enter system setting menu, press Down button to find the “Time Set / Date Set” sub-menu, press “OK” to set corresponding date and time.

Language setting

Enter system setting, press the Down button to find the “Language” sub-menu, press “OK” to select the appropriate language.

Submenu catalog of system setting







Sub-menu	Menu content
Image Rotation	Turn On/Turn Off (Press OK to switch)
icon display	Open/Close
Light Source Frequency	Auto/50Hz/60Hz

LED Indicator	Turn On/Turn Off (Press OK to switch)
Auto Screen Saver	Turn Off/30s/1min/2min
Auto Power Off	Turn Off/3min/5min/10min
Button prompt Sound	High/Middle/Low/Turn Off
Startup Music	Open/Close
Language	Simplified Chinese/traditional Chinese/English/Japanese/Korean/Russian/German/French/Italian/Spanish/Portuguese/Thai
Time Format	YYYY/MM/DD MM/DD/YYYY DD/MM/YYYY
Time Set	hour minute second
Date Set	Year month day
Format	(Micro SD Card)Format/Cancel
Device Info	Product model and version number
Factory Reset	Confirm/Cancel

Mode Dial



Rotate the mode dial function to select the corresponding mode. The corresponding reference of the mode is as follows:

icon	Mode
	Photo
	Interval photography
	Recording
	Slow motion recording
	Time-lapse recording
	Playback

Take pictures

Set the mode dial to camera mode, the camera screen will

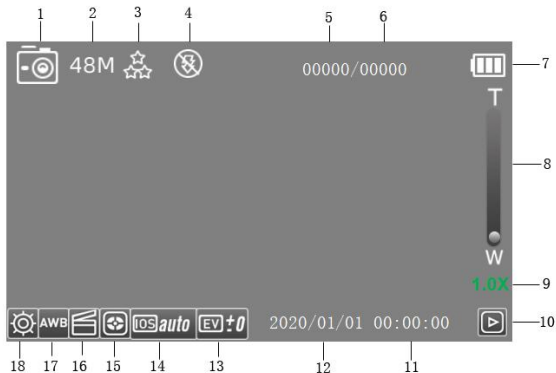

display the following interface.

1:Photo mode

2:Image pixels

3:Image quality

4:Fill light (turn off)

5:Current stored quantity

6:Current memory remaining storage

7:Current remaining battery power

8:Zoom in/Zoom out

9:Zoom factor

10:Playback

11:System time

12:System date

13:Exposure

14:ISO

15:Exposure Metering

16:Scene

17:White balance

18:Setting

Menu setting contents in photo mode

Sub-menu	Menu content
Pixellnset	48M/30M/24M/20M/12M/8M/5M/3M
White Balance	Auto/Sunny/Cloudy/Incandescent/

	Fluorescence
Scene	Auto / Sport / Portrait / Landscape / Dusk / Beach
Exposure Setting	-3/-2/-1/0/1/2/3
Metering Mode	Average Metering/Center Metering/Spot Metering/Matrix Metering
Image Quality	Super high quality / high quality / standard
Sharpness	High/Middle/Low
Long Exposure	Auto/2S/5S/10S/15S/20S/30S
ISO	Auto/100/200/400/800/1600/3200/6400
Time Watermark	Turn On/Turn Off (Press OK to switch)

Shooting auto focus function (AF)

In photography mode, the shoot button has two modes. When gently pressing the shoot button the camera will activate the auto focus automatically. By fully applying pressure on the shoot function, you will take the picture. (Focusing Range >0.33ft).

In video mode, the shoot button also has two layers. Gently press the first layer to focus, then press the second layer to

shoot.

1. When the distance between the camera and the object is more than 3.3ft, gently press the first layer of the shoot button, and the focus logo frame will appear on the display until the camera has focused clearly. Then the second layer of shoot button to capture the best clear video (the focus range is $> 3.3\text{ft}$);

2. When the distance between the camera and the object is more than 0.33ft and less than 3.3ft, gently press the first layer of the shoot button, and the focusing logo frame will appear on the display until the camera has focused clearly, then press the second layer of shoot button to start recording (Note: gently press the first layer of the shoot button and don't release your finger at this time), and shoot the best clear video (the focusing range: 0.33ft to 3.3ft).

Recording video

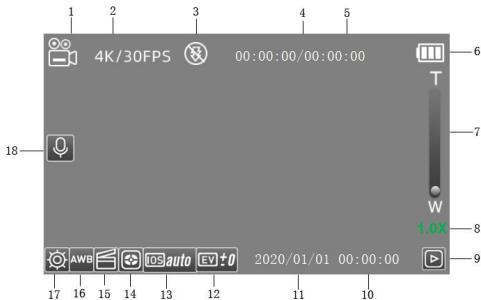

- 1: Recording mode
- 2: Video resolution
- 3: Fill light
- 4: Current recorded time
- 5: Current memory card remaining recording time
- 6: Current remaining battery power
- 7: Zoom in/Zoom out
- 8: Zoom factor
- 9: Playback
- 10: System time
- 11: System date
- 12: Exposure
- 13: ISO
- 14: Exposure Metering
- 15: Scene
- 16: White balance
- 17: Setting
- 18: MIC

Menu setting contents in video mode (In this mode, press MENU directly to set the corresponding menu)

Sub-menu	Menu content
Video Resolution	4K 30FPS 2.7K 30FPS 1080P 60FPS/30FPS 720P 120FPS/60FPS/30FPS
White Balance	Auto/Sunny/Cloudy/Incandescent/ Fluorescence
Scene	Auto / Sport / Portrait / Landscape / Dusk / Beach

Exposure Setting	-3/-2/-1/0/1/2/3
Metering Mode	Average Metering/Center Metering/Spot Metering/Matrix Metering
Sharpness	High/Middle/Low
Video Quality	High/Middle/Low
ISO	Auto/100/200/400/800/1600/3200/6400
Time Watermark	Turn On/Turn Off (Press OK to switch)
Record Audio	Turn On/Turn Off (Press OK to switch)

Video pause

This camera supports video pause. During the recording, press the Power button, the recording is stopped and press it again, the recording is continued. If pressing the record button again, the recording will end.

Tips: The recorded long video will be saved in the memory card in sections, and the document name is ***0000—***0000X.

PlayBack mode

Turn the mode dial to playback mode, and then press the Left or Right button to view the photos or videos. Press the down button to choose whether to delete the

current photo or video.



Power OFF

Long press POWER button to turn off the digital camera. If you set the auto turn off menu, when the digital camera is free, it will turn off automatically without operation in more than 3 min/5min/10min, so to save power.

Flash

This mode can be used to light up a dark environment or to give you extra lighting in a shot. Press the "up" button to quickly set to flash or no flash.

In the photo mode, press the "up,, button to quickly set the following three corresponding flash modes.

	No flash
	Auto flash
	Forced flash

In the recording mode, press the "up" button to quickly set two flash modes: no flash and forced flash.

MIC input

When an external microphone is needed, plug the external microphone into the MIC interface of video camera to record video or audio for better audio effects.

HD Output

When the video and sound of the video camera are needed to output to the HD TV, insert the public port of the HD cable into the HD interface of the video camera, and connect the HD input port to the HD input interface of the HDTV. Please stop recording / playing videos before accessing / unplugging the HD cable. (Switch TV signal into HD mode)

Connect computer and webcam

Connect the camera to the available USB port on the computer with the USB cable. After inserting the USB cable, the camera will automatically turn on. Press the up and down button to select the charging mode, storage mode or webcam mode, and press the OK to enter.

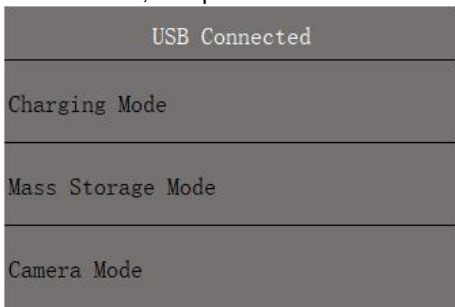

(1) Select charging mode, all functions of the camera can be used normally. The camera supports recording while charging.

(2) When the storage mode is selected, a new removable storage device will be added in the “My Computer” window, which will transfer photos and video files to the computer.

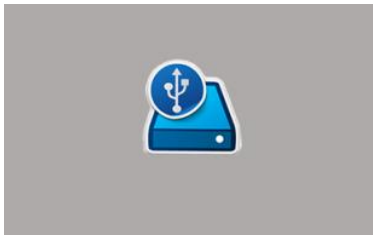

Note: do not disconnect the USB connection when downloading the file. Do not plug and unplug the memory card when connecting the USB, so as to avoid data loss.



(3) Select webcam mode, the camera can be used as a camera.

Tip: if the camera cannot be enabled after connection, please go to the device manager of the computer, find the image device menu or camera menu, and click to check

whether there is a UVC Camera device, if it is already connected. If it is a laptop with its own webcam, you need to disable its own webcam. Only then can the camera be used as a webcam.

Trouble	Measures
Camera can't start after battery is installed	The battery is low, please replace it with a new one.
	The battery is not installed in place; please confirm that the battery is installed correctly.
	There may be an error in the camera program, please pull out the battery, reinstall, and then turn on.
Unable to charge	If the charging indicator light is flashing, the battery is not installed in place or in poor contact. Please reinstall the battery until the indicator light is on for a long time (the indicator light will go out when the battery is full).
	If the charging indicator is not on, the charger is not plugged in. Please check whether the charger is connected normally.
HD cable cannot connect to the TV	Check whether the TV source is set to HD mode.
	Check if the HD wire is connected correctly.

Unable to connect to PC	Please check whether the USB data cable is connected correctly.
	Please check whether the USB interface of computer is working properly.
	Please check the compatibility of the computer system.
Blurred shooting effect	Check whether the camera shake when shooting.

Camera cleaning and maintenance

(1) If you do not use the camera for a long time, take out the camera battery and place it in a dust-free, dry environment with a temperature no higher than 30 °C.

(2) In order to extend the service life of the battery, please discharge it completely before storage.

(3) Please fully discharge the battery at least once every 3 months after it has been fully charged.

(4) If there is dust or dirt on the lens or screen, gently wipe it with a clean, soft lens cleaning cloth.

(5) As this machine is a precision instrument, please do not drop it or suffer from strong impact or vibration.

Additional notes

(1) Do not insert any object into the slot except the memory card.

(2) After the power is turned on, the camera may show an unstable image about for a few seconds, but this is not a

fault.

(3) Due to the optical properties of the lens, there may be color dispersion (magnification of chromatic aberration) at the edges of the image. This is not a camera fault.

(4) It is normal for the memory card to get hot after a long period of use.

(5) It is normal for the camera's screen to heat up after a long period of use.

Specifications

Items	Specification Parameter
Image Sensor	CMOS sensor, 48 million megapixel maximum
Camera Lens	Fixed lens F/2.4, f=5.04mm
Memory Card	Micro SD card (Maximum support 256GB)
Zoom	16X digital zoom
	No optical zoom
AF	Support(Normal auto focus Range of >10cm)
Photo sensibility	Auto/IOS100/ISO200/ISO400/ISO800/ISO1600/ISO3200/ISO6400
Static Image	Format:JPG
	Photo Resolution:3M,5M,8M,12M,20M,24M,30M,48M
Video Resolution	Format:MP4
	Video Resolution:
	4K_3840X2160 (30FPS)
	2.7K_2688X1520(30FPS)
	FHD_1920X1080(60FPS)
FHD_1920X1080(30FPS)	
HD_1280x720 (120/60/30FPS)	
External MIC	Support

Fill Light	<1.0m Range
White balance	Auto / sunny / cloudy / incandescent / fluorescent
Exposure	-3.0EV~+3.0EV
USB Interface	USB2.0 (high speed)
Auto Power-Off	Off /3mins /5mins /10mins
LCD Screen	3.0-inch ultra HD screen (16:9)
High-Definition Multimedia Interface	HDMI output interface
Language	English (default), Spanish, Portuguese, Russian, simplified Chinese, traditional Chinese, German, Italian, French, Japanese, Korean, Thai
Power Supply	lithium-ion battery
Compatible System	PC: Windows XP/Windows7/Windows8/Windows10/MAC