

REPC-Nr.:

Service • Assistenza • Dienstverlening • Serwis
Servis • Szerviz • Сервисная служба

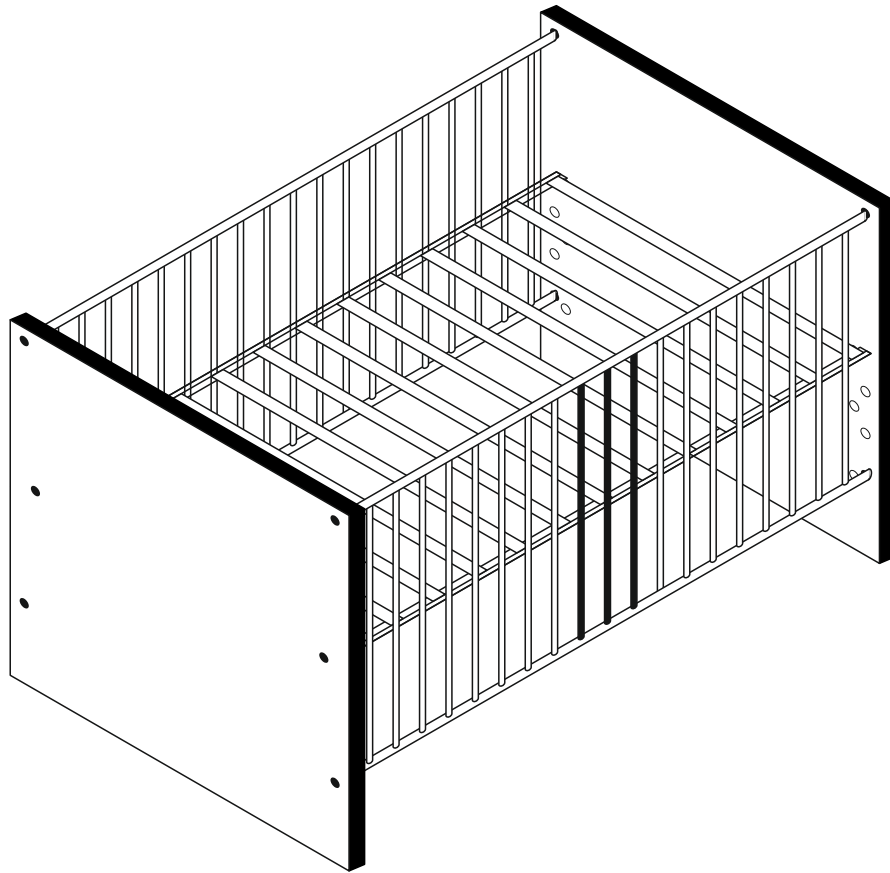

Artikel.-Nr.:

0427_BH

Montageanleitung.-Nr.:

MA1-00298

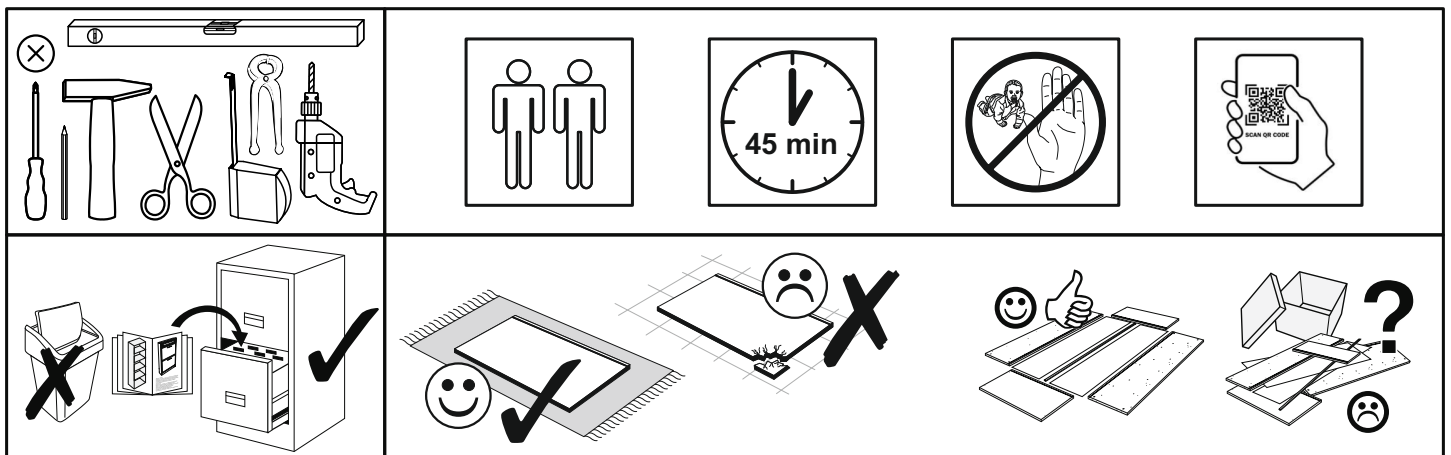

SCAN ME

Das Ersatzteil-Anforderungsformular finden Sie auf
The replacement parts requisition form you find on
<https://www.maeusbacher.de/ersatzteile/>

Beutel 0427_BH-P1 0-11 Colli 1/2

B01-179		B01-297		B01-330		B01-335		B05-273	
1x	6x35	12x	M 6x55	16x	M4x10	16x		1x	



▶ SCAN ME

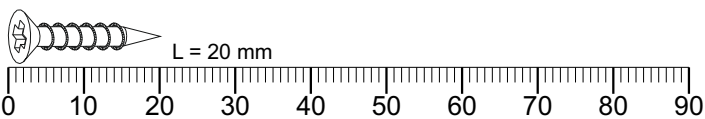

Colli 1/2

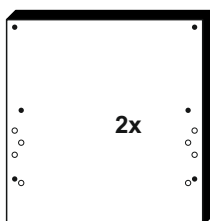

816 x 778

Bettenhaupter

Colli 2/2

Beutel BB-SP-Rund-P2 0-22 Colli 2/2

B10-05		B10-10		B10-15	
8x	Ø10/10	12x	M 6x65	1x	

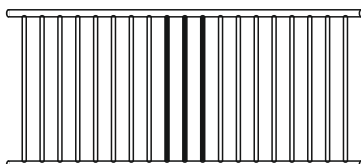

1388 x 630

Z27-15 1x

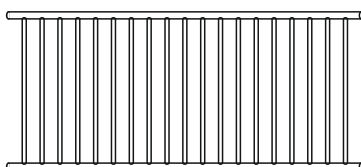

1388 x 630

Z27-20 1x

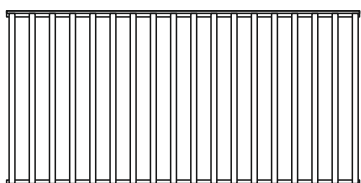

1388 x 680

Z27-10 1x

Colli 2/2

Beutel BB-SP-Breit-P2 0-22 Colli 2/2

B10-05		B10-10		B10-15	
8x	Ø10/10	12x	M 6x65	1x	

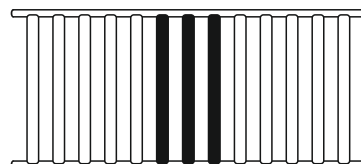

1388 x 642

Z27-16 1x

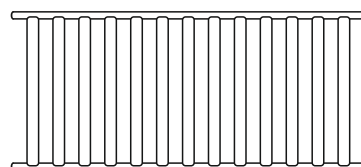

1388 x 642

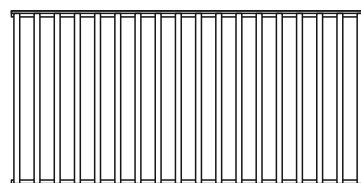

Z27-21 1x



1388 x 680

Z27-10 1x

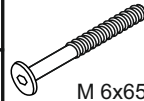
1

B10-05		B10-10		B10-15	
8x	Ø10/10	12x	M 6x65	1x	

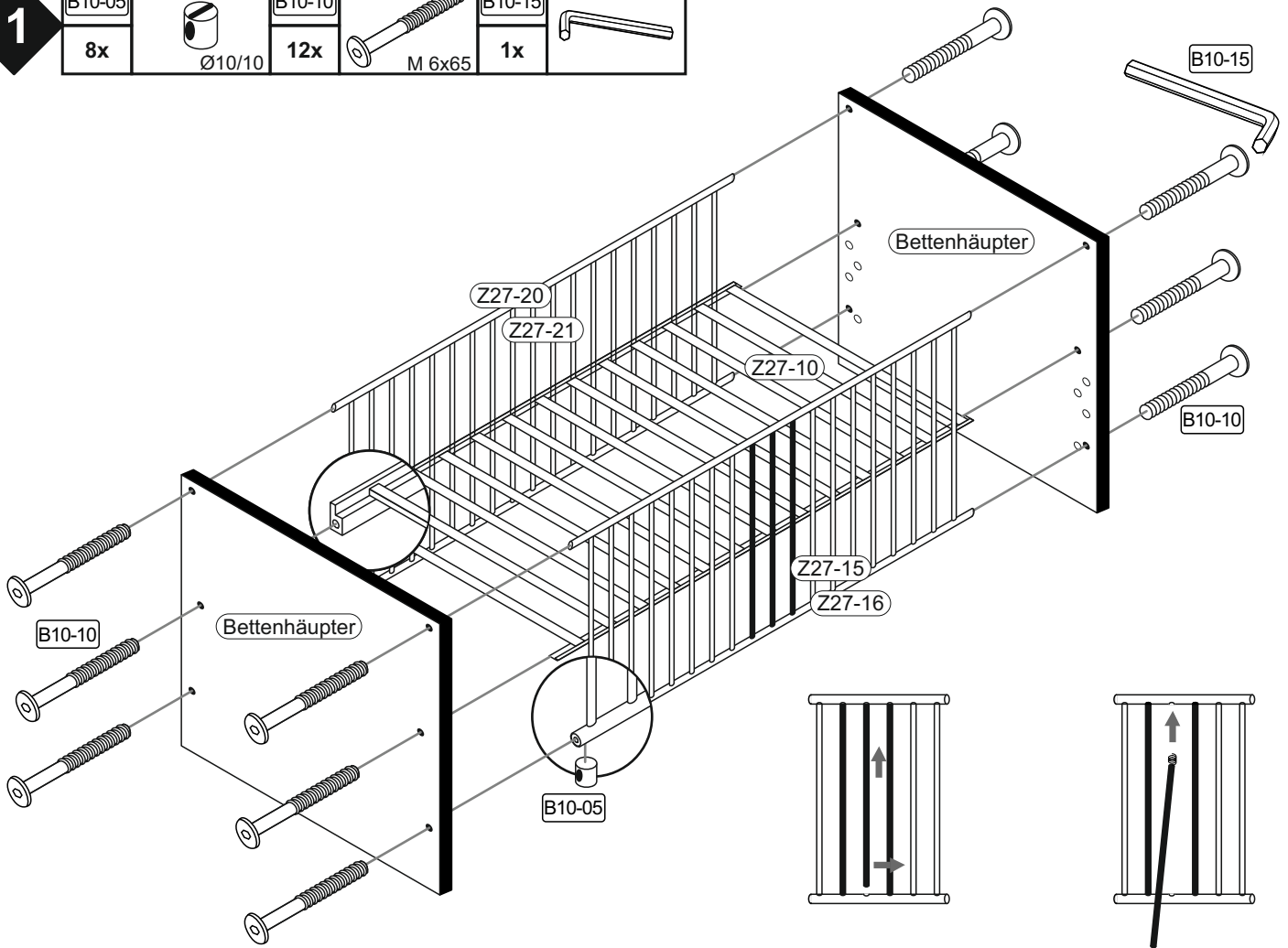

2

B05-273	
1x	

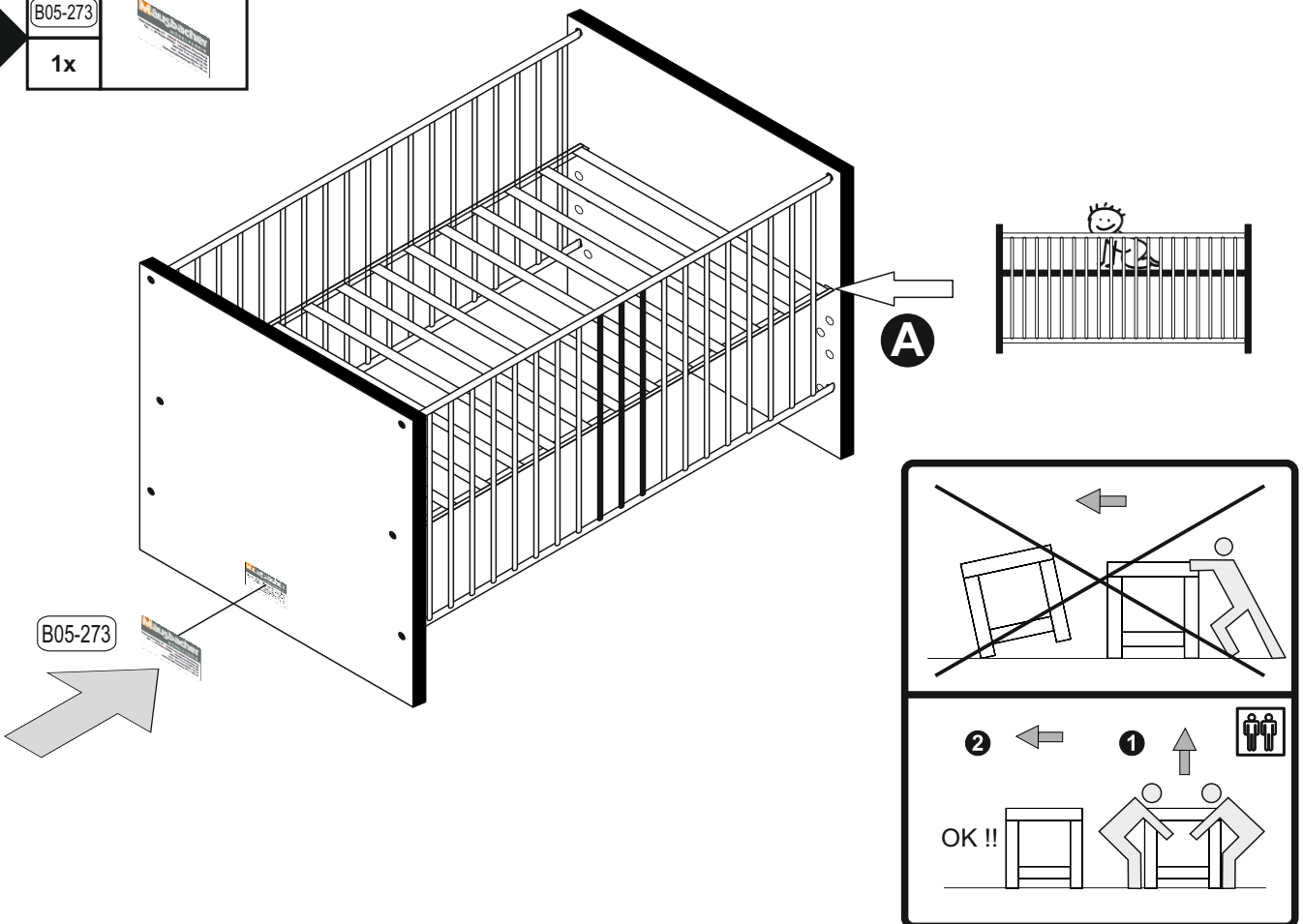

2.1	B01-179		B01-330	
	1x	6x35	4x	M4x10
	B01-335			
	4x			

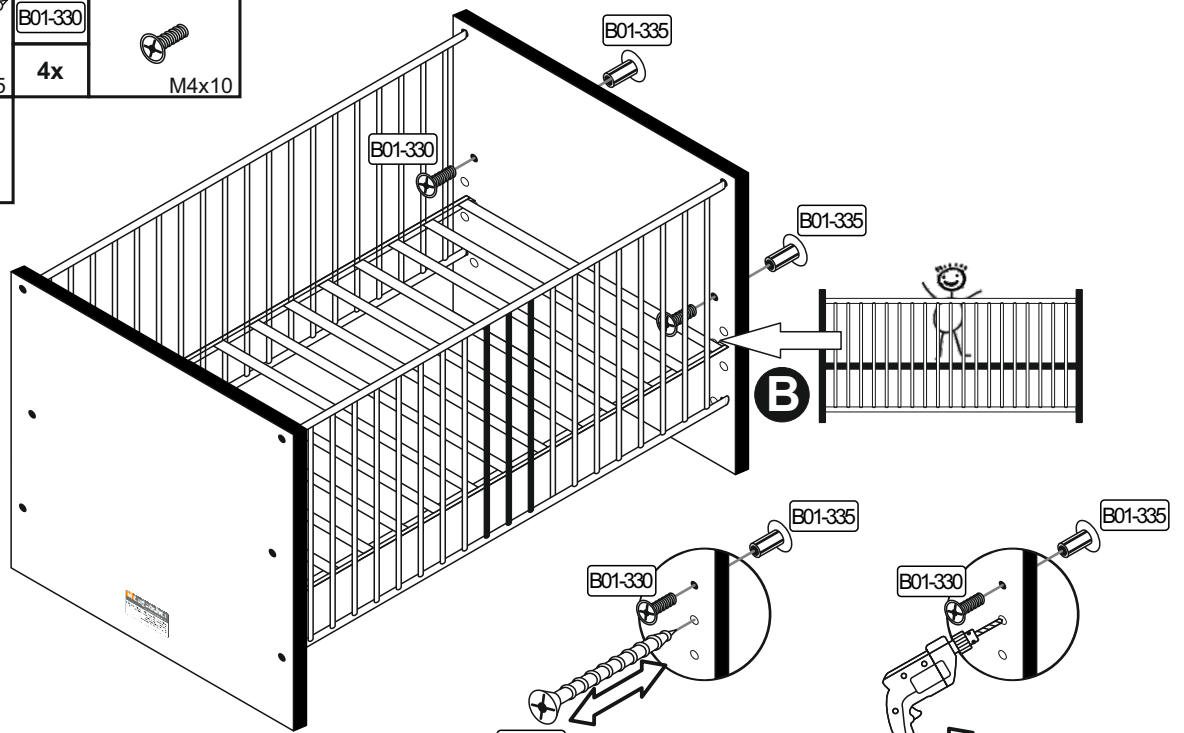

2.2	B01-179		B01-330	
	1x	6x35	4x	M4x10
	B01-335			
	4x			

