

LKZ:80407

Modellname / Model name / Nom du modèle / Modellnamn / Nome modello / Název modelu / Modelnaam / Ime modela / Número Modelo / Modell neve / Название модели / Názov modelu / Ime modela / Denumire model / Наименование на модела / Nazwa modelu

VITORIA

Modellnummer / Number / Numéro du modèle / Numero / Номер на модела / modello / Číslo modelu / Modell száma / Éislo modelu / Številka modela / Număr model / Broj modela / Modelnummer / Numer modelu

2431-131-14 

Type / Tipo / Típus / Тур / Тип / Tip

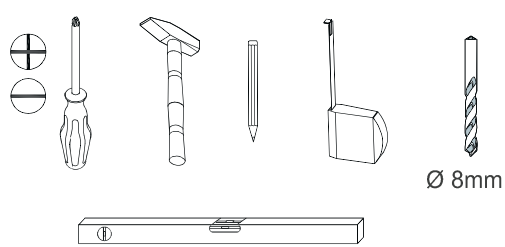
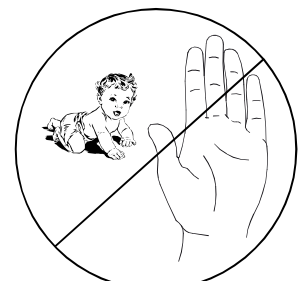
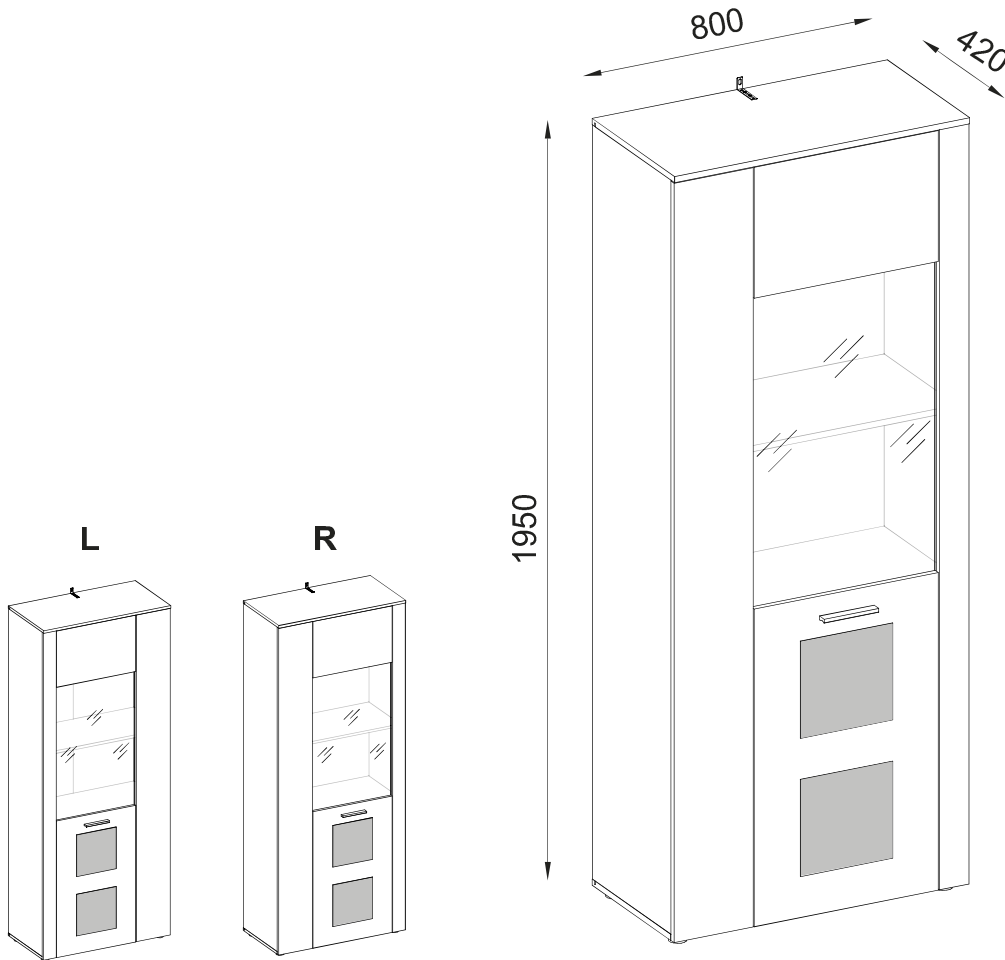
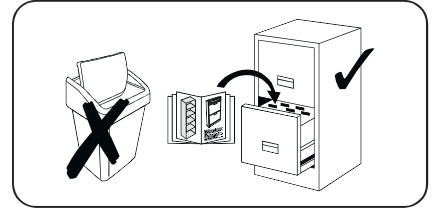
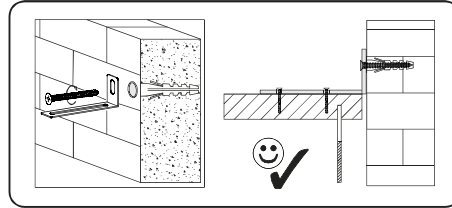
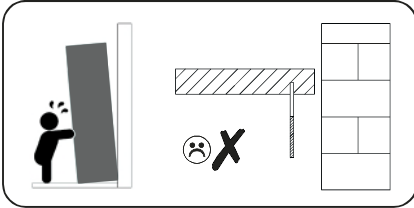
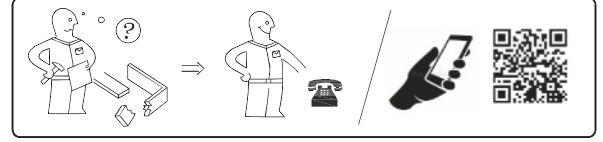
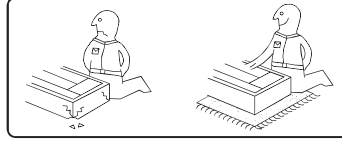
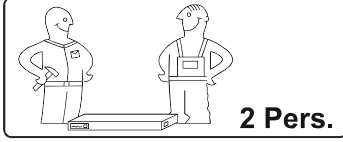

131



 **2 Pers.**

 **70 min.**

-  festziehen / tighten / Затягивать / serrer / stringere / utåhnut / vasttrekken / zategnuti / strângere / zwiázac / zacisnac / szorosan meghúzni / pevne dotiahnut' / trdno pritegniti / затянуть / dra át
-  eindrücken / press in / enfoncer / wcisnac / ribattere / zatlačit / Вкарайте / indrukken / benyomni / stlačit' / vtisniti / tryck in / introducere prin apăsare / вдавить
-  ausmessen / measure / mesurer / misurare / opmeten / izmeriti / miara / kimérni / izmeriti / măsurare / измерить / zméřit / Измерете / mät upp / zmierzyc

-  drücken / press / presser / stisknout / Натиснете / vtisniti / nasinac / drukken / pritisnuti / nacisnac / pritisniti / нажать / zarazit / Набийте / zabiti / wbić / introducere prin bătaie / забить / zatlout
-  einschlagen / hammer in / beverni / slain / frapper au marteau / infossare / Zabit' / zarazit / Набийте / zabiti / wbić / introducere prin bătaie / забить / zatlout
-  Drehen - wenden / przekreć - odwrócić / Keren - omdraaien / Girare - Ruotare / Okrenuti - ubnuti / Retourner - renverser / Turn over - turn around / Otočte - obratite / Завъртете - обърнете / Otočte - obratite / Intoarceți - rotiți / Vrid runt - vänd / прокрутить - повернуть / otočit - obrátit / otočit - obrátit / elforgatni - megfordítani

LKZ:80407

Modellname / Model name / Nom du modèle / Modellnamn
Nome modello / Název modelu / Modelnaam / Ime modela
Número Modelo / Modell neve / Название модели /
Názov modelu / Ime modela / Denumire model /
Наименование на модела / Nazwa modelu

VITORIA

Modellnummer / Number / Numéro du modèle
Numero / Номер на модела / modello
Číslo modelu / Modell száma / Éíslo modelu
Številka modela / Număr model / Broj modela
Modelnummer / Numer modelu

2431-131-14

Type / Tipo / Típus / Typ / Тип / Tip

131

D

Unser Direktservice für Beschlagteile

Sollte Ihnen ein Beschlagteil fehlen, können Sie diese Servicekarte direkt an die untenstehende Adresse mailen. Wir können allerdings nur Beschlagteile auf diesem Wege verschicken. Sollen Sie eine andere Beanstandung an Ihrem Möbelstück haben, so wenden Sie sich bitte direkt an Ihr Möbelhaus.

Our direct order service for fitting

If a fitting part is missing, you can e-mail this service card directly to the address below. However, we can only send fitting parts in this way. If you have any other cause for complaint concerning your item of furniture, please contact your furniture store directly.

Naše přímé služby pro kování

Chybi-li vám nějaký díl z kování, můžete tuto servisní kartu odeslat e-mailem přímo na níže uvedenou adresu. Touto cestou však můžeme rozesílat jen díly kování. Pokud byste reklamovali jiný díl nábytku, obraťte se přímo na svého prodejce nábytku.

Bien étudier la notice de montage

S'il vous manque une ferrure, veuillez envoyer directement la présente carte service à l'adresse e-mail indiquée ci-dessous. Cependant, ceci nous permet uniquement d'envoyer des ferrures. Pour tout autre type de réclamation concernant votre meuble, veuillez contacter directement votre magasin d'ameublement.

Il nostro servizio diretto per l'ordine della ferramenta

Qualora Vi dovesse mancare un pezzo di fissaggio, allora Vi preghiamo di inviare questa carta di servizio immediatamente all'indirizzo sottostante. Possiamo inviare i pezzi di fissaggio solamente per mezzo di questo procedimento. Qualora dovete avere qualche altra reclamazione in merito al mobile, allora Vi preghiamo di rivolgerVi direttamente al Vostro Negozio di mobili.

Нашата директна услуга за обков

Ако липсват части от комплекта, попълнете настоящата сервисна карта и ни я изпратете на e-mail адреса, посочен по-долу. По този начин можем да доставяме само липсващи елементи от обкова. Ако установите други дефекти по мебелите, Ви съветваме да се обърнете към мебелната къща/магазин, от който сте закупили стоката.

Onze directservice voor losse onderdelen

Wanneer er een onderdeel ontbreekt, kunt u deze servicekaart direct aan onderstaand e-mailadres sturen. Wij kunnen langs deze weg echter alleen beslagdelen versturen. Mocht u een ander probleem aan uw meubel hebben, verzoeken wij u contact op te nemen met uw meubeldealer.

Nasz bezpośredni serwis czesci montazowych

Jeżeli brakuje części koniecznych do montażu, prosimy o przesłanie nam niniejszej karty serwisowej na niżej podany adres e-mailowy. W ten sposób możemy przesyłać Państwu tylko brakujące części. W przypadku innych reklamacji dotyczących mebla, prosimy zgłosić się do salonu meblowego, w którym został dokonany zakup.

Servis za okove

U slučaju da nedostaje neki od dijelova molimo vas da na dolje navedenu mail adresu pošaljete ovaj servisni obrazac. Na ovaj način mogu se dostaviti samo okovi. U slučaju da imate dodatne prigovore vezane uz komad namještaja molimo vas da se obratite izravno trgovini namještaja gdje je isti kupljen.

Direktszolgáltatunk vasalatok esetén

Ha hiányzik egy vasalat, ezt a kártyát közvetlenül elküldheti az alábbi e-mail címre. Azonban csak vasalatoskat tudunk így küldeni. Amennyiben másfajta reklamáció áll fenn bútordarabját illetően, forduljon közvetlenül a bútorházhoz.

Náš priamy servis pre časti kovania

Ak by Vám chýbala nejaká časť kovania, môžete poslať túto servisnú kartu poslať e-mailom na nižšie uvedenú adresu. Diely kovania vieme poslať iba týmto spôsobom. Ak by ste mali inú reklamáciu oľhadom Vášho nábytku, obraťte sa priamo na Vašu predajnú nábytku.

Naše direktné služne storitve za okovje

Ce vam manjka kakšno okovje, lahko to servisno kartico pošljete po e-pošti direktno na spodnji naslov. Po tej poti vam lahko pošljemo samo okovje. Če želite reklamirati kakšen drug del pohištva, se obrnite neposredno na vašo trgovino pohištva.

Service-ul nostru direct pentru feronerie

În cazul în care vă lipsește o piesă de feronerie puteți să trimiteți direct acest card de service prin e-mail la adresa de mai jos. Noi nu putem expedia piese de feronerie decât pe această cale. Dacă aveți o altă reclamație referitoare la piesă de mobilier, atunci vă rugăm să vă adresați direct la magazinul dvs. de mobilă.

Наш прямой сервис для поставок фурнитуры

Если окажется, что Вам не хватает того или иного элемента фурнитуры, Вы можете отправить сервисную карту по факсу непосредственно на нижеприведенный адрес электронной почты. Однако, таким образом мы можем пересылать лишь фурнитуру. Если же у Вас возникнут иные претензии относительно приобретенной мебели, пожалуйста, обращайтесь непосредственно в организацию, осуществившую продажу.

Vår direktservice för beslagsdelar

Om du saknar en beslagsdel kan du skicka detta servicekort direkt till e-postadressen som anges nedan. Tänk på att detta är den enda möjligheten att skicka beslagsdelar till dig. Om du vill reklamera din möbel av en annan anledning måste du kontakta ditt möbelhus direkt.

Nuestro servicio directo para accesorios

Si le falta algún accesorio, puede enviar esta tarjeta de servicio directamente a la siguiente dirección. No obstante, por este método solo podemos enviar accesorios. Si tiene alguna otra objeción sobre su mueble, consulte directamente con su mueblería.

Donatilar için doğrudan servisimiz

Bir donatınız eksikse bu servis kartını doğrudan aşağıda bulunan adrese doğrudan mail yazabilirsiniz. Sadece bu yolla donatıları gönderebiliriz. Mobilyanızda başka şikayetleriniz varsa lütfen doğrudan mobilya satıcınıza danışın.

GB

CZ

F

I

BG

NL

PL

HR

HU

SK

SLO

RO

RUS

S

ES

TR



= 3 4 5 6

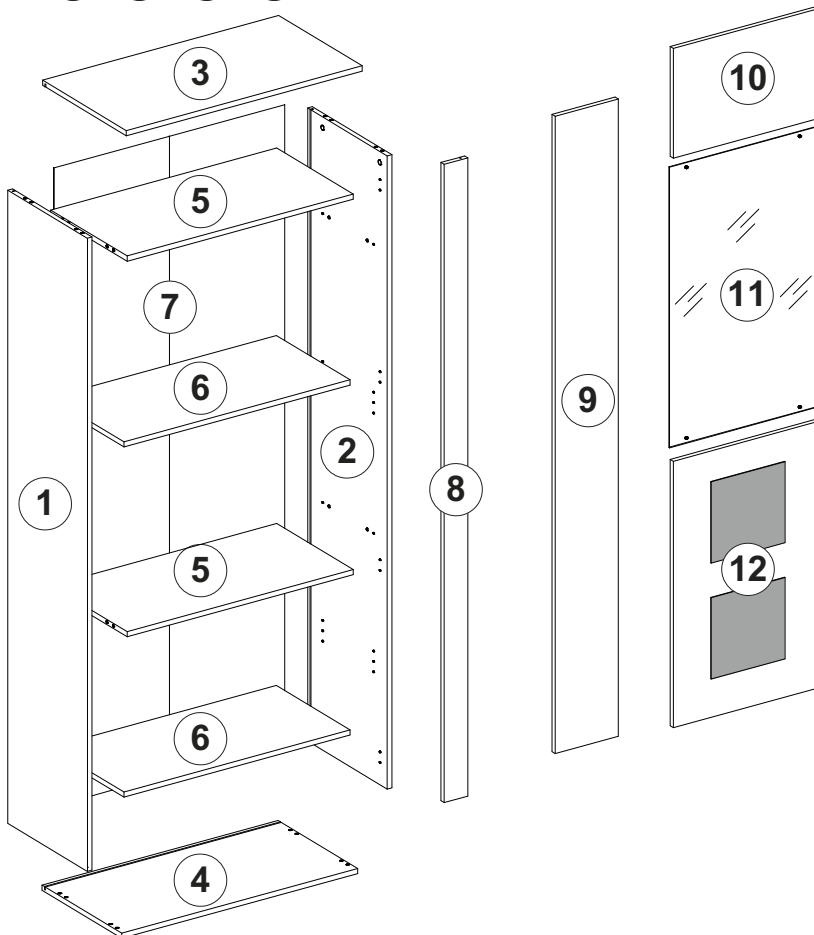

A	B (mm)		C	D
1	1898	400	16	x1 2/2
2	1898	400	16	x1 2/2
3	800	420	16	x1 1/2
4	800	400	16	x1 1/2
5	766	384	16	x2 1/2
6	766	370	16	x2 1/2
7	1914	782	2,5	x1 2/2
8	1914	80	16	x1 2/2
9	1911	214	16	x1 2/2

A	B (mm)		C	D
10	288	499	16	x1 2/2
11	499	863	4	x1 2/2
12	820	499	19	x1 2/2
B1				1/2

Grund der Beanstandung / Cause for complaint:

Möbelhaus / Furniture store:

Kunde/ Customer:

Telefon / Telephone:

PLZ / Postcode:

Ort / City:

Str. +Nr / Street address:

@E-Mail:

LKZ:80407

Modellname / Model name / Nom du modèle / Modellnamn
Nome modello / Název modelu / Modelnaam / Ime modela
Número Modelo / Modell neve / Название модели /
Názov modelu / Ime modela / Denumire model /
Наименование на модела / Nazwa modelu

VITORIA











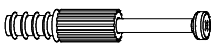
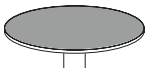
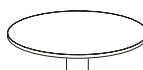
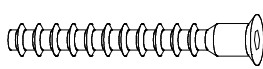
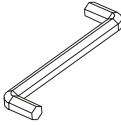

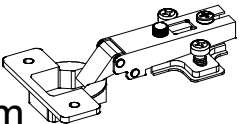

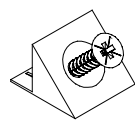
Modellnummer / Number / Numéro du modèle
Numero / Номер на модела / modello
Číslo modelu / Modell száma / Eíslo modelu
Številka modela / Număr model / Broj modela
Modelnummer / Numer modelu

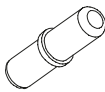
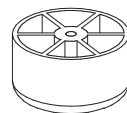
2431-131-14

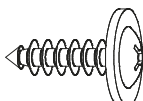
Type / Tipo / Típus / Тип / Тип / Tip

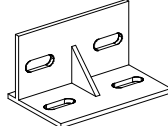
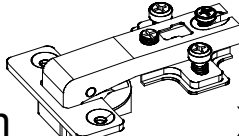
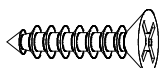
131

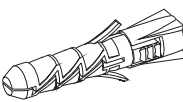
B1 Colli 1/2

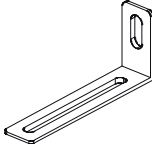
A1 15x12  x12	C2 44mm  x12	O1 ø18mm  x8
O2 ø18mm  x4	F3 6,3x50  x4	FA1 4mm  x1
B2 8x30  x16	K6 ø35mm  x4	J65 128/148  x1
M1 10x10x15  x16	R5 ø6mm  x6	N1 ø6mm  x8
P18 45x20  x4	N5 10x6x10  x4	DB2 4x25  x2
DA21 4,2x16  x24	D25 4x25  x4	T1 30x35x55  x4
K9 ø35mm  x3	D11 3,5x16  x16	R6 ø35mm  x3
Y37 8x50  x1	O5 ø8  x2	Y35 4,2x65  x1
Y36 75x35x15  x1		

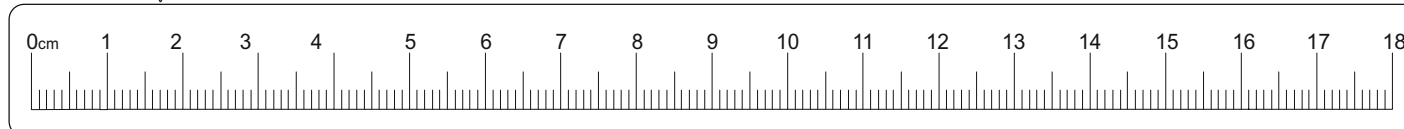
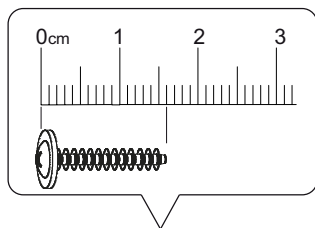

Değerli müşterimiz, evde kullanım için tasarlanan iç mekan programımızdan bir mobilya satın aldığınız için teşekkür ederiz. Lütfen teslimat kapsamının eksiksiz olup olmadığını kontrol edin ve montajdan önce aşağıdaki önemli bilgileri dikkatlice okuyun ve daha sonra üçüncü şahıslar tarafından da kullanılmak üzere saklayın.

Mobilyalarımız amaçlandığı şekilde kullanılmalıdır. Amacı dışında kullanım, maddi hasarlara veya bazı durumlarda kişisel yaralanmalara neden olabilir. Mobilyalar çocuk oyuncuğu değildir. Üretici veya satıcı, amacı dışında veya yanlış kullanımdan kaynaklanan hasarlar için hiçbir sorumluluk kabul etmez.

D İ K K A T: Çocuklar veya zihinsel engelli kişiler, yaralanma ve/veya bozulma riski bulunduğundan, mobilya parçalarından, sivri uçlu nesnelere, küçük parçalardan ve ambalaj malzemelerinden daima uzak tutulmalıdır.

M O N T A J: Montaj sırasında lütfen işlemin, kullanım, kurulum veya montaj talimatlarınıza uyun ve uyan ve güvenlik talimatlarına özellikle dikkat edin. Talimatlara uyulmaması, kişisel yaralanmaya veya mobilya hasarına/güvenlik riskine neden olabilir.

Montaj / kurulum konusunda zorluk yaşıyorsanız, lütfen servis ekibimize iletişime geçin. Ekibimiz tavsiyelerini ve desteklerini size yardımcı olacaktır. Montaj sadece uzman kişiler tarafından yapılmalıdır.

Ürün/ürün parçalarında değişiklikler, üreticiden/satıcıdan gelmeyen parçalarla/sarf malzemeleriyle değiştirilmesi veya kullanılması durumunda meydana gelebilecek hasarlar için sorumluluk kabul edilmez.

Ürünlere dübel ve vida gibi duvara sabitleme araçları eklenmişse, bunlar sadece sağlam ve tek tip malzemelerden yapılmış duvarlarda kullanılmak üzere tasarlanmıştır. Bir bağlantı sadece bağlantı elemanı ve duvar arasındaki bağlantı kadar iyidir. Lütfen mobilyayı sabitlemeden önce duvarınızın hem ayakta hem de asılı mobilya için uygunluğunu kontrol edin ve sadece uygun bağlantı elemanları kullanın. Olası bir delme işleminden önce delme alanında tesviye olduğundan emin olun. Sonuçta, montajı yapan kişi duvara sabitlemekten sorumludur.

Bu aynı zamanda elektrikli parçaların ve diğer yapısal aksesuarların montajı için de geçerlidir. Elektrikli parçaların ve diğer aksesuarların montajı/kurulumu sadece yetkili uzman personel tarafından yapılabilir. Tüm elektrik ve yapısal kurulumlar, eyletinizdeki geçerli standartlara ve güvenlik yönetmeliklerine uygun olarak yapılmalıdır.

Işık kaynakları için lütfen sadece izin verilen aydınlatma güçlerini kullanın. Maksimum Watt değerine uyulmaması durumunda aşırı ısınma nedeniyle yangın riski söz konusudur. Yangın tehlikesi nedeniyle aydınlatmaların üstünü kapatmak yasaktır.

Mobilyaların düzgün fonksiyonu sadece düz ve yatay konumda garanti edilir. Kapılar önceden ayarlanmıştır, ancak yerel koşullar nedeniyle yeniden hizalanması/ayarlanması gerekebilir. Lütfen maksimum yükte ilgili ağırlık bilgilerine uyun. Mobilyaların üzerine çıkılması yasaktır. Yanlış kullanım mobilyaların devrilmesine neden olabilir.

Bunu önlemek için mobilyalar her zaman devrilmeye karşı emniyetli alınmalıdır. Aşırı yük/aşırı zorlama durumunda (özellikle oyun oynayan çocuklar, insanlar, malzeme veya diğer uygunsuz etkilere nedeniyle) kırılma ve yaralanma riski söz konusudur. Kalıcı sağlamlığı güvenceye almak için tüm vidalar ve yük taşıyan bağlantı noktaları 5-6 hafta sonra tekrar sıkılmalıdır.

B A K I M:
-Mobilya bakımıyla ilgili notlar-
Ürünümüzün keyfini abidince uzun süre çıkarabilemeniz için lütfen uygun mobilya bakımıyla ilgili talimatlarımızı dikkate alın.

Temizlik sırasında temiz, kuru ve yumuşak pamuklu bir bez kullanın. Mobilyanızın kapsamlı bir temizliğe ihtiyacı varsa, bezi biraz su veya mobilya temizleyicisiyle nemlendirilebilir ve ardından temizlenen eşyaları kurutabilirsiniz. Metal ve cam parçaları, üzerindeki bakım talimatlarına göre piyasada bulunan metal ve cam temizleyicilerle en iyi şekilde temizleyebilirsiniz. Temizlik maddeleri, mobilya temizliği için uygun olduklarının açık bir göstergesini taşımaz.

Hiçbir koşulda buharlı temizleyiciler, kostik, aşındırıcı veya etkilerine aşına olmadığınız diğer maddeleri kullanmamalısınız.

D İ K K A T: Çok parlak yüzeyler teslimat sırasında koruyucu bir folyoyle korunur. Bunu tamamen monte edilene ve tozu temizlenene kadar mobilya üzerinde bırakın. Koruyucu folyonun çıkarıldığı çok parlak elemanlar ancak 72 saat sonra temizlenebilir ve kullanılabilir (ortam havasında son katlaşma süresi). Yüzeylere keskin nesnelere zarar vermeyin ve asla güçlü güneş ışığına maruz bırakmayın.

T A S F İ Y E
-Tasfiyeyle ilgili notlar-
Çevre için lütfen türüne göre ayrılmış ambalaj atıklarını doğaya değil, bunları için sağlanan atık/geri dönüşüm kutularında tasfiye edin.

Hasarlı veya kullanılmaz mobilyalar, her bir parçanın geri dönüştürülmesi için özel geri kazanım tesislerine gönderilebilir.

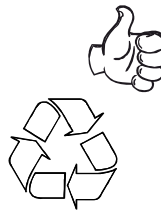
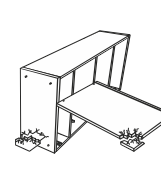
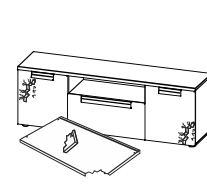
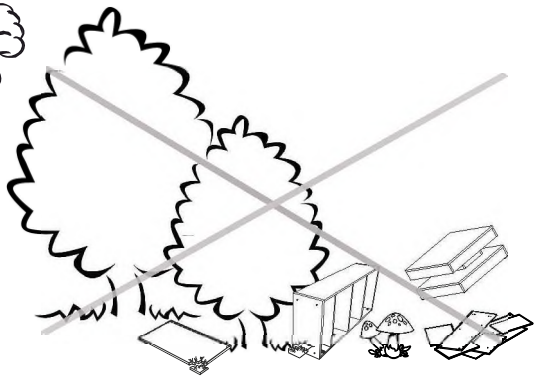
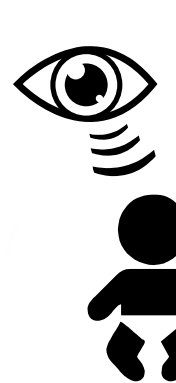
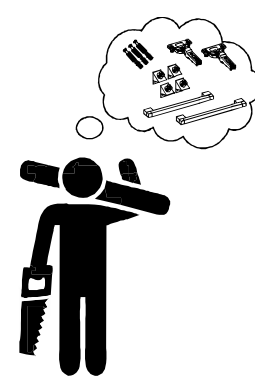
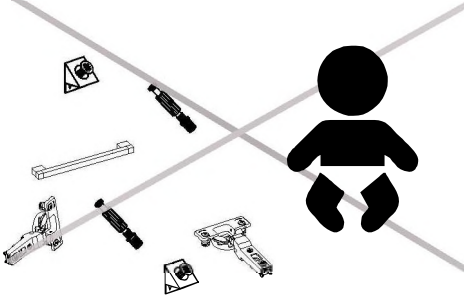
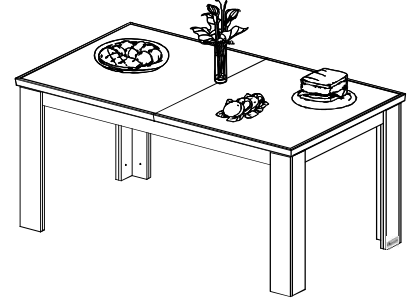
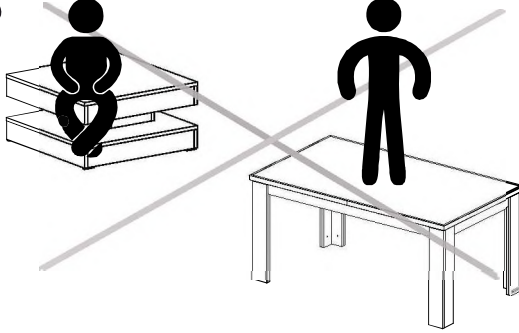
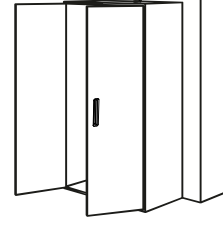
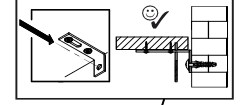
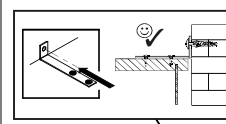
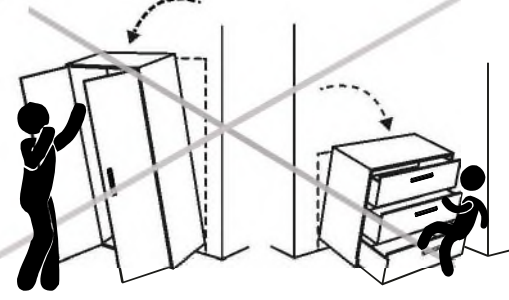

Artık kullanılmayan ancak hala işlevsel olan mobilyaların hemen tasfiye edilmesi gerekmez. Bunları örneğin hayır kurumlarına bağışlayın.

Yeni mobilyalarınızı güle güle kullanın.

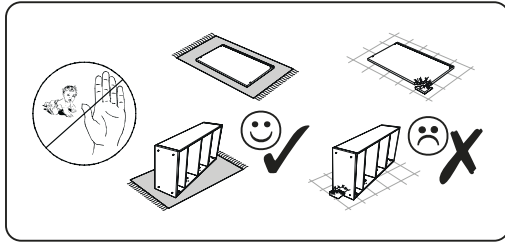

1



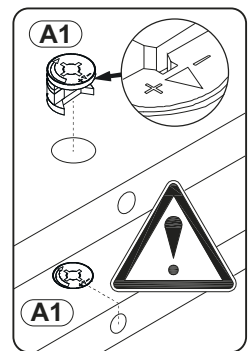
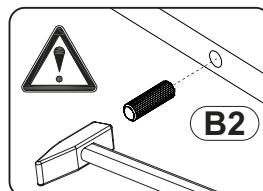
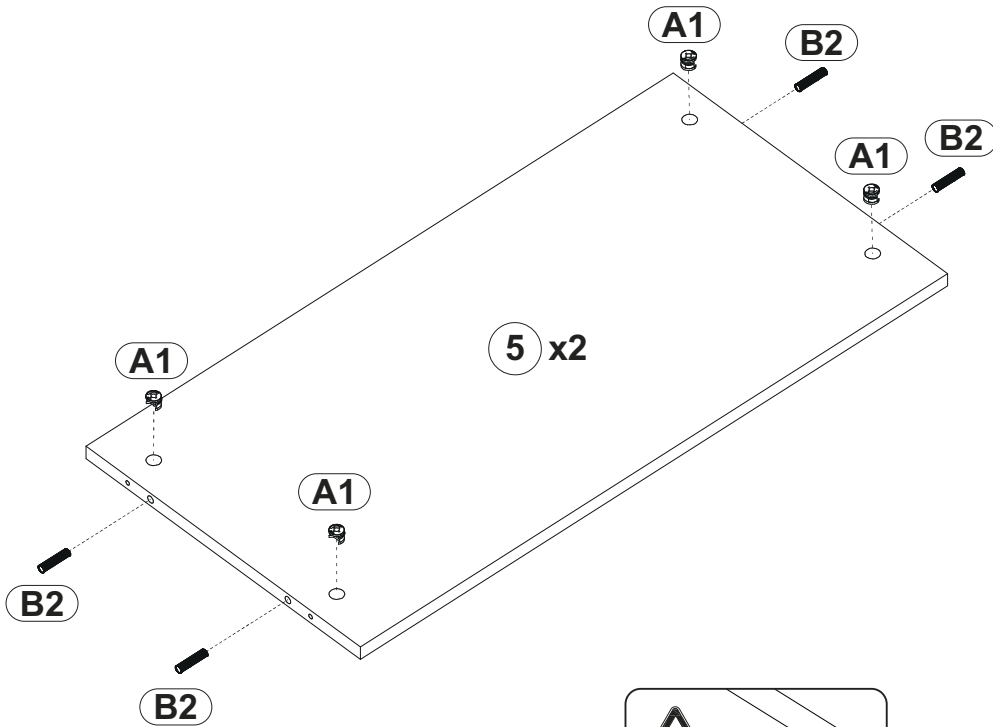
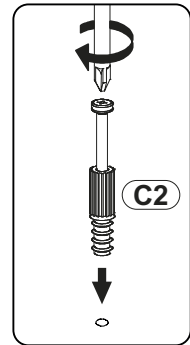
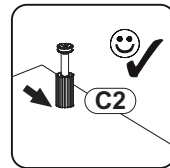
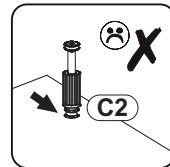
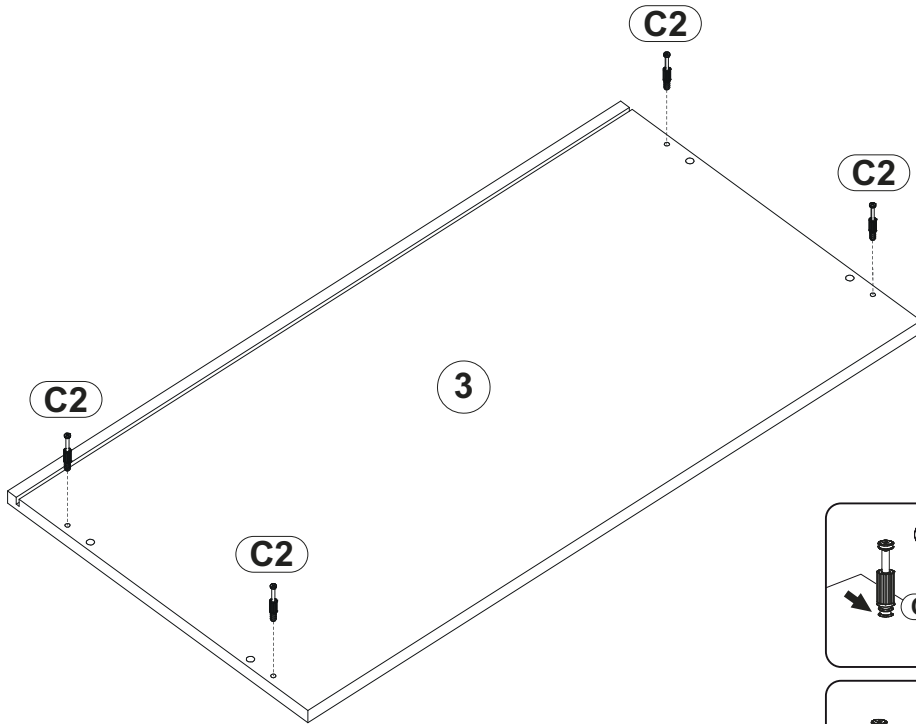

A1		x8
15x12		
C2		x4
44mm		
B2		x8
8x30		

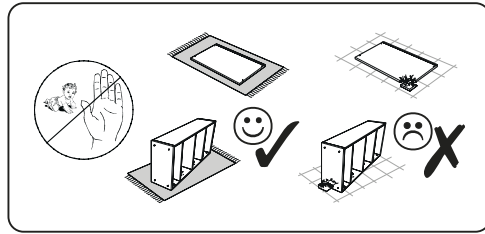

2

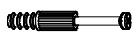

A1		x4
15x12		
C2		x8
44mm		
B2		x8
8x30		
N1		x8
ø6mm		

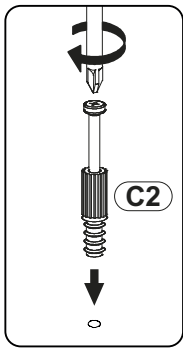
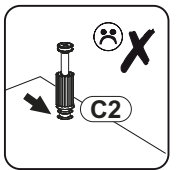
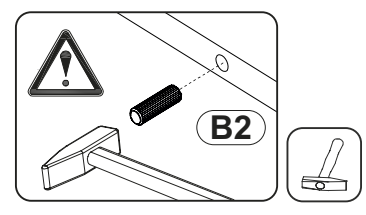
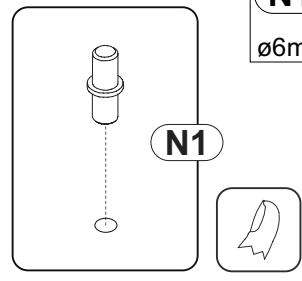
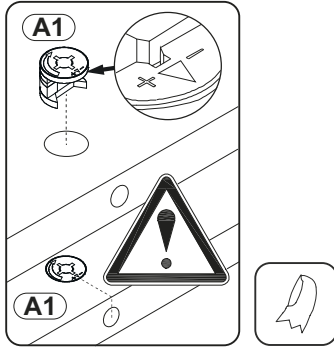
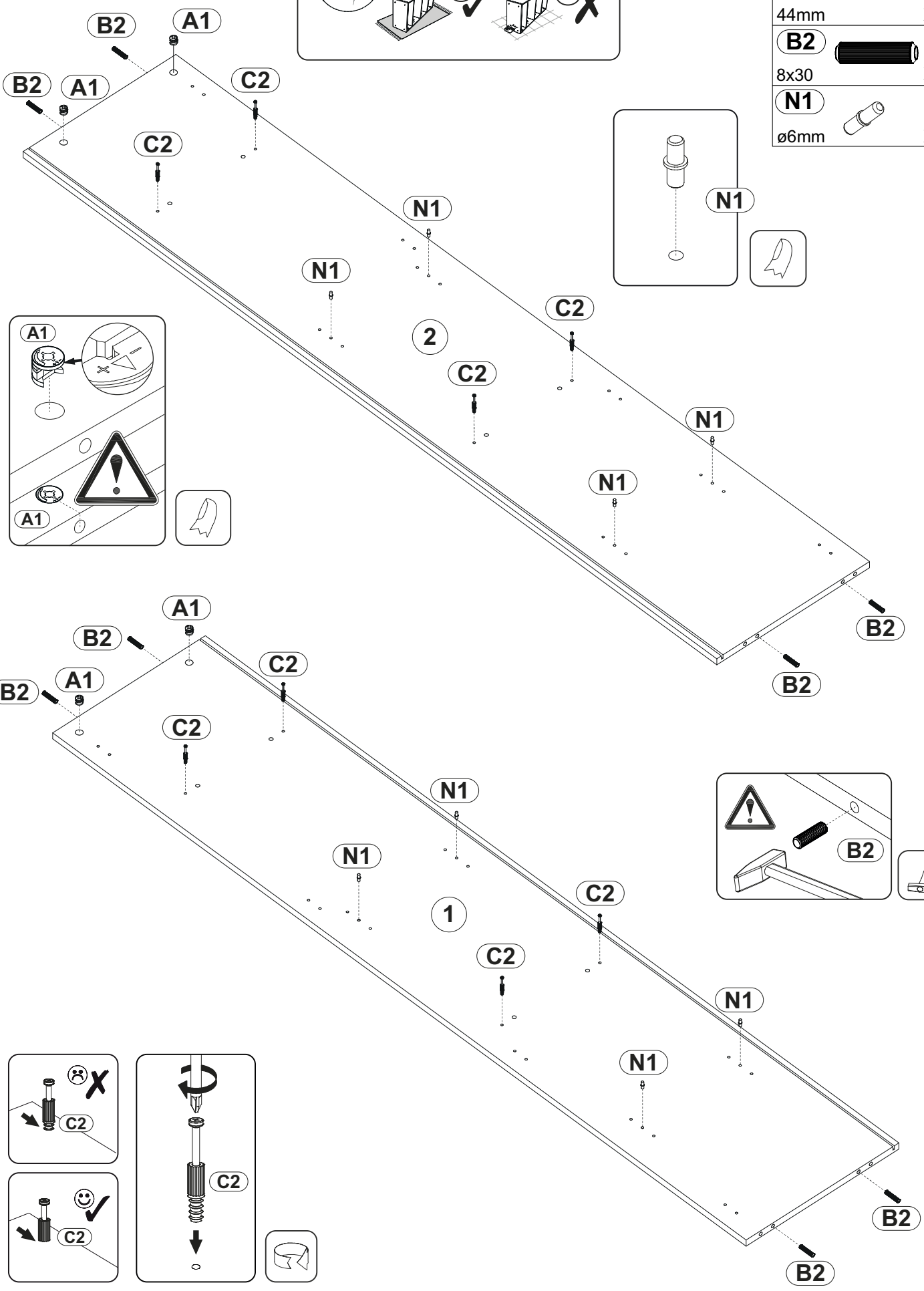

3

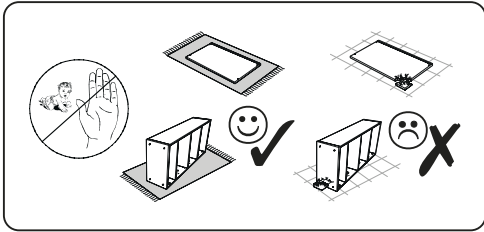

O1
ø18mm  **x8**

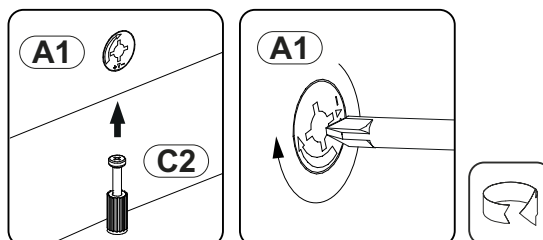
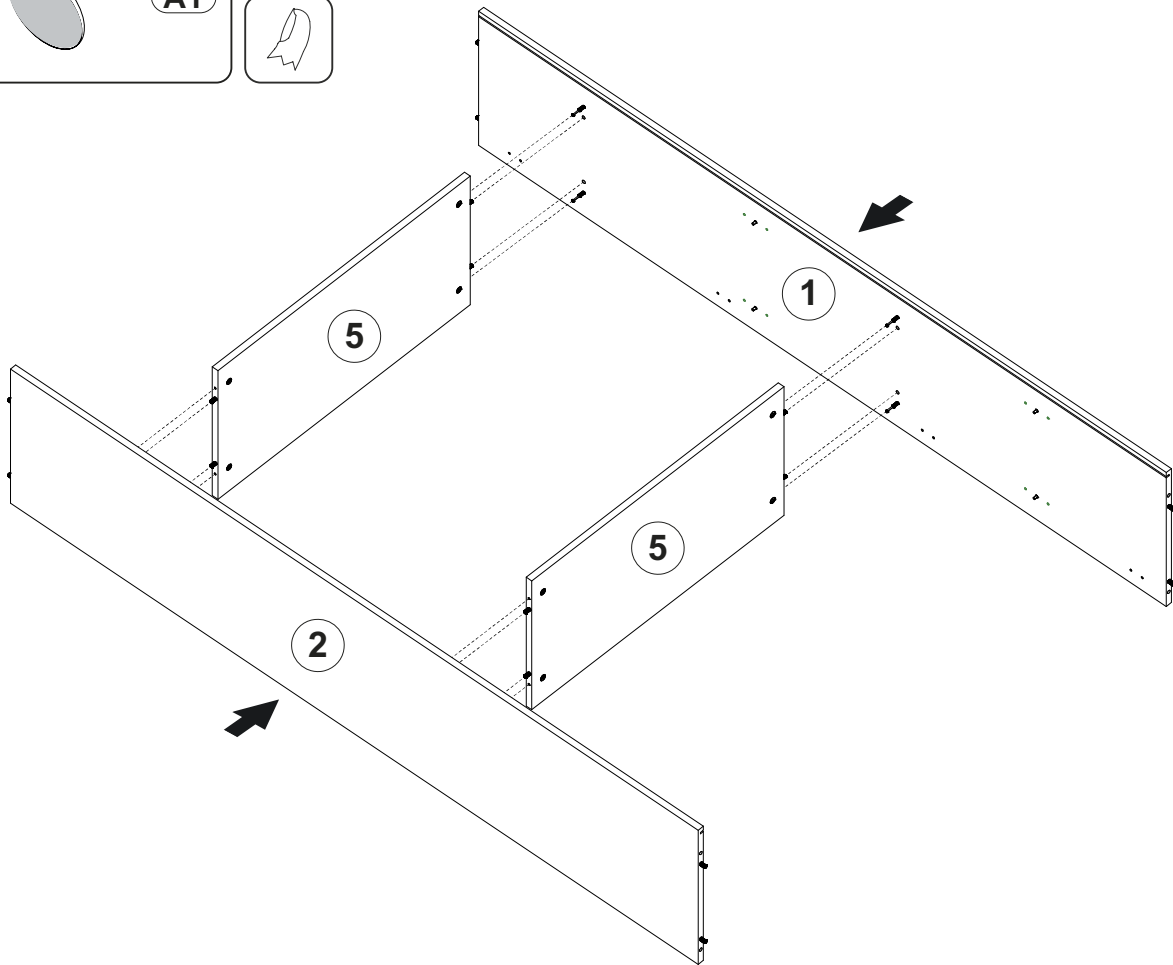
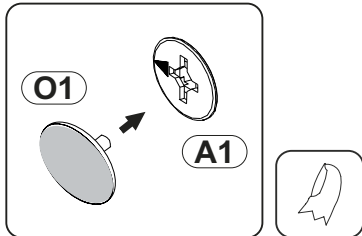

4

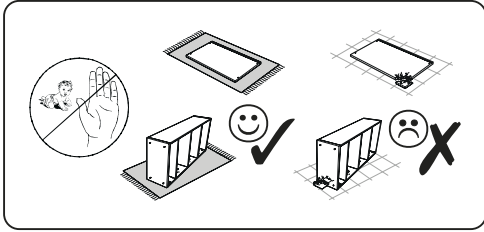

O2
ø18mm  **x4**

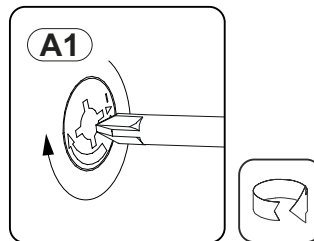
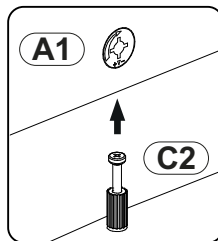
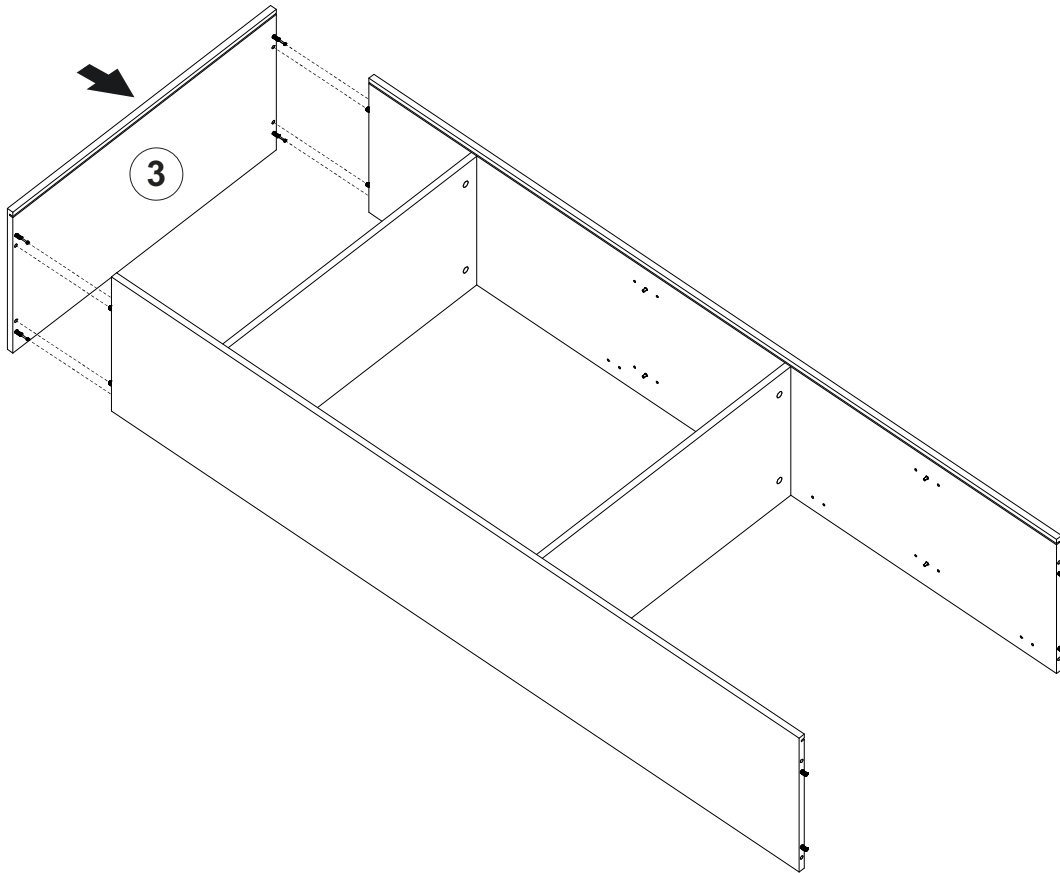
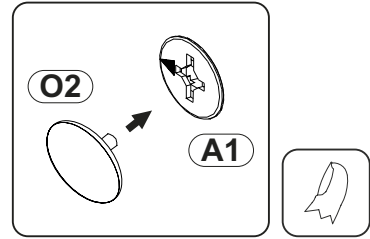

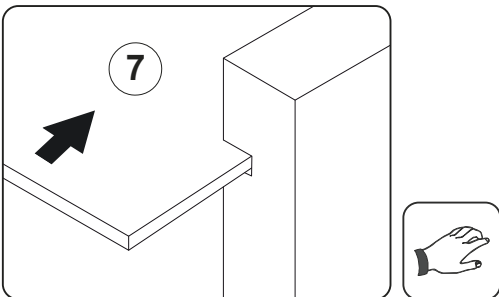
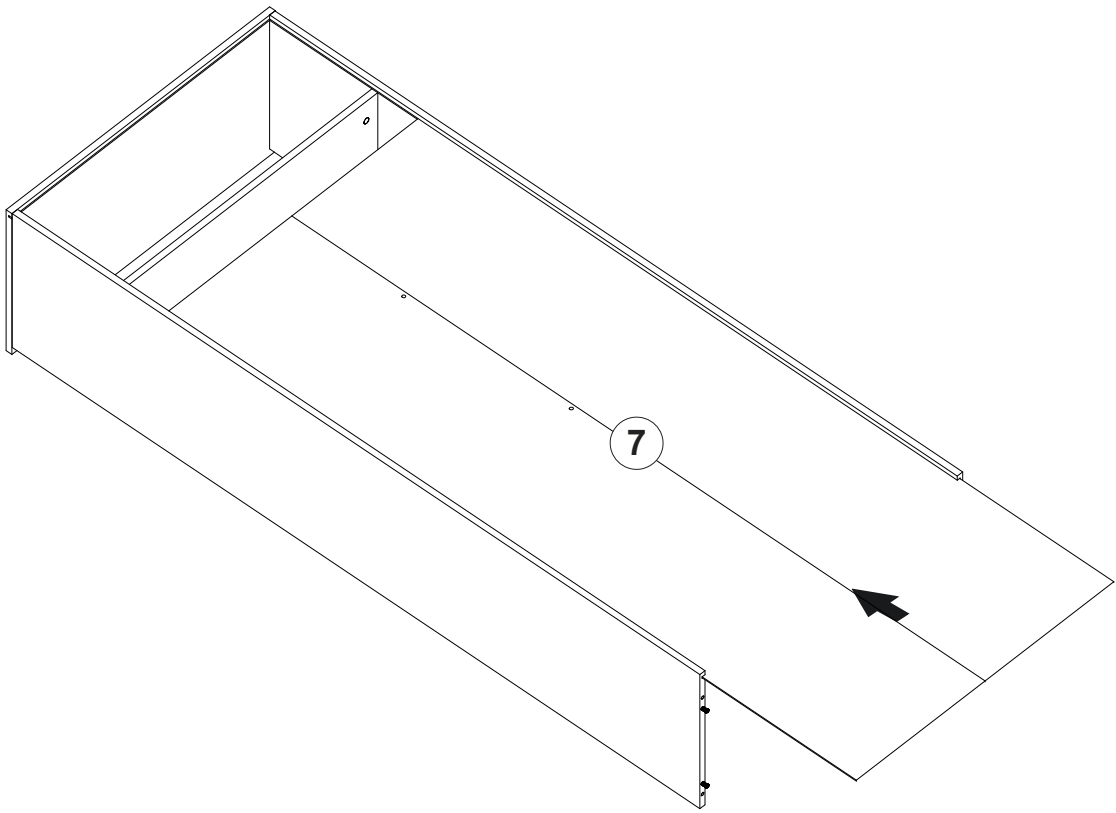
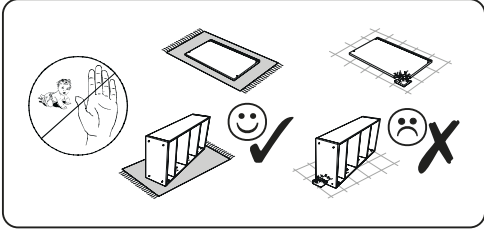

5

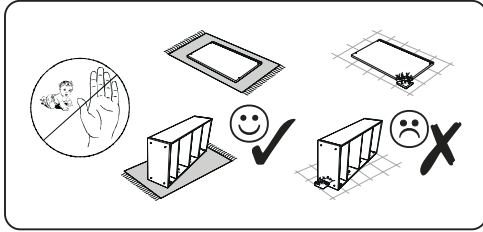

6

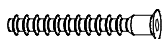



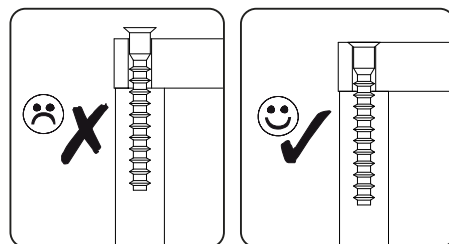
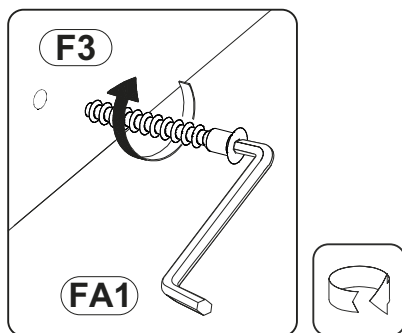
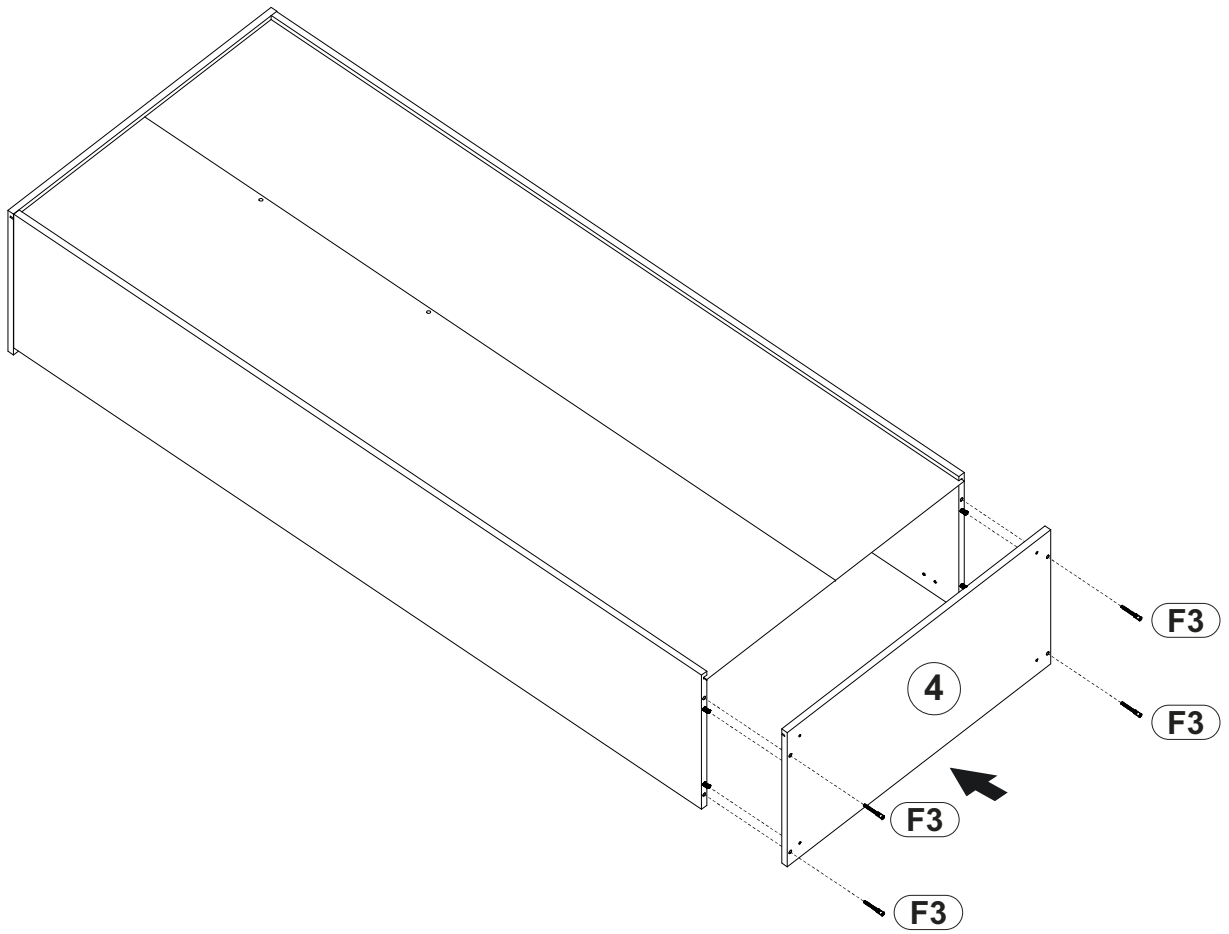

F3		x4
6,3x50		
FA1		x1
4mm		

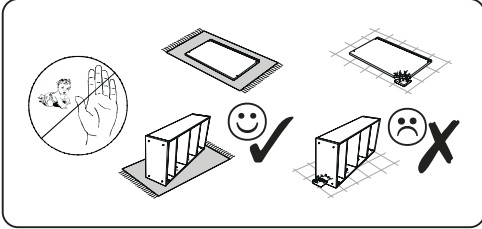

7



- P18**  **x4**
45x20
- D25**  **x4**
4x25
- M1**  **x16**
10x10x15
- DA21**  **x4**
4,2x16

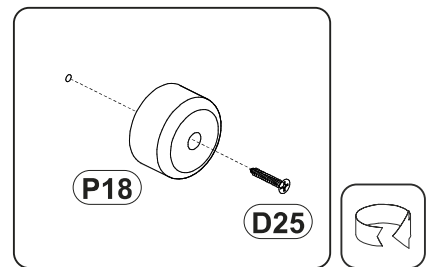
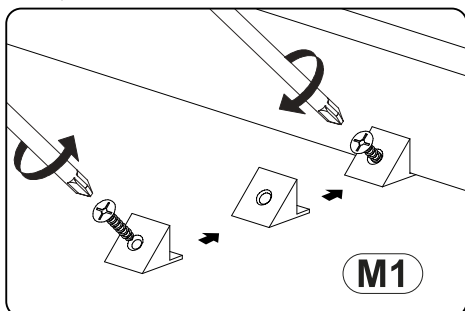
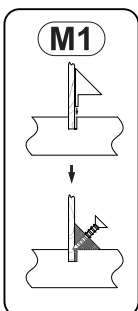
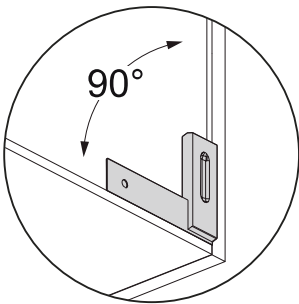
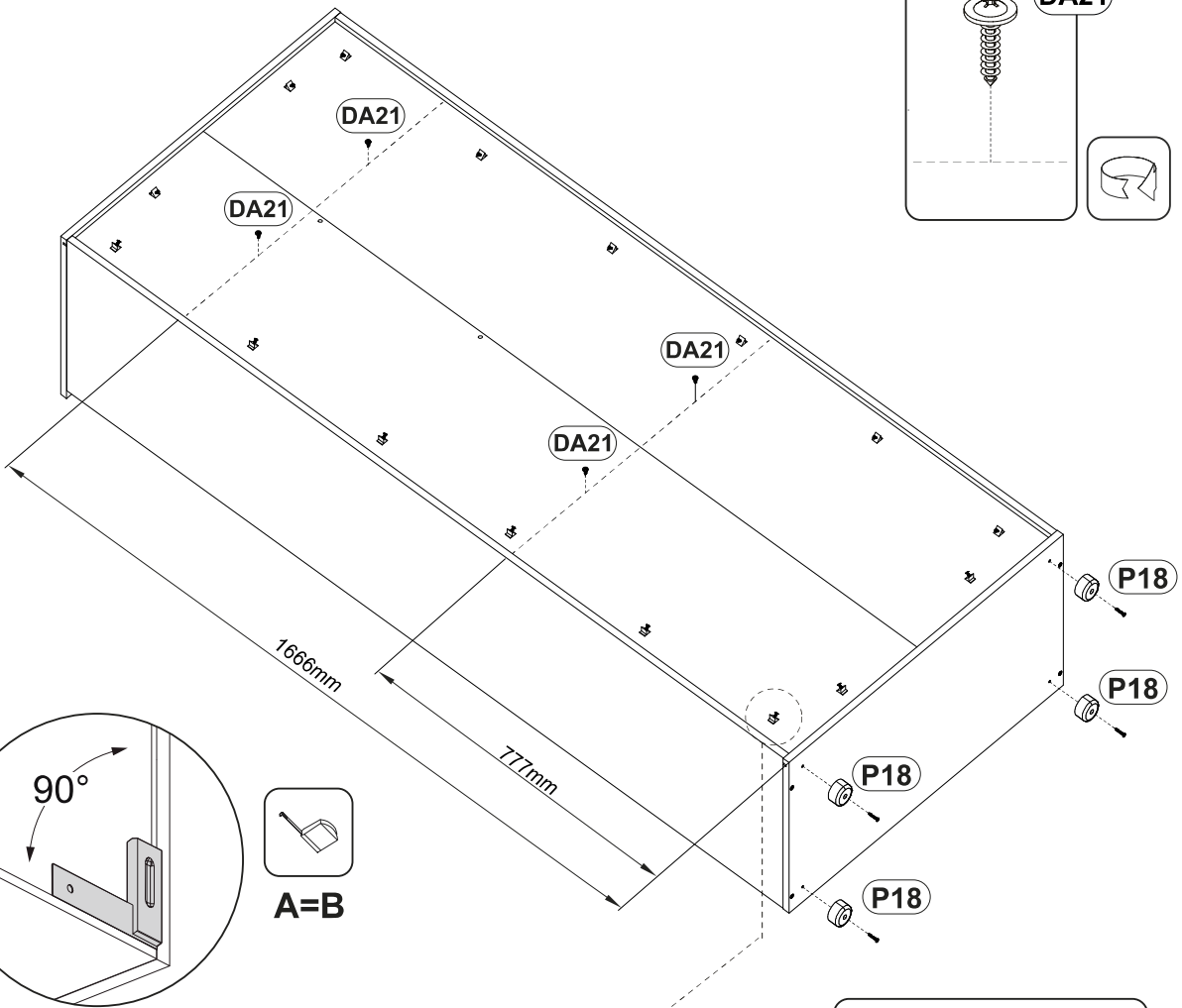
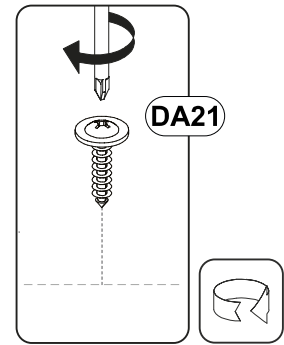
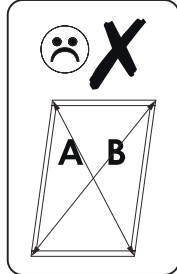
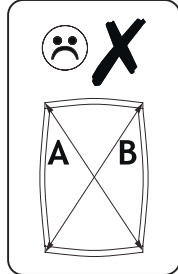
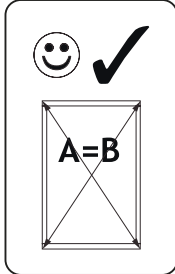



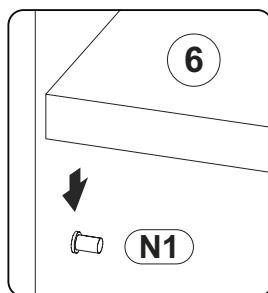
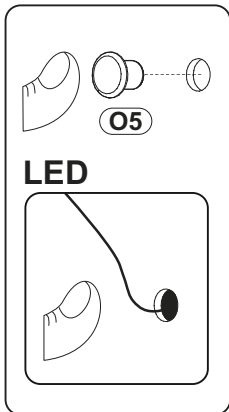
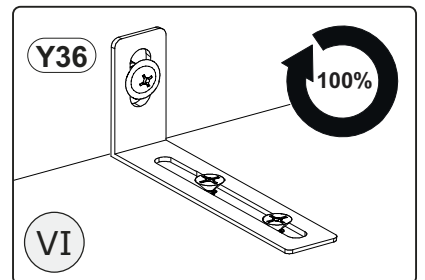
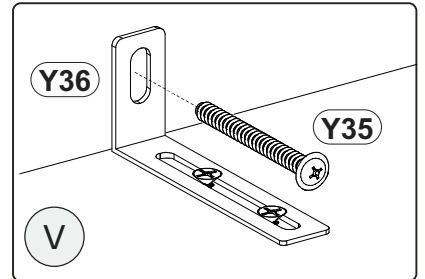
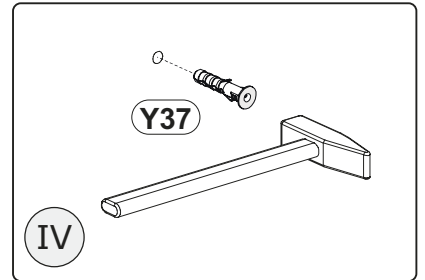
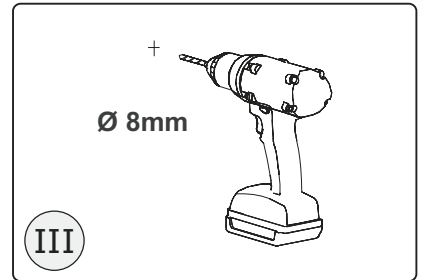
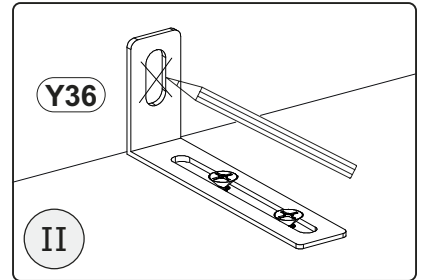
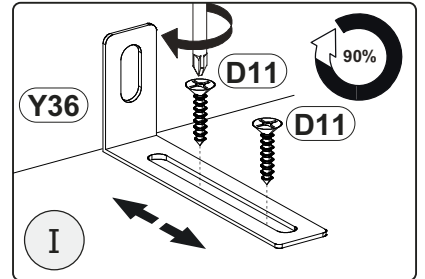
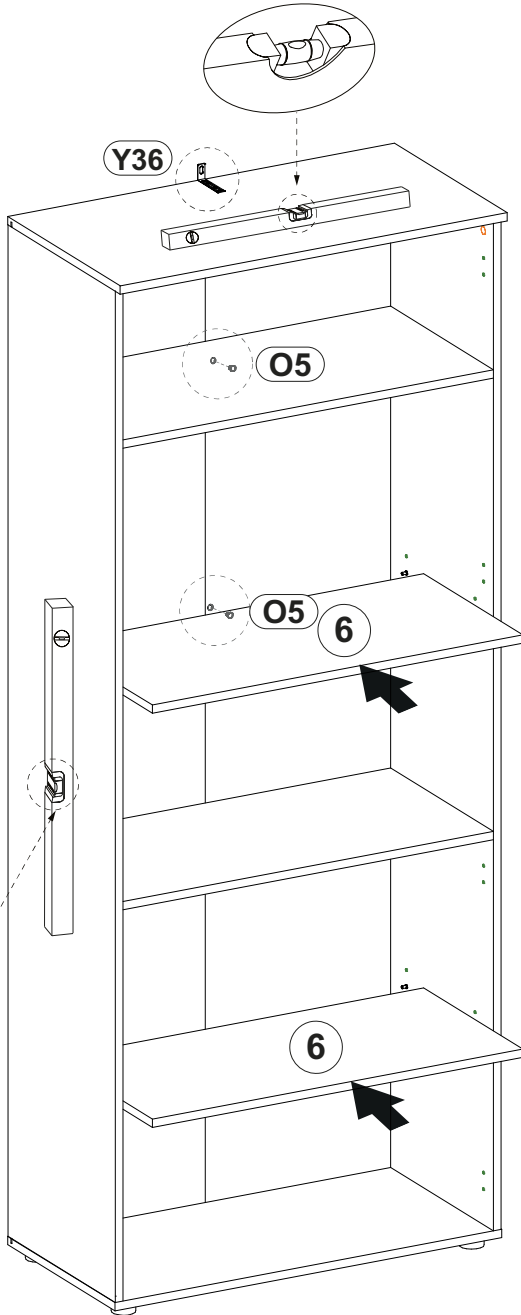
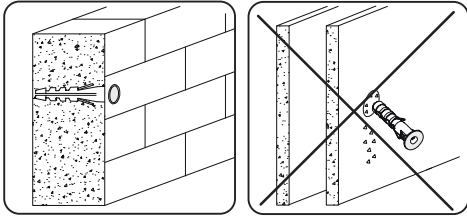

O5 Ø8 x2		Y36 75x32x15 x1		Y37 8x50 x1	
D11 3,5x16 x2		Y35 4,2x65 x1			

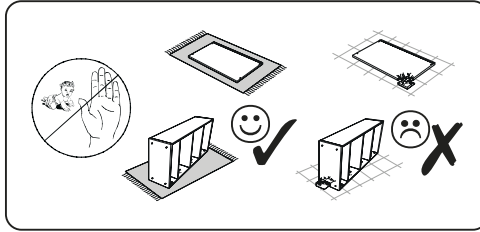

9



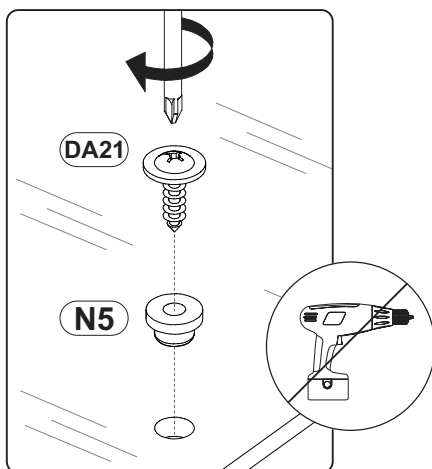
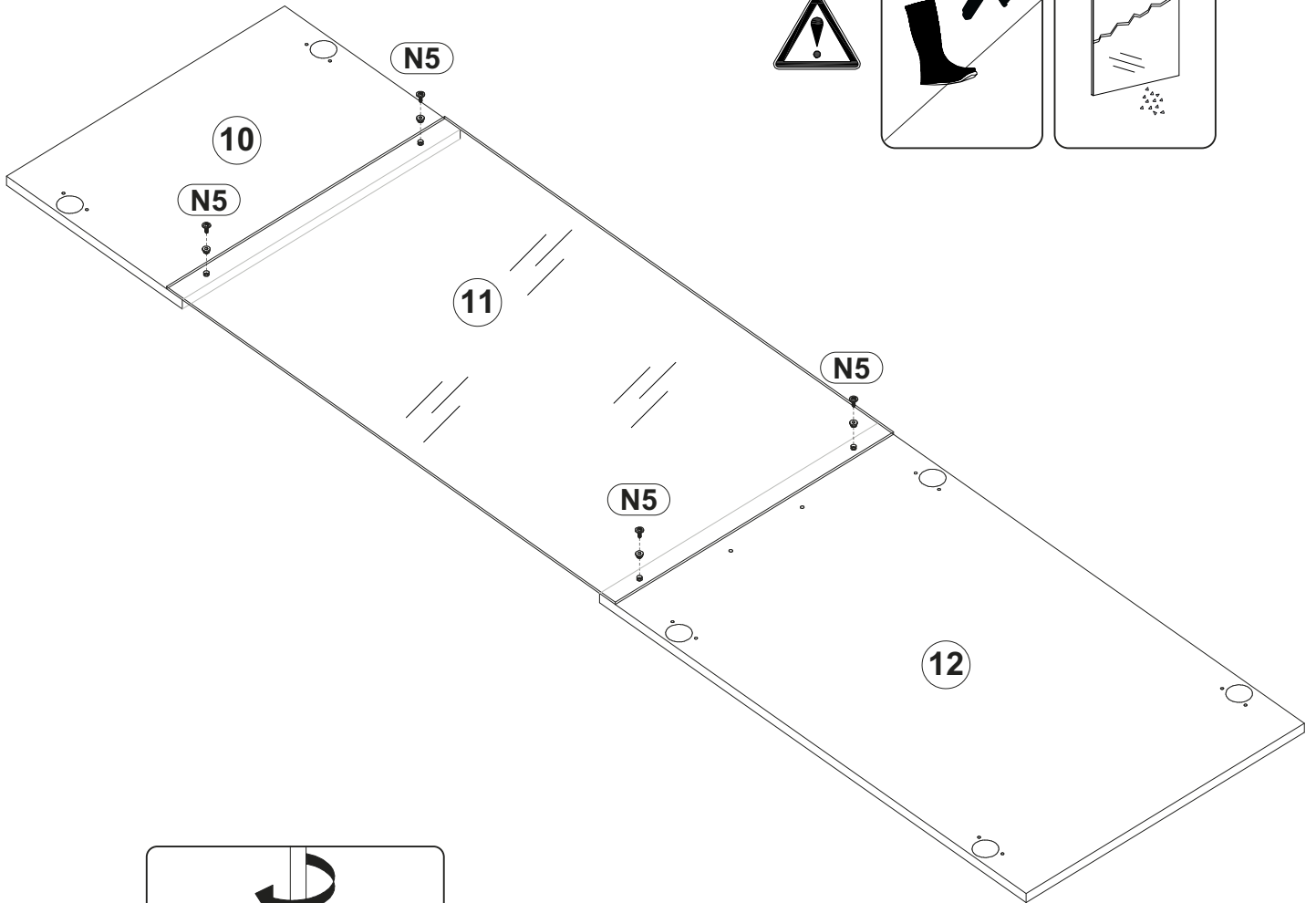
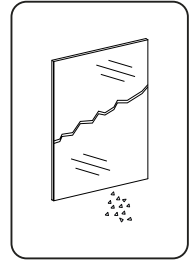
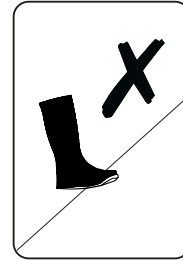

N5		x4
10x6x10		
DA21		x4
4,2x16		

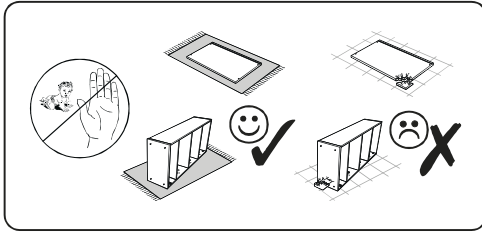
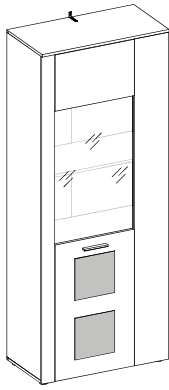

10

L

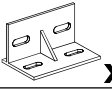

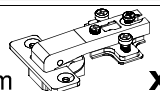
- T1**  **x4**
30x35x55
- DA21**  **x8**
4,2x16
- K9**  **x3**
ø35mm

I

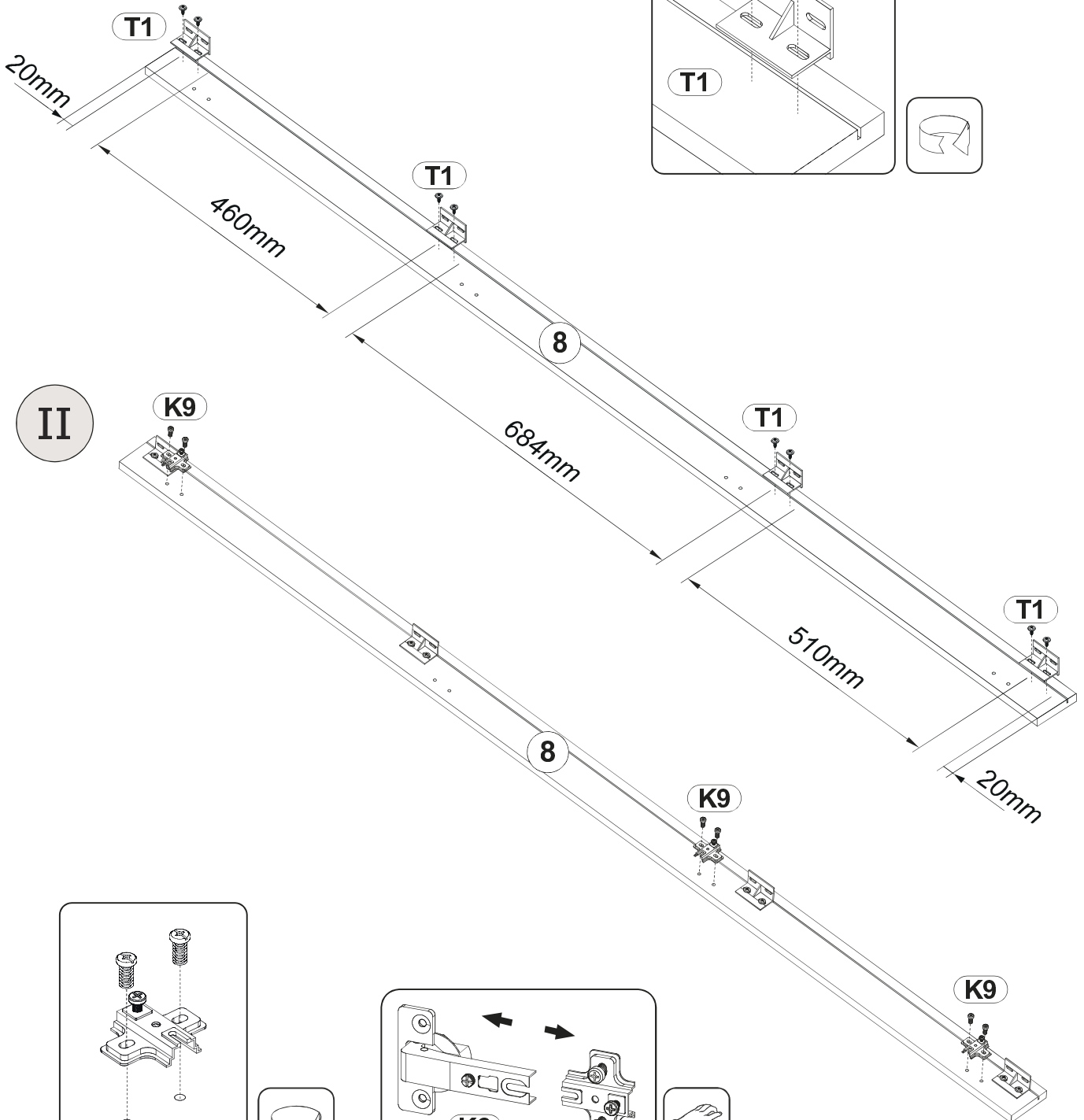
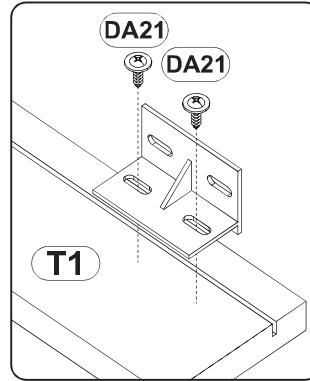

II

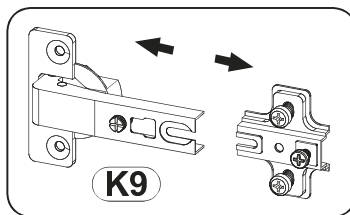
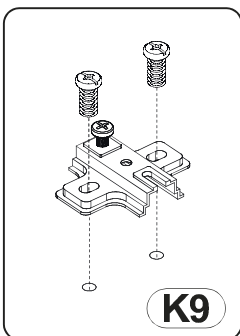

11

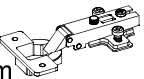

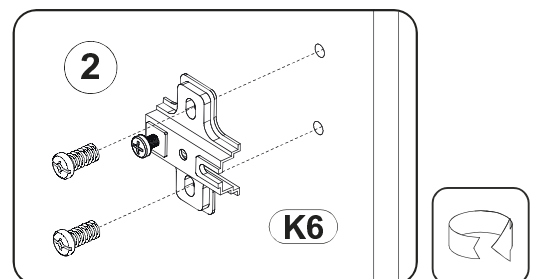
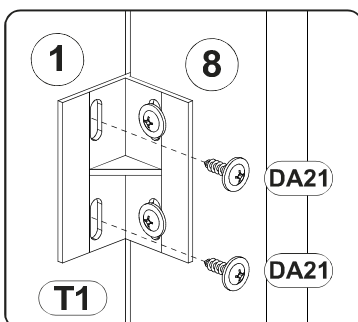
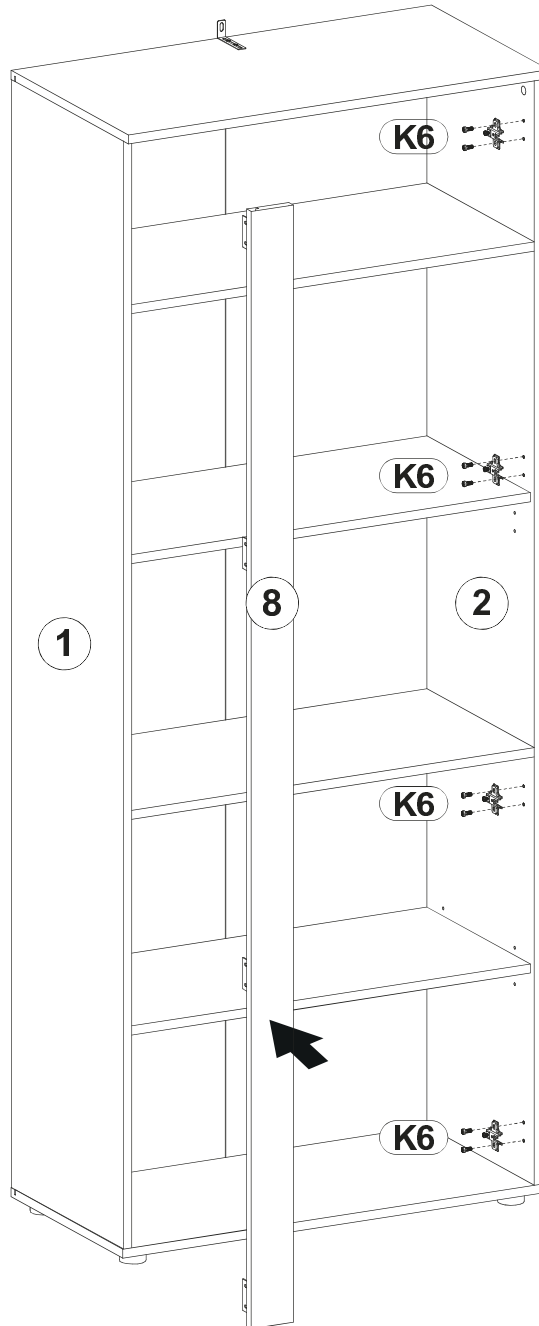
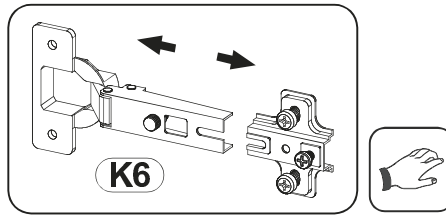
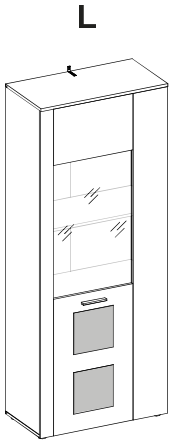

DA21  **x8**
4,2x16
K6  **x4**
ø35mm

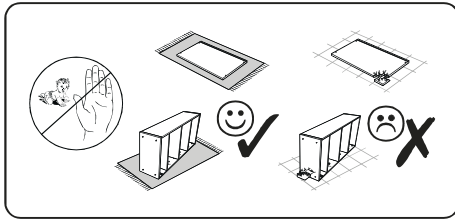

12

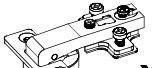
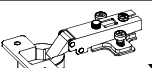
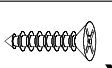
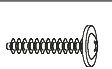
L

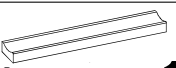

- K9**  **x3**
ø35mm
- K6**  **x4**
ø35mm
- D11**  **x14**
3,5x16
- DB2**  **x2**
4x25
- R5**  **x6**
ø6mm
- J65**  **x1**
128/148
- R6**  **x3**

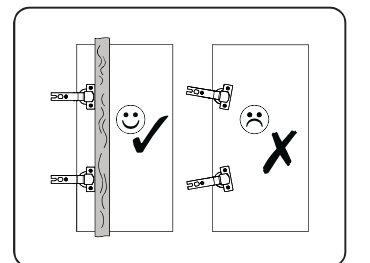
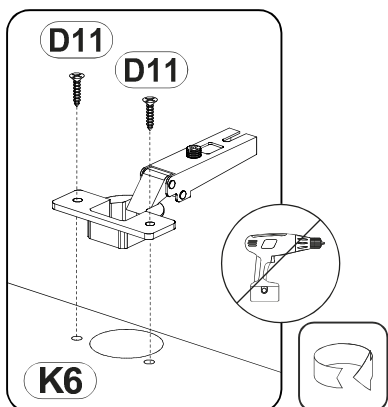
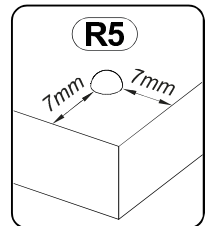
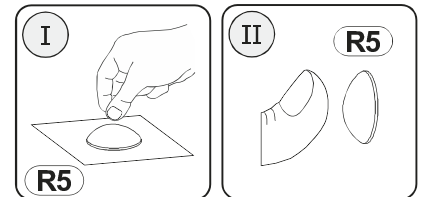
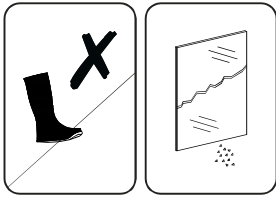
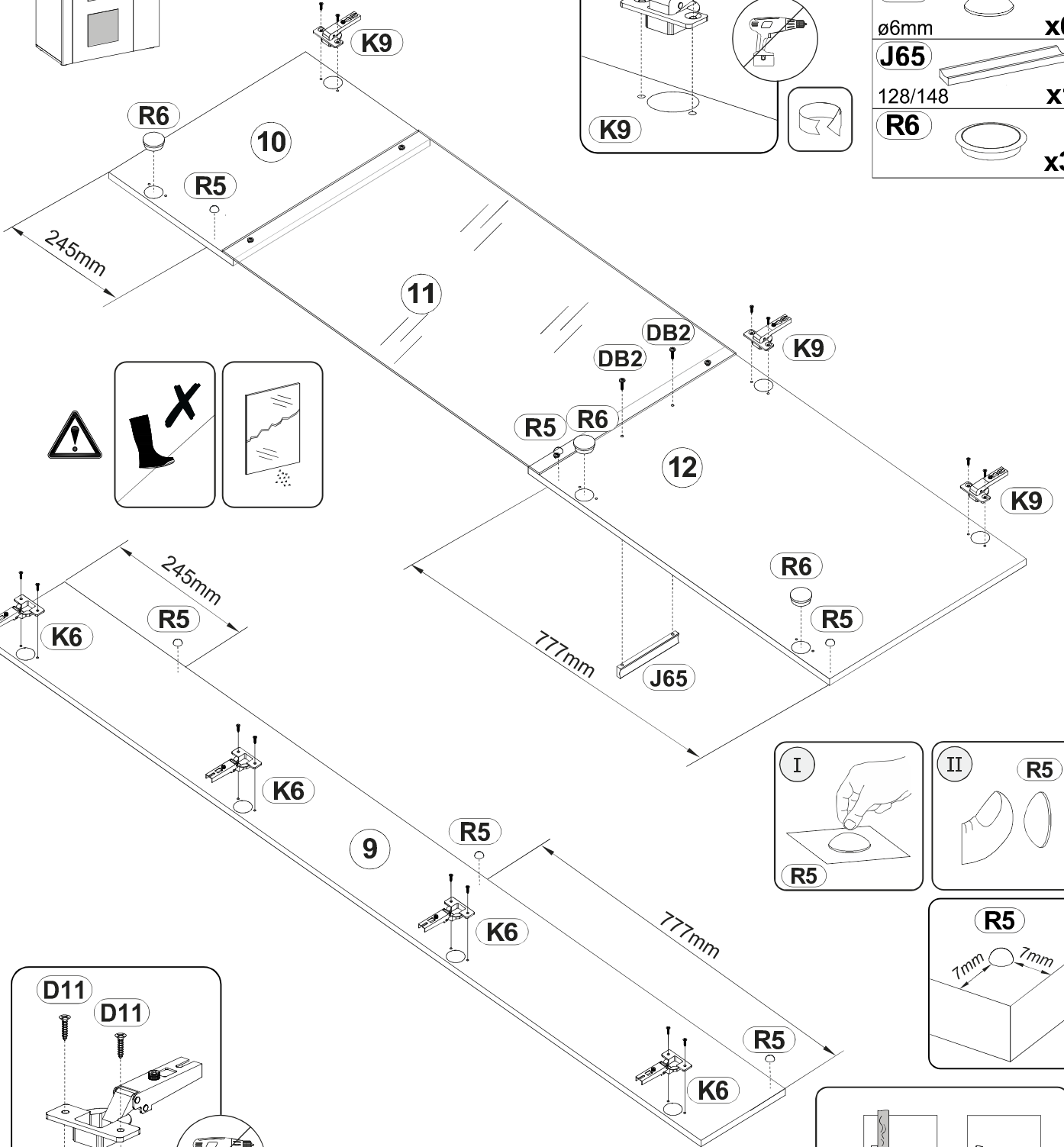
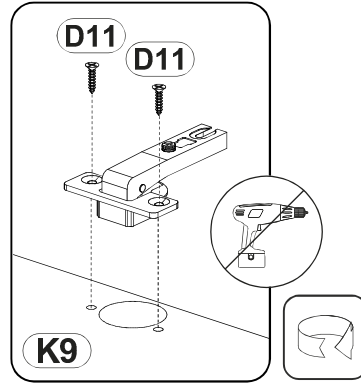

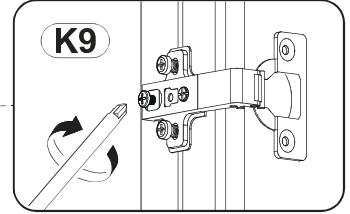
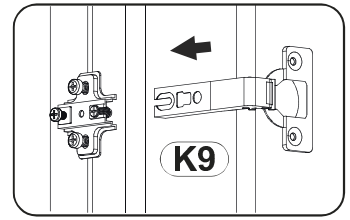
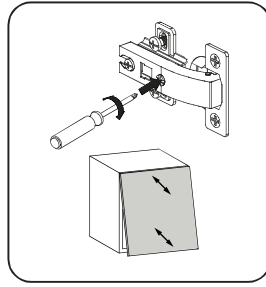
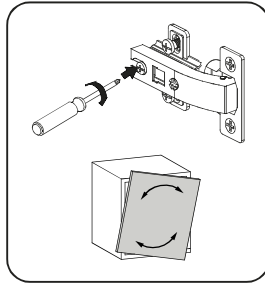
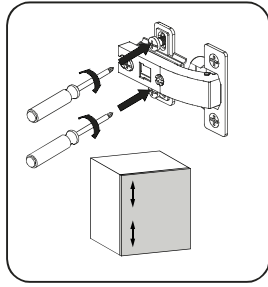

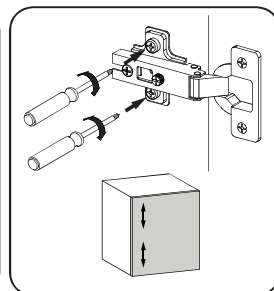
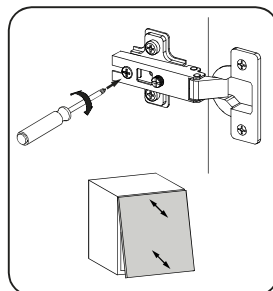
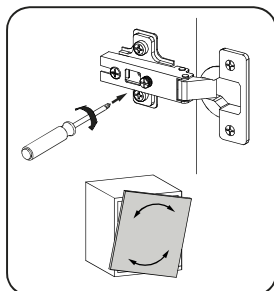
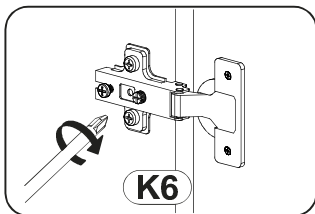
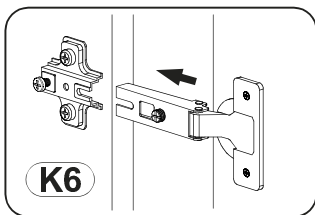
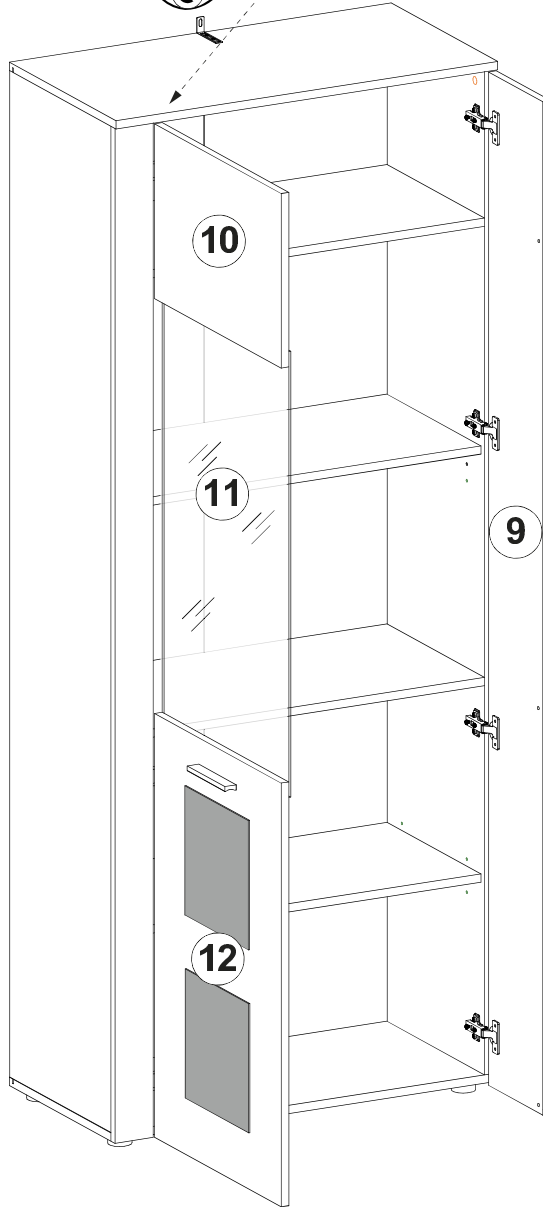
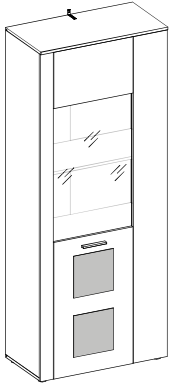

L

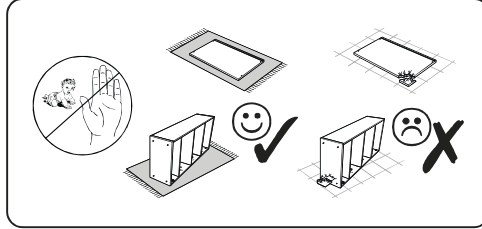
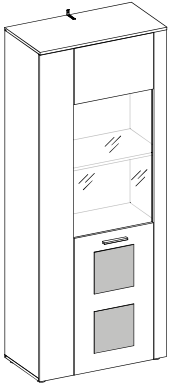

R

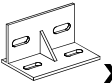

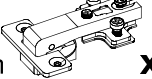
- T1**  30x35x55 **x4**
- DA21**  4,2x16 **x8**
- K9**  ø35mm **x3**

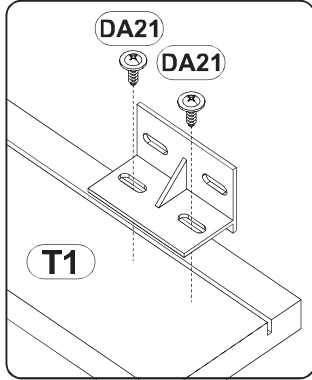

I

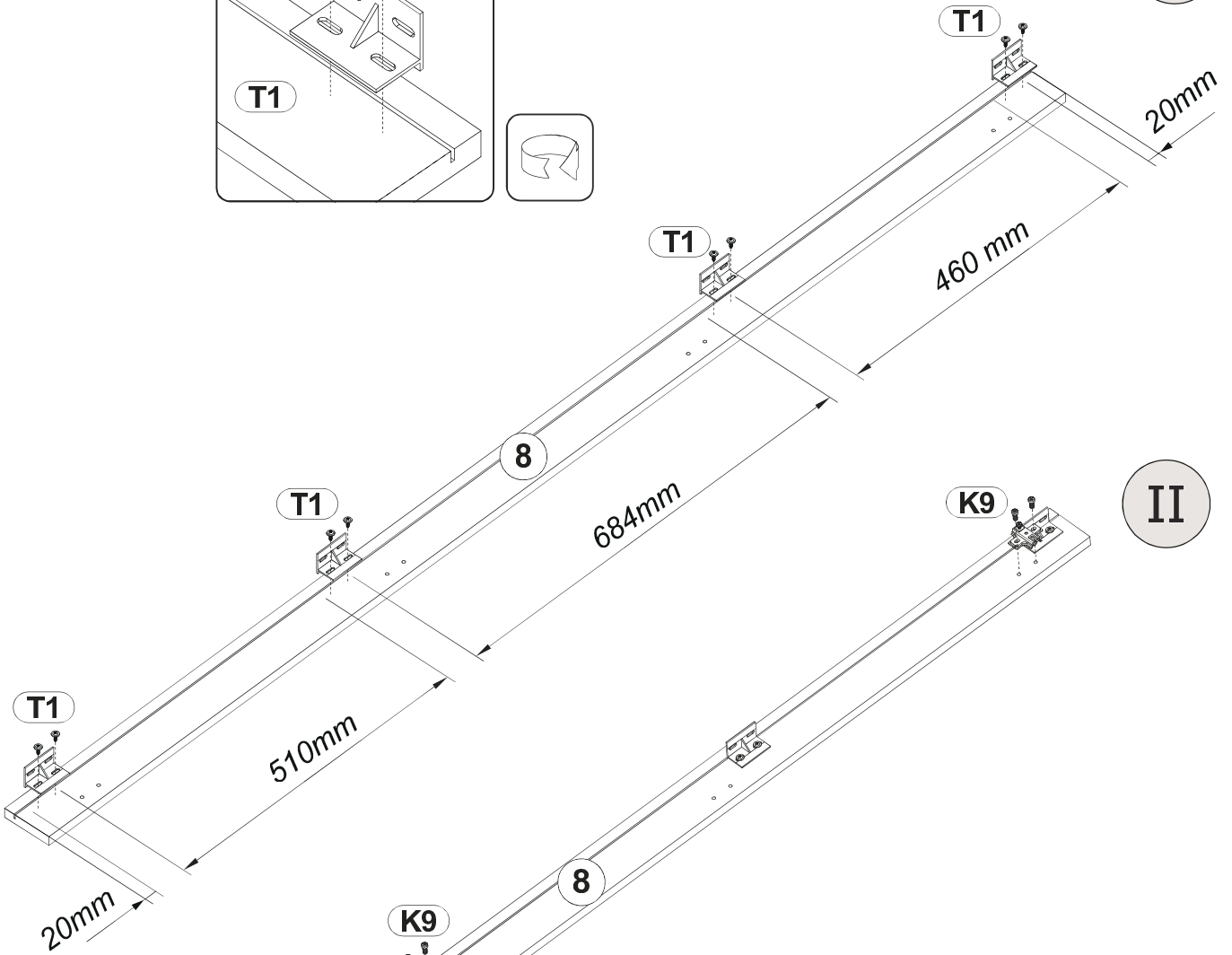

II

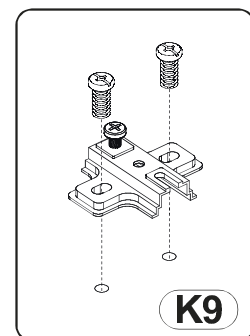
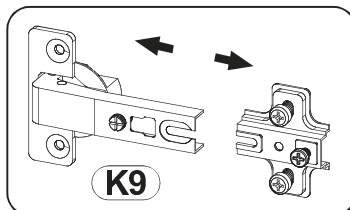

15

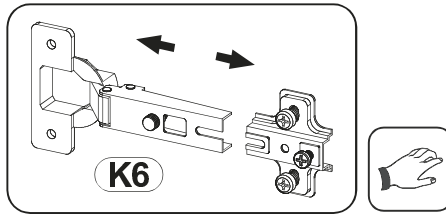

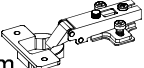
- DA21 4,2x16  x8
- K6  x4
- ø35mm

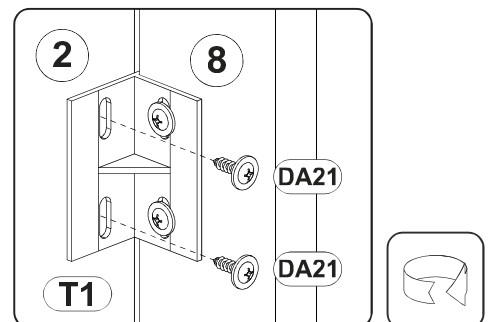
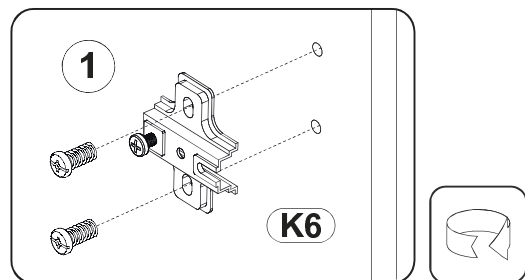
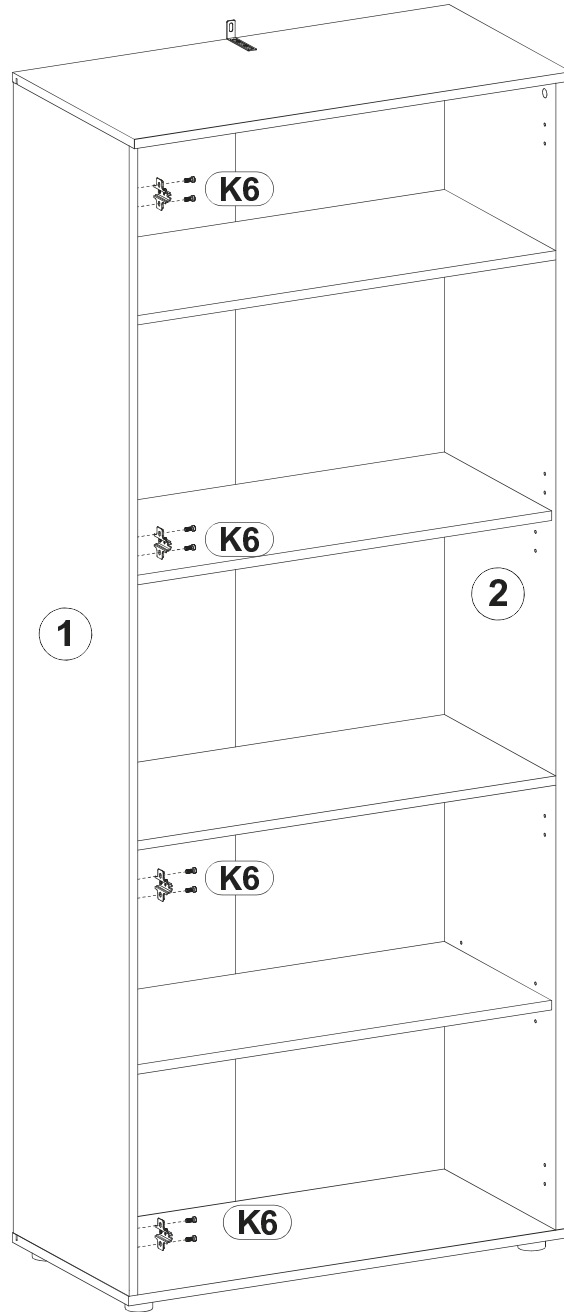

16

R

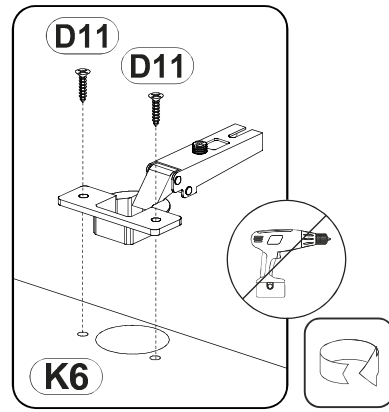
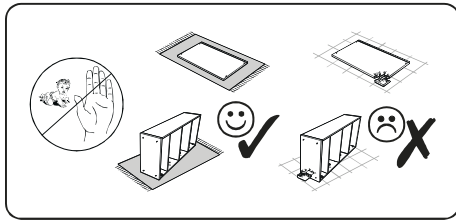
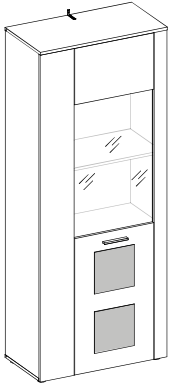

K9		x3
ø35mm		
K6		x4
ø35mm		
D11		x14
3,5x16		
DB2		x2
4x25		
R5		x6
ø6mm		
J65		x1
128/148		
R6		x3

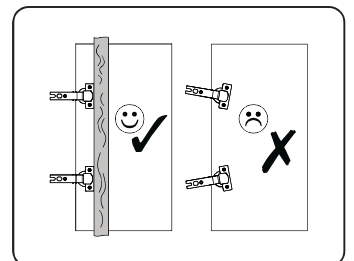
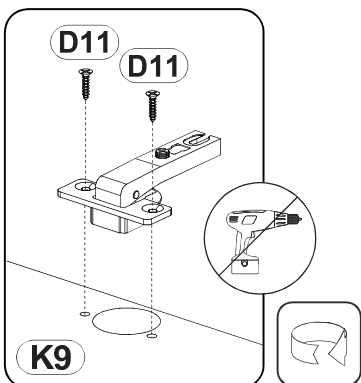
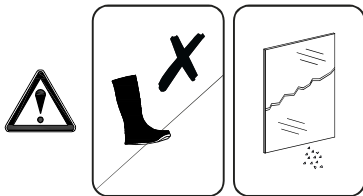
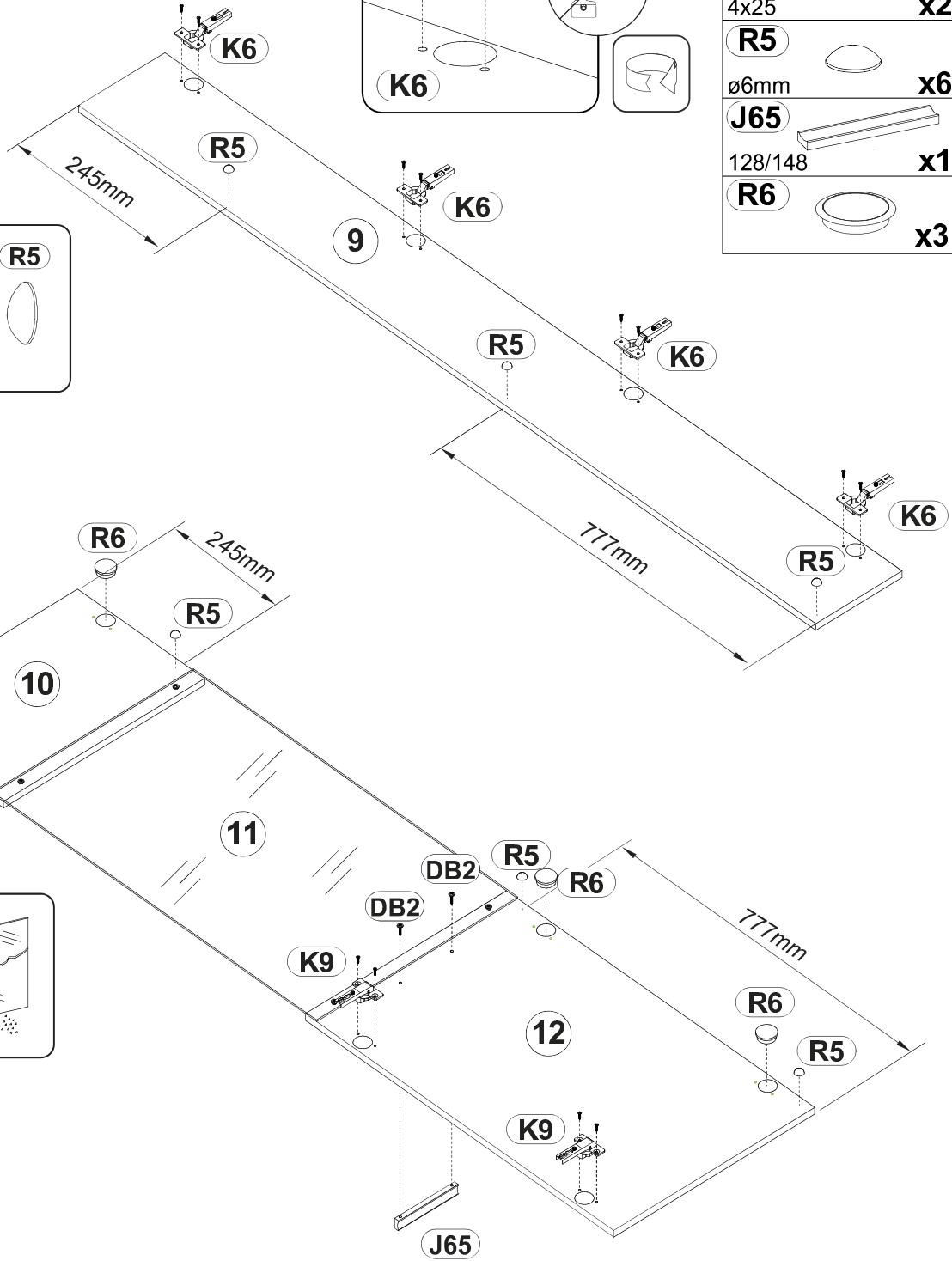
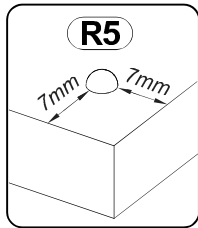
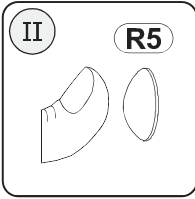
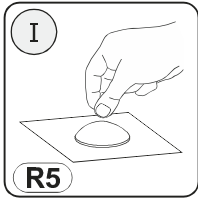

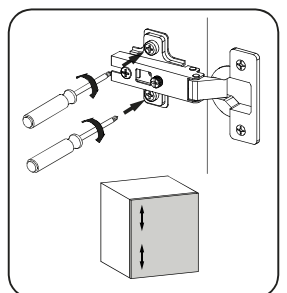
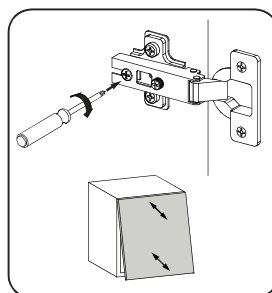
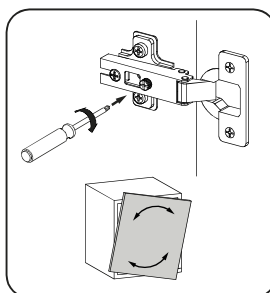
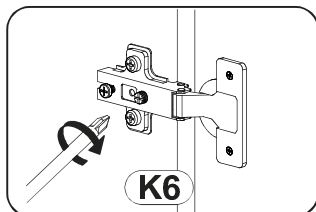
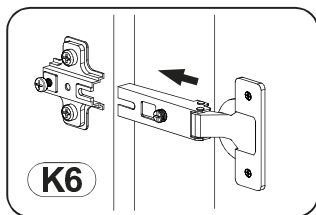
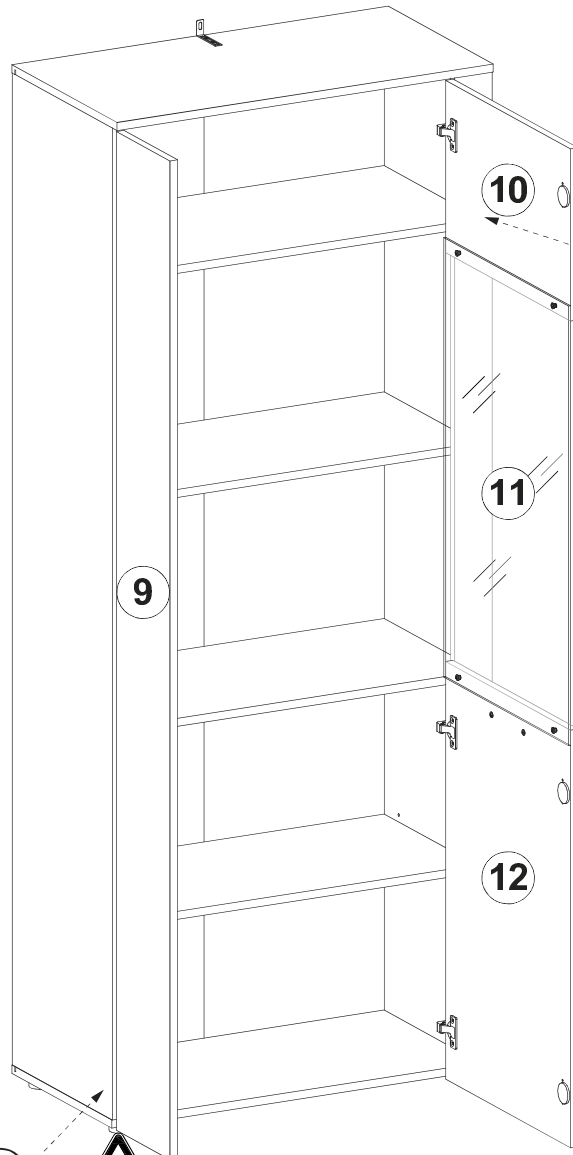
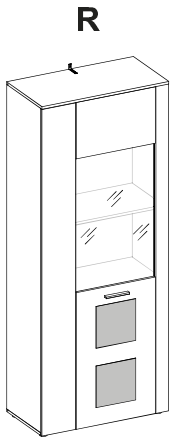
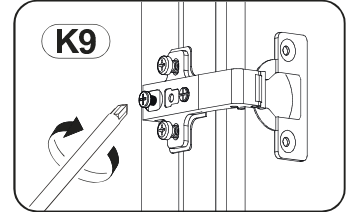
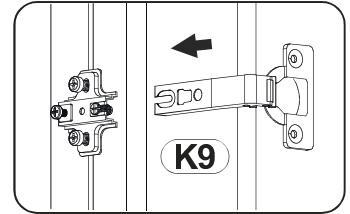
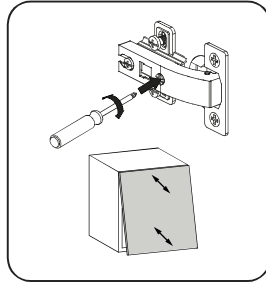
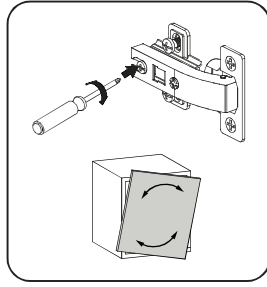
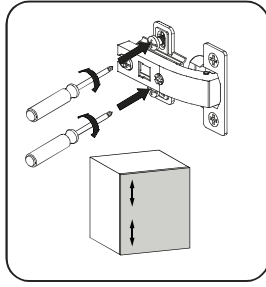



L

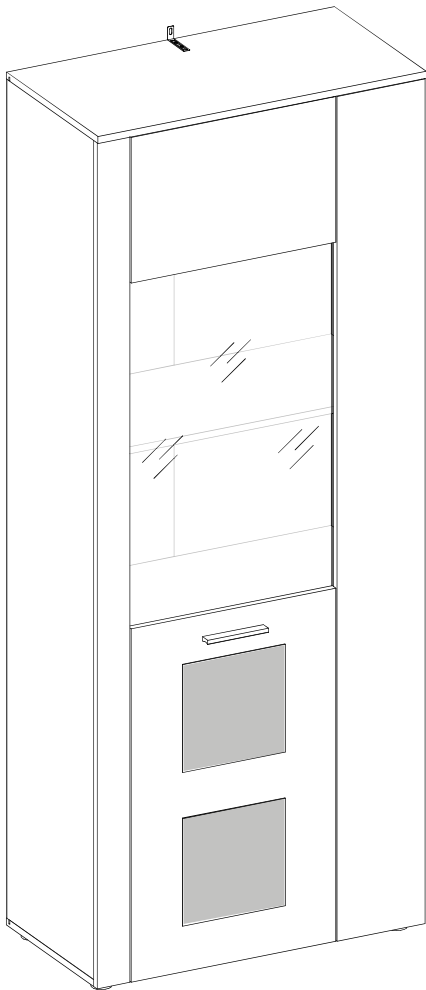

R

