

VISBY V
8100/2503
2501/8300

- | | | | |
|-----------|--|-----------|---|
| D | MONTAGEANLEITUNG
BEDIENUNGSANLEITUNG | GB | ASSEMBLY INSTRUCTIONS
INSTRUCTION MANUAL |
| NL | HANDLEIDING VOOR DE MONTAGE
GEBRUIKSAANWIJZING | PL | INSTRUKCJA MONTAŻU
INSTRUKCJA OBSŁUGI |
| TR | MONTAJ TALIMATI
KULLANIM KLAVUZU | RU | ИНСТРУКЦИЯ ПО МОНТАЖУ
ИНСТРУКЦИЯ ПО ЭКСПЛУАТАЦИИ |
| RO | INSTRUCȚIUNI DE INSTALARE
INSTRUCȚIUNI DE UTILIZARE | IT | ISTRUZIONI DI MONTAGGIO
MANUALE DI ISTRUZIONI |
| FR | NOTICE DE MONTAGE
MANUEL INSTRUCTIONS | SK | MONTÁŽNY NÁVOD
NÁVOD NA POUŽITIE |
| HU | KÖZGYŰLÉS UTASÍTÁSOK
KEZELÉSI UTASÍTÁS | CZ | MONTÁŽNÍ NÁVOD
NÁVOD K POUŽITÍ |
| SI | NAVODILA ZA MONTAŽO
NAVODILA ZA UPORABO | PT | INSTRUÇÕES DE MONTAGEM
MANUAL DO USUÁRIO |
| ES | INSTRUCCIONES DE MONTAJE
MANUAL DEL USUARIO | HR | UPUTE ZA MONTAŽU
UPUTE ZA UPOTREBU |

B/F

210410

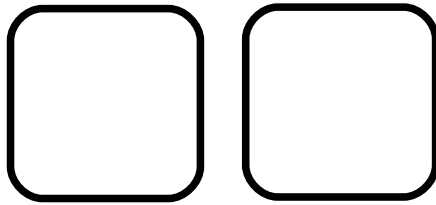

0019

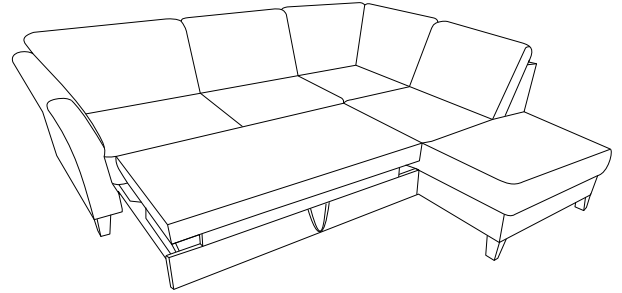
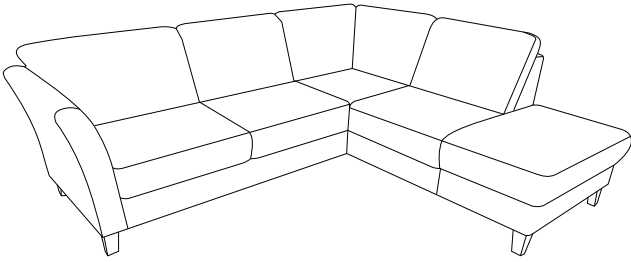

0019

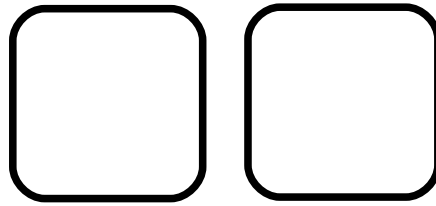

0088

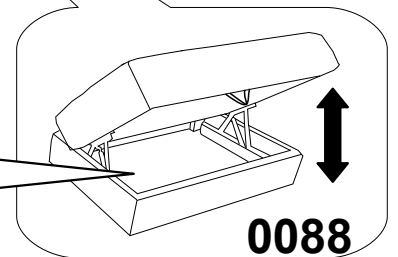
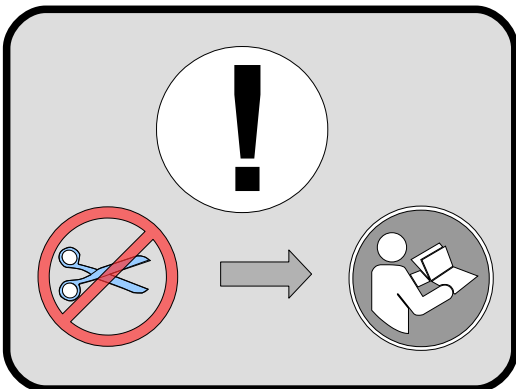
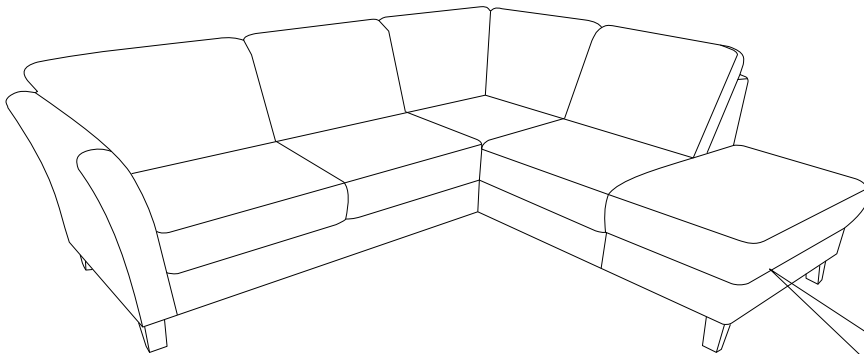

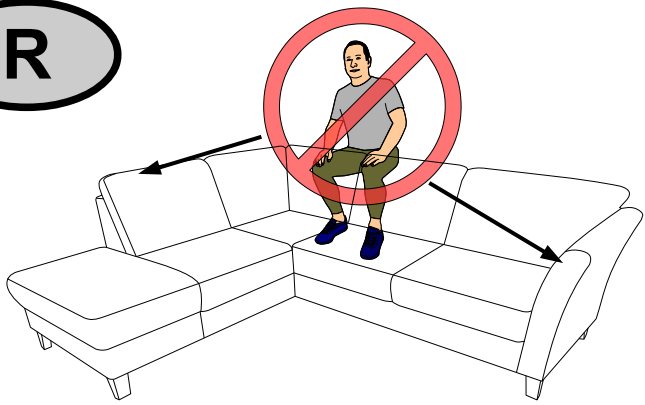

R



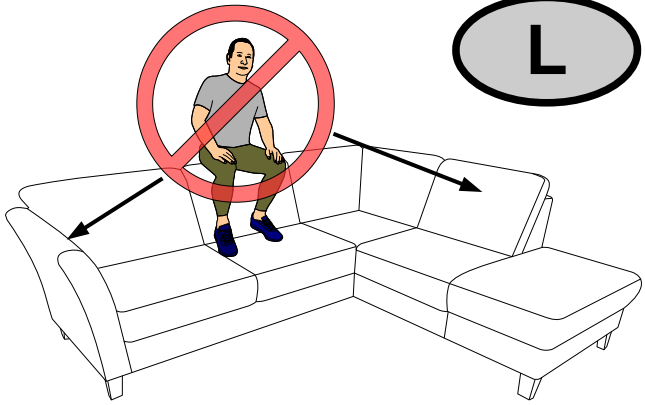





L

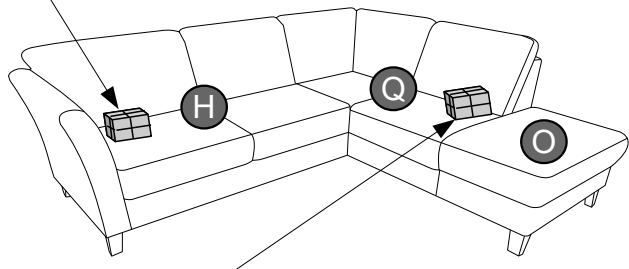
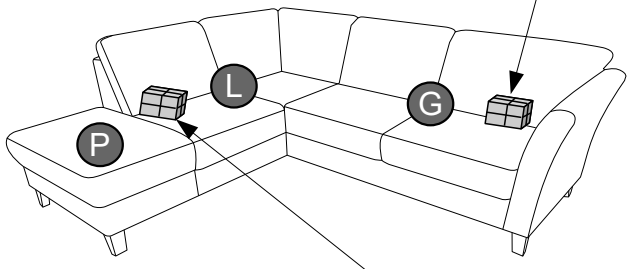

0
10
20
30
40
50
60
70
80
90
100
110
120
130
140
150
160
170
180
190
200

i L-5  X1	S H-120  S₁ X2	q M8*20 [mm]  X2
---	---	--





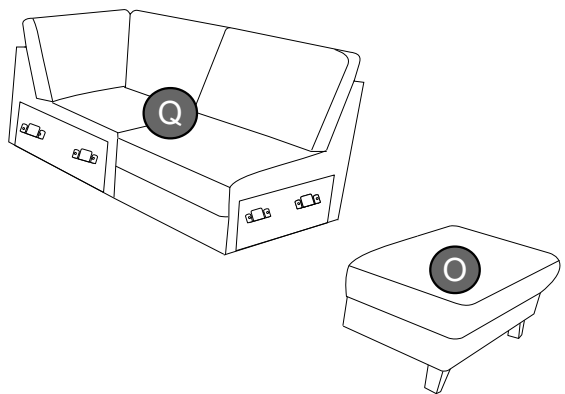
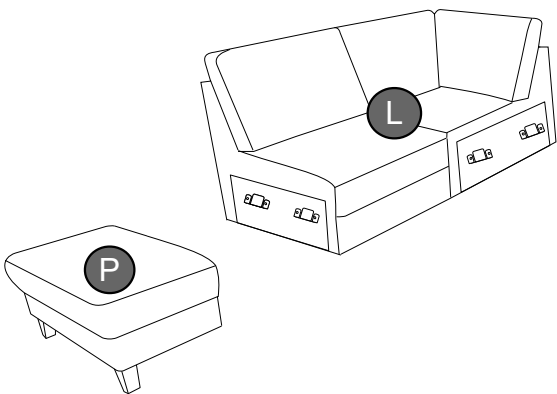
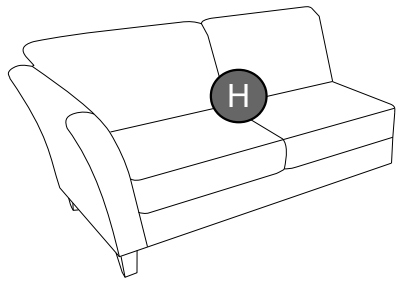
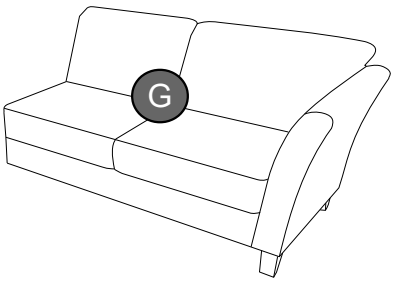

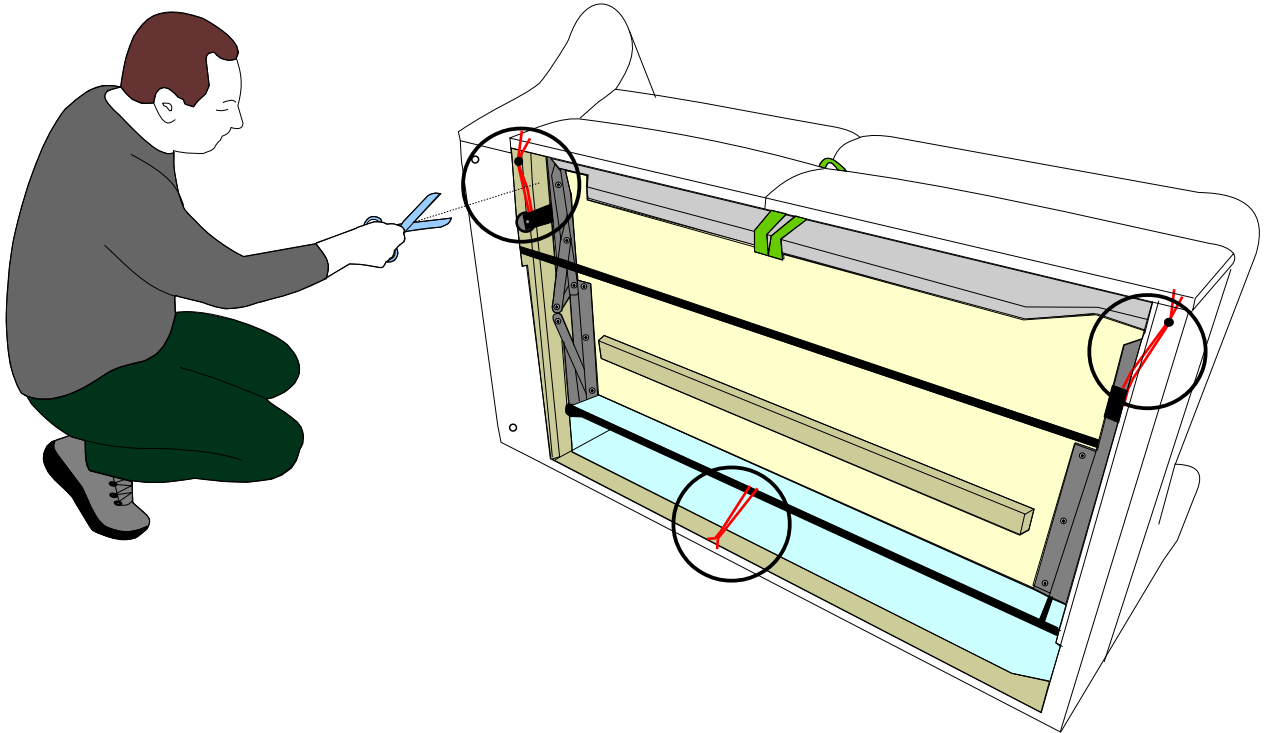
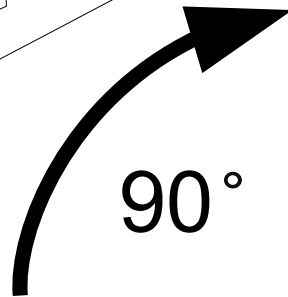
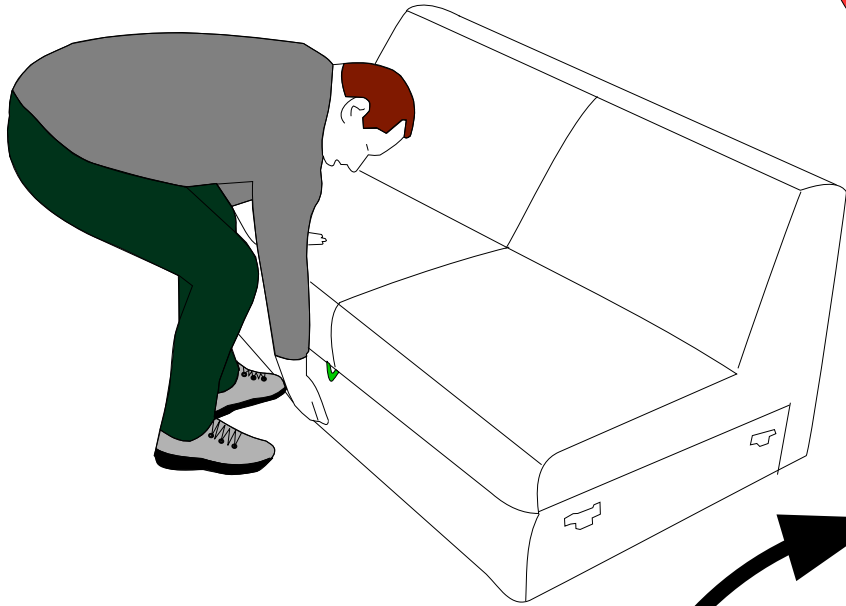

Z H-120  X3	V H-120  X1	i L-5  X1	S H-120  S₁ X3	q M8*20  X3
---	---	---	--	---





0019

Z H-120 	V H-120 	i L-5 	S H-120  S₁ 	q M8*20 
X3	X1	X1	X5	X5

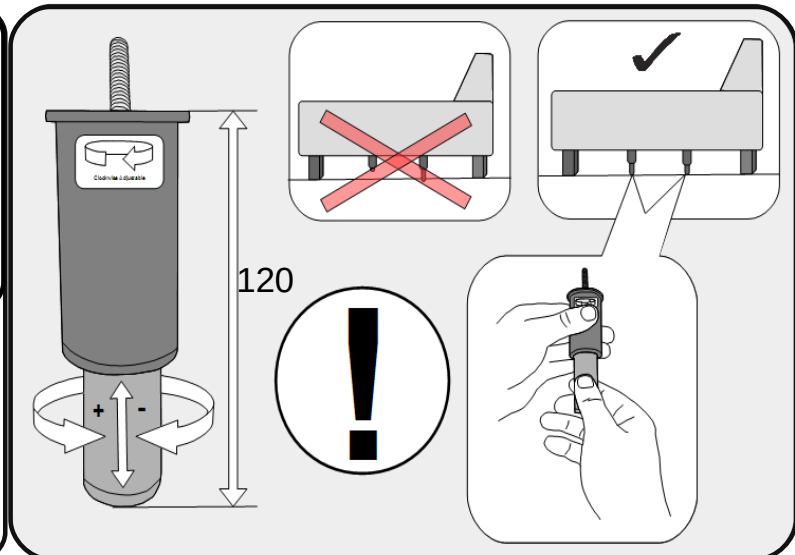
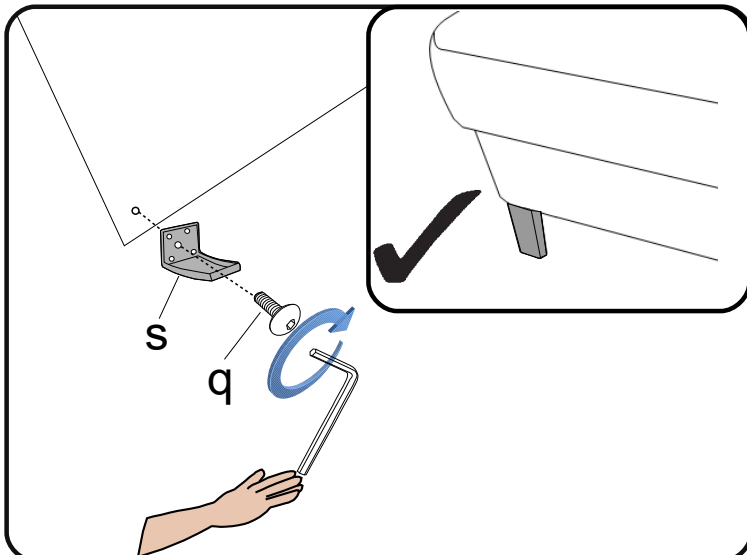
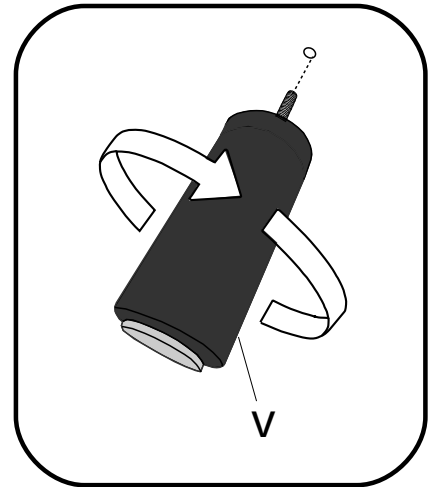
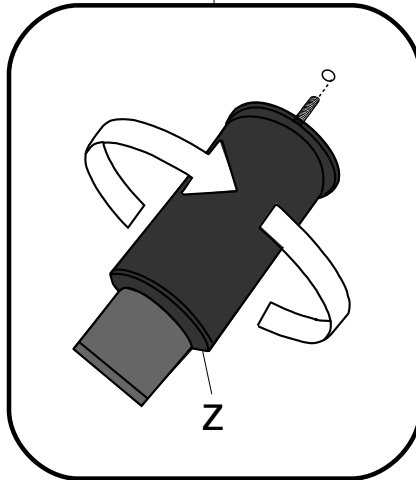
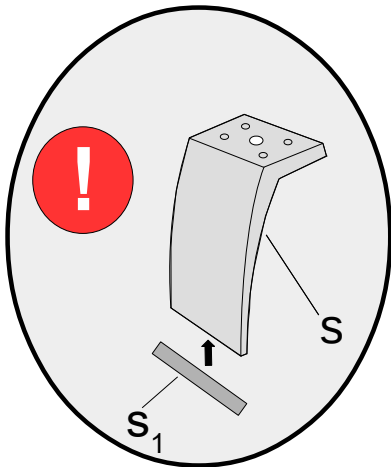
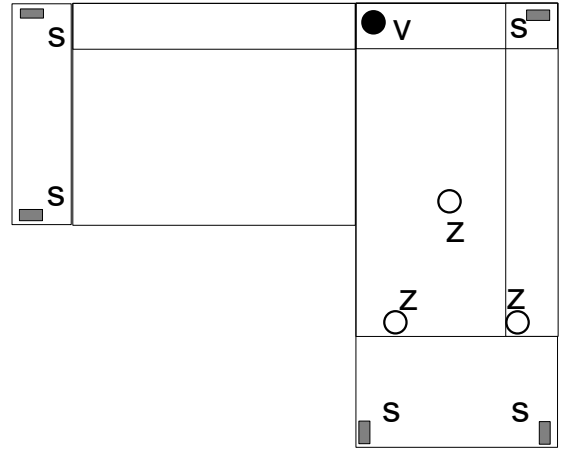
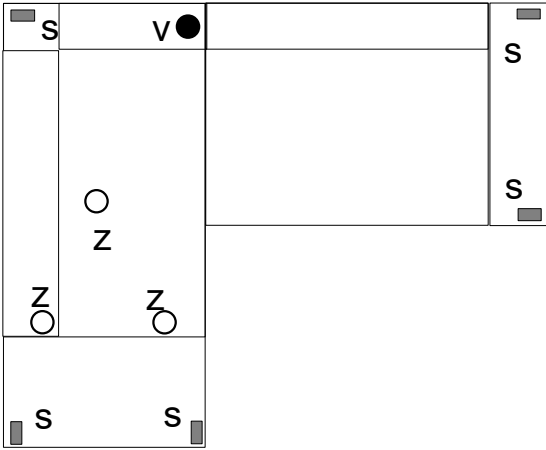
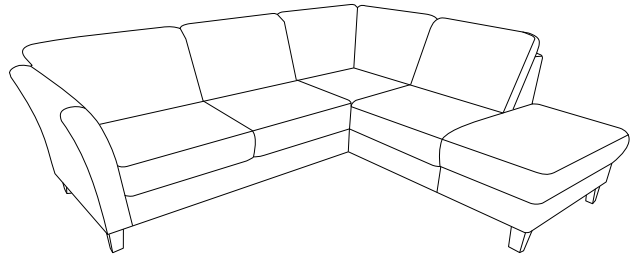
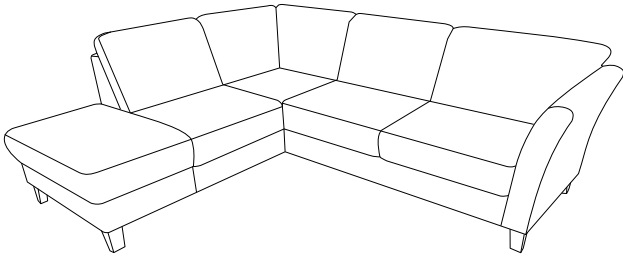

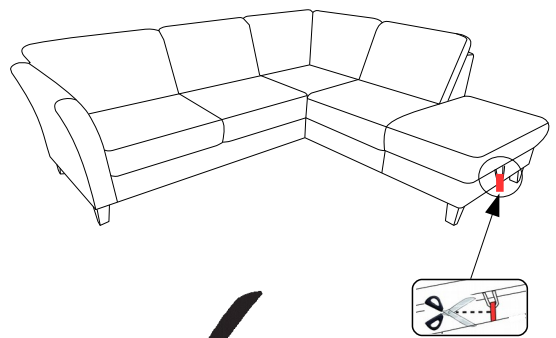
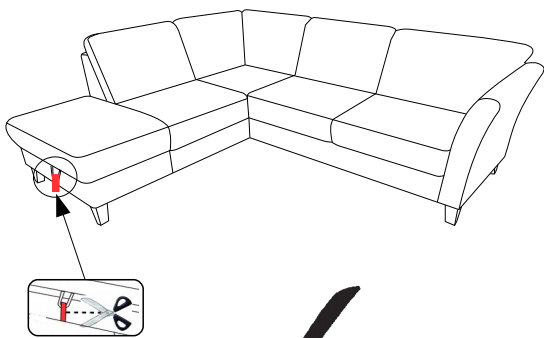
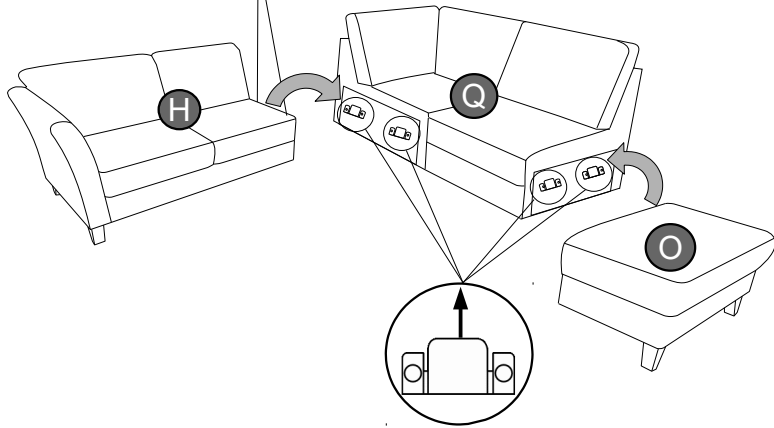
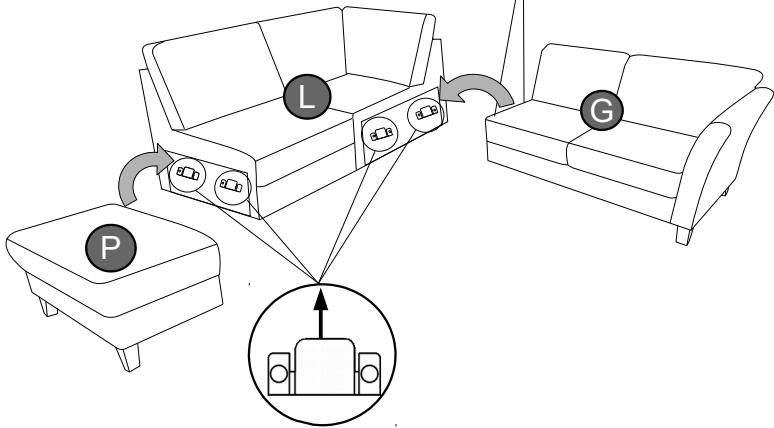
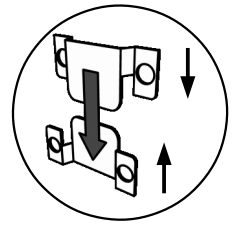
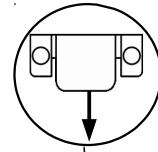
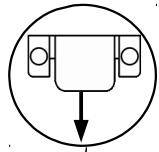
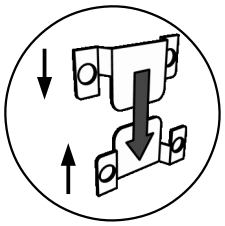
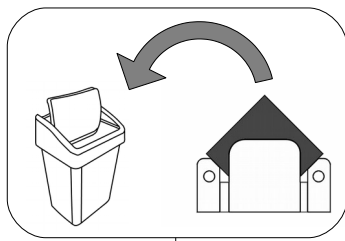

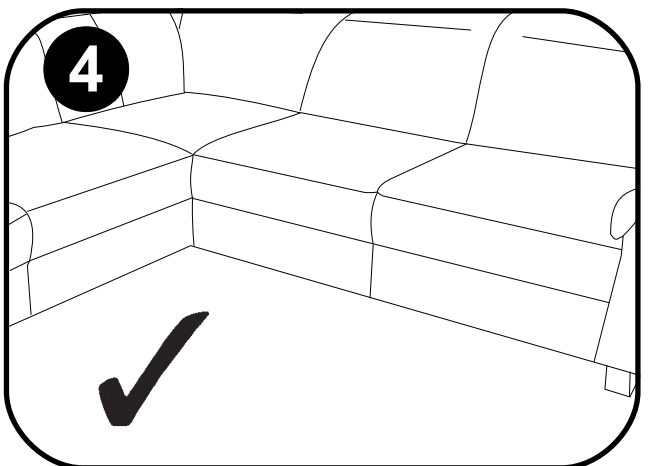
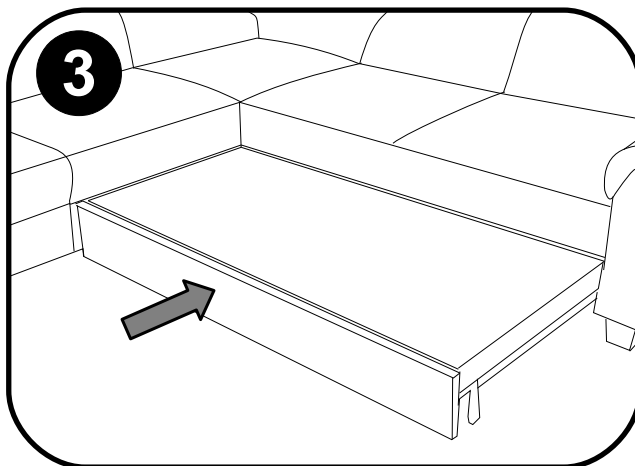
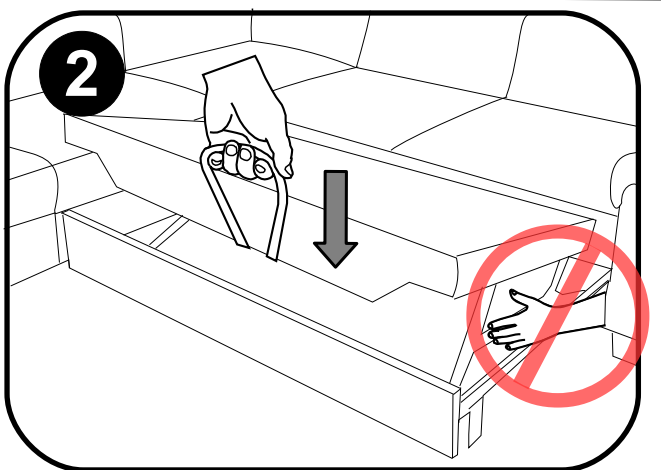
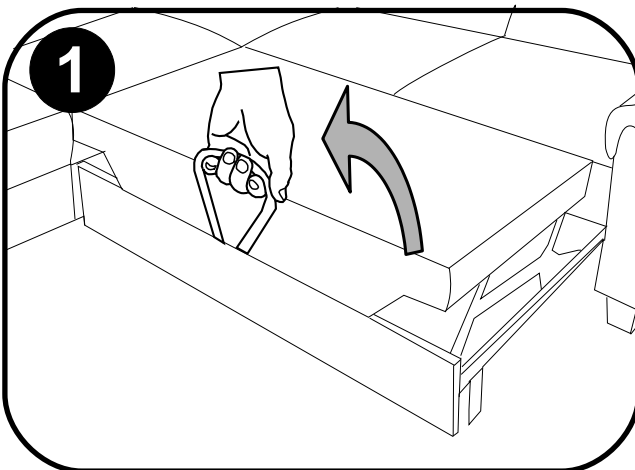
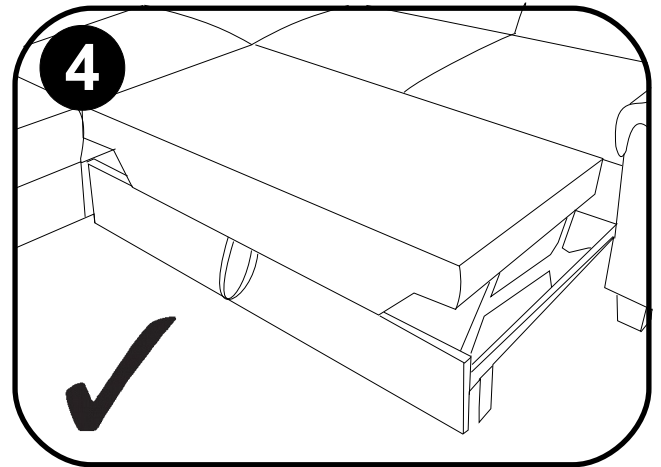
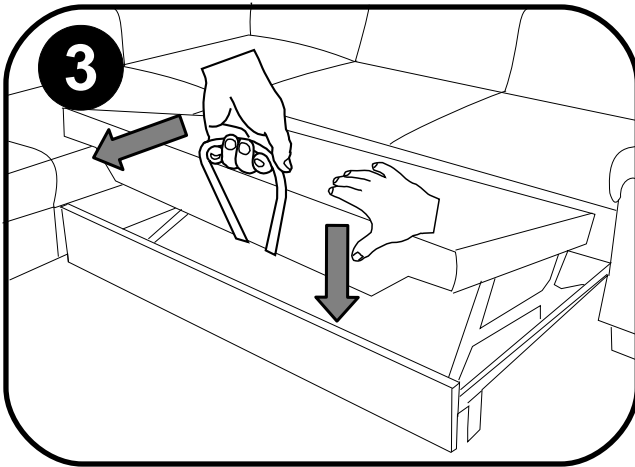
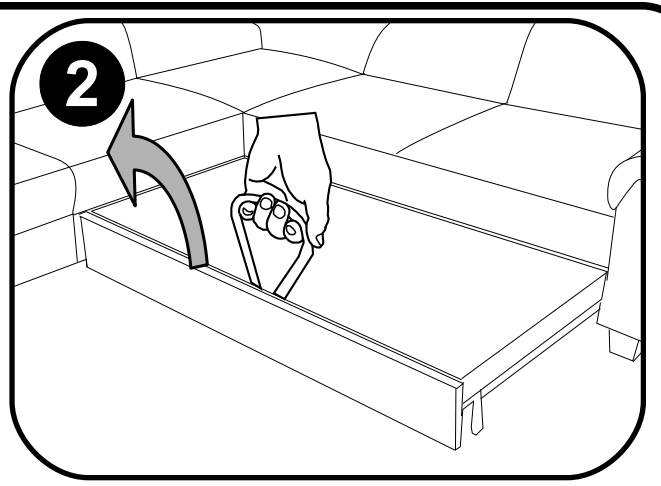
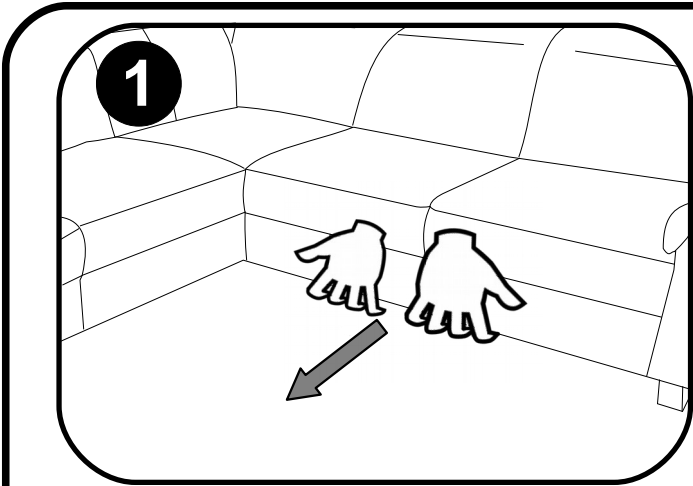
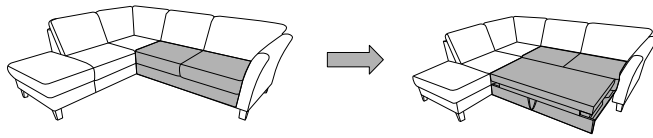

Service · Dienstverlening · Servis · Servis · Сервисная служба · Serviciu · Services · Servizio
 ·Servisný list · Szolgáltatás · Servisní list

Name · Naam · Nazwa · Ísim · Название · Nume · Nome · Názov · Názov ·
 Název · Neve

VISBY V

Typ · Type · Tip · Тип · Tipo · Típus

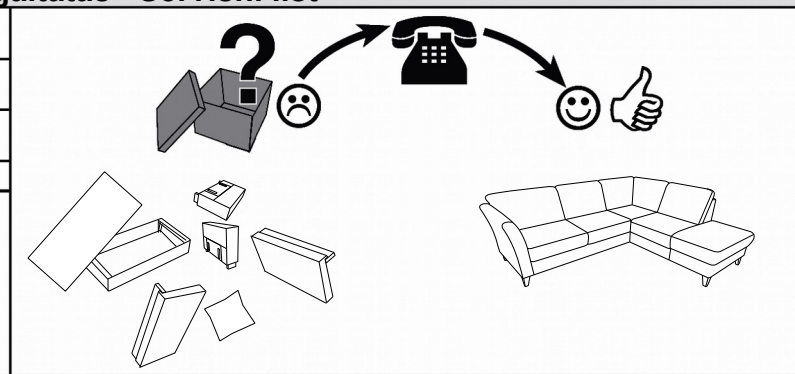
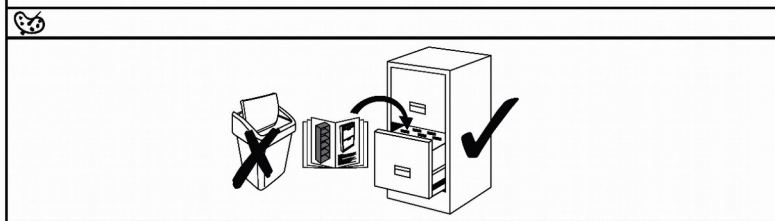

R

L

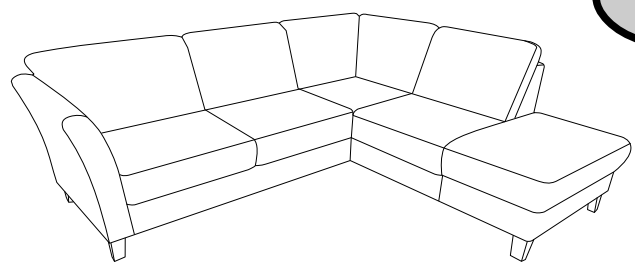
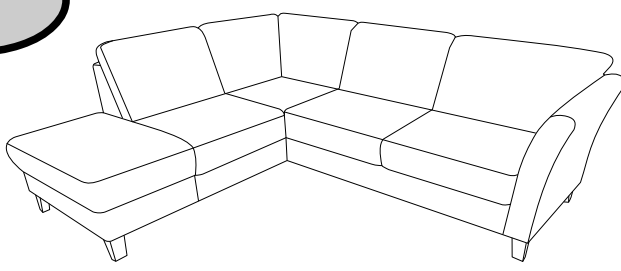
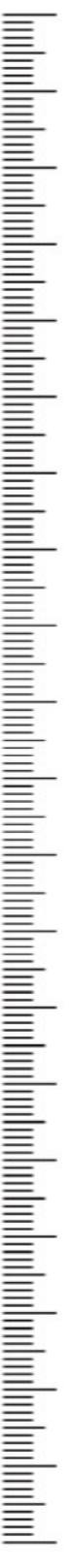

Z H-120 	V H-120 	i L-5 	S H-120 S₁ 	q M8*20
--------------------	--------------------	------------------	--	--------------------

