

- | | | | |
|---------------------------------------|-----------------------------------|------------------------------|----------------------------------|
| D Montageanleitung | GB Assembly Instructions | CZ Montážní návod | SK Návod na montáž |
| FR Notice de montage | IT Istruzioni di montaggio | HU Szerelési útmutató | RO Instrucțiuni de montaj |
| NL Handleiding voor de montage | PL Instrukcja montażu | TR Montaj talimatı | RU Инструкция по монтажу |

LIGHT CORNER

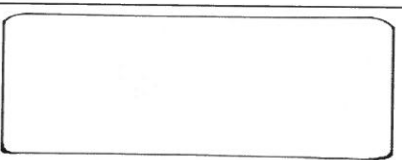
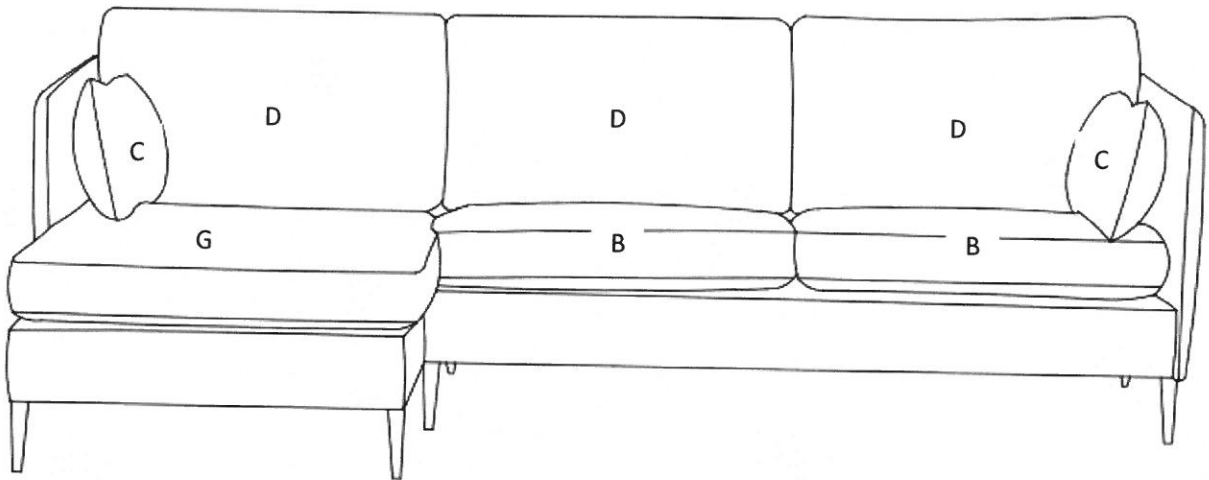

G

1x

GR 1

158x76x59

Ax4

Gx1

Dx1

CX1

Ex8

GR 2

162x95x59

Ax4

Bx2

Dx2

Cx1

Ex8

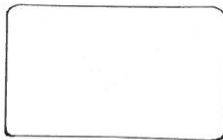

D

3x



E

16x

F



1x

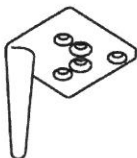

A

8x

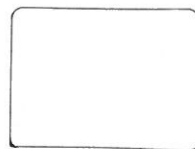

B

2x



C

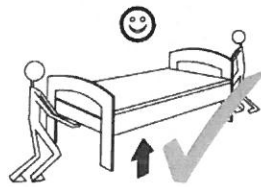
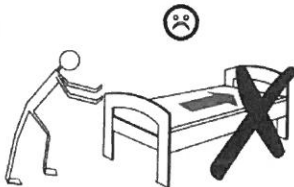
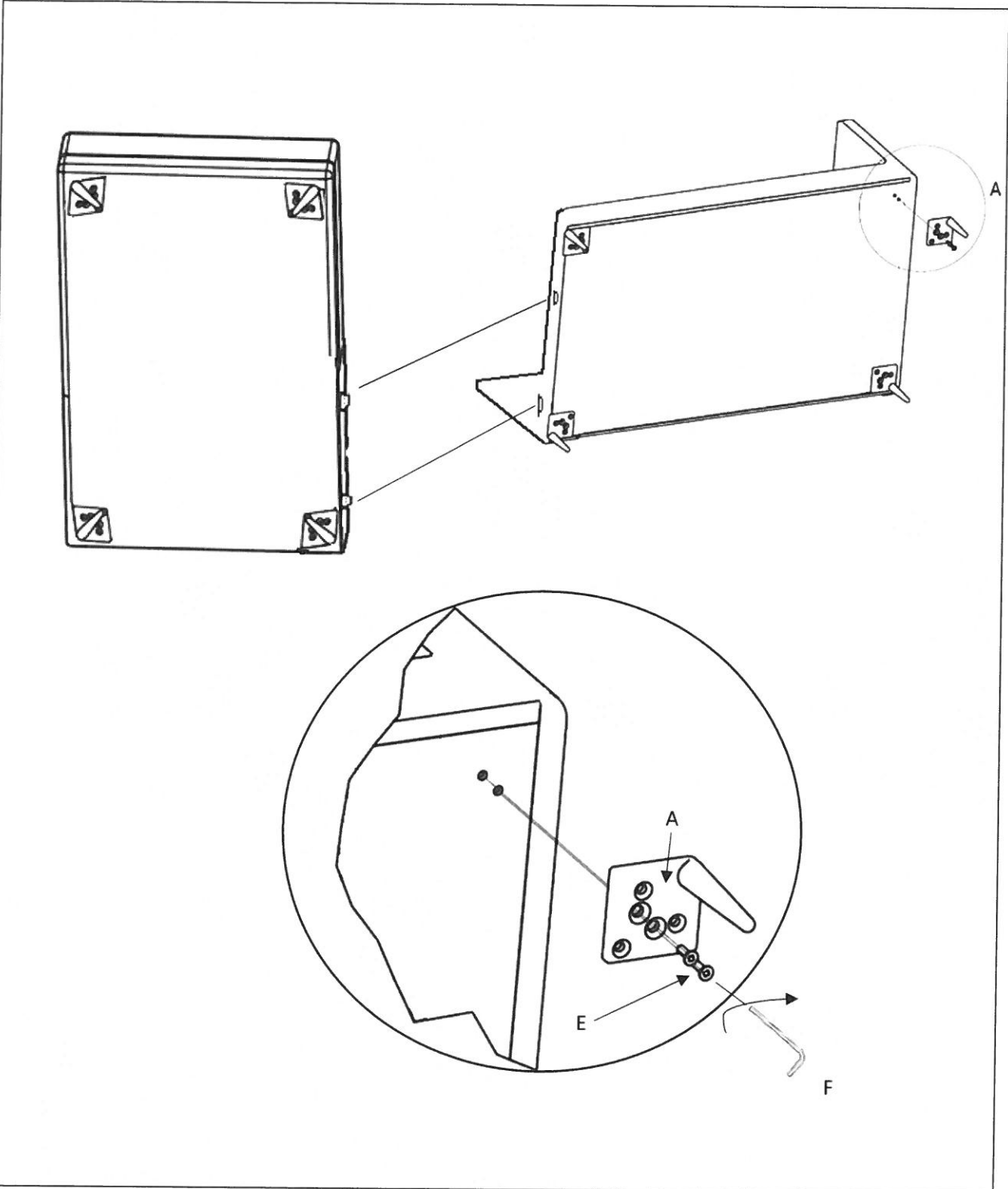

2x

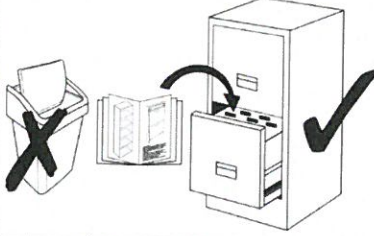

**Service • Assistenza • Dienstverlening • Serwis
Servis • Szerviz • Сервисная служба**

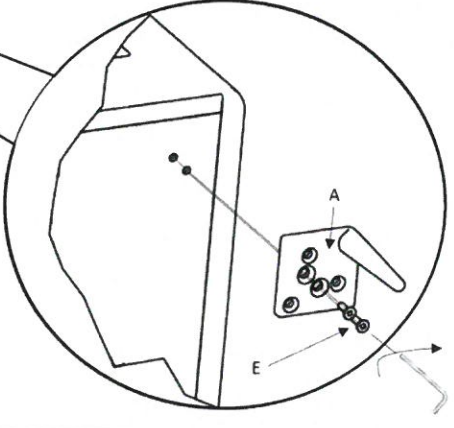
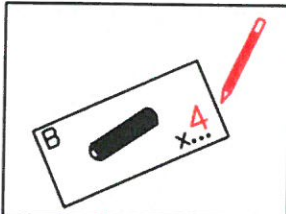
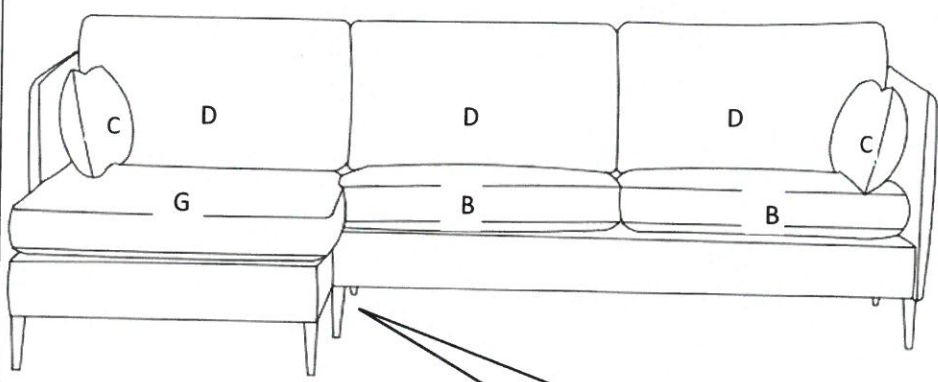
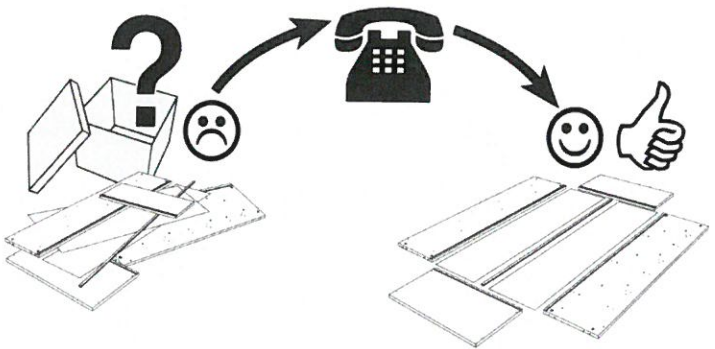
Name • Naam • Nazwa • isim • Название
LIGHT
Nr. • No. • Номер
Тур • Type • Тір • Тип
CORNER

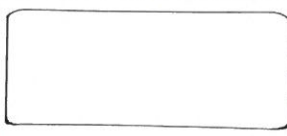
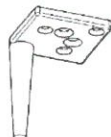
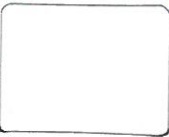



	
E		G	
	
A		B	
	
C		D	