

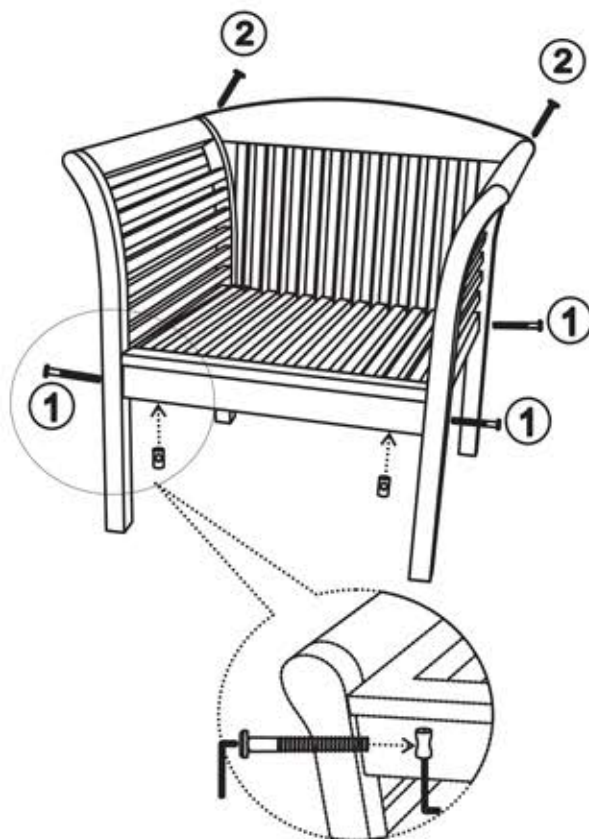



ASSEMBLY INSTRUCTION



- ① 
(M6 x 80) mm x 4 Pcs
- ② 
(M7 x 45) mm x 2 Pcs
- ③ 
(M4 x 30) mm x 3 Pcs

