

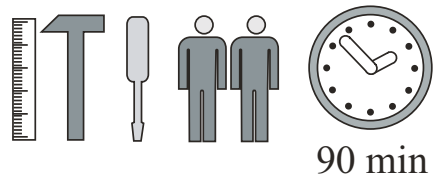

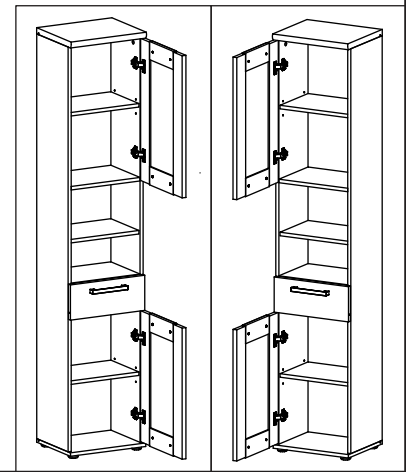

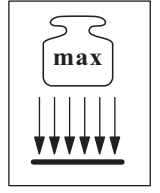

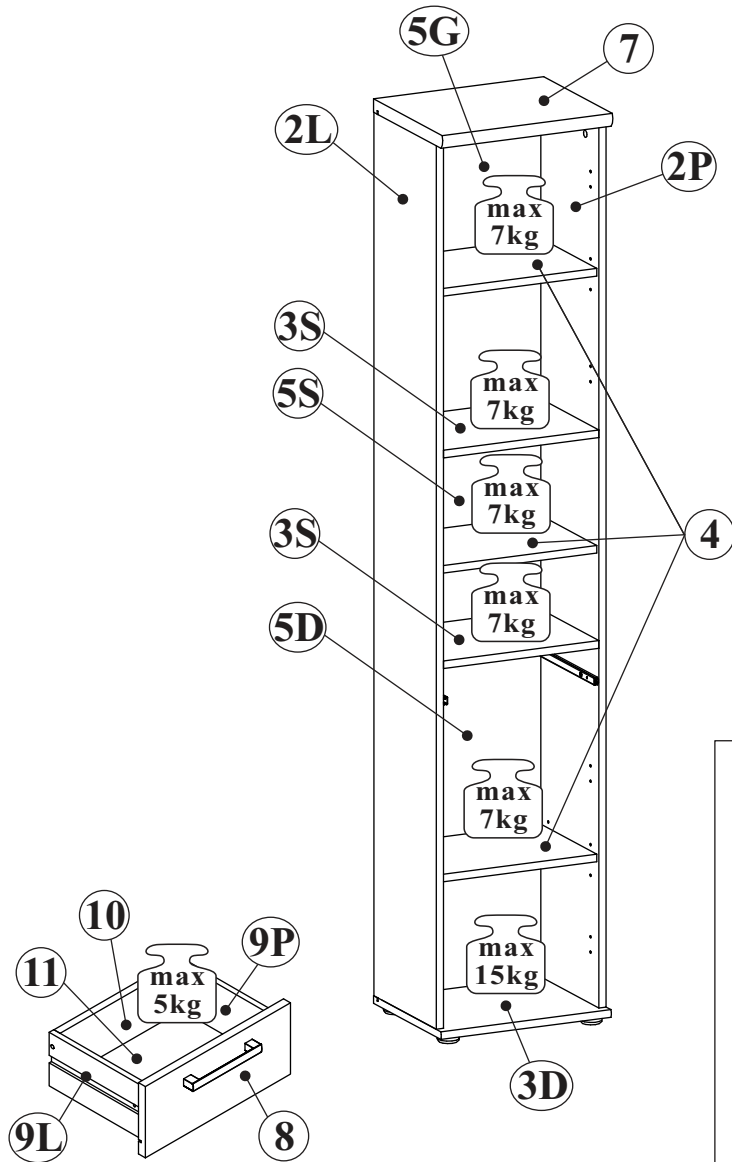

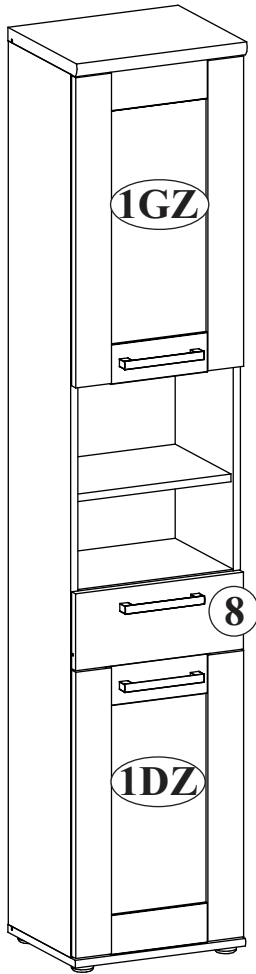
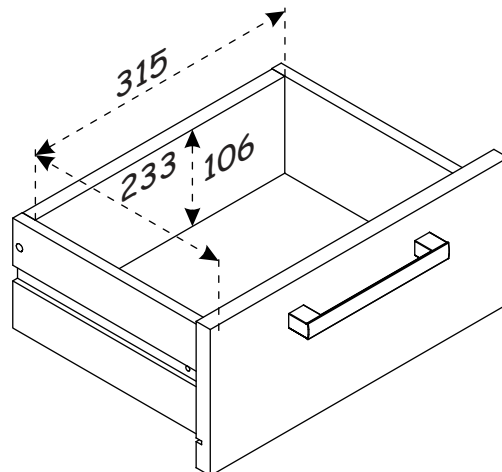
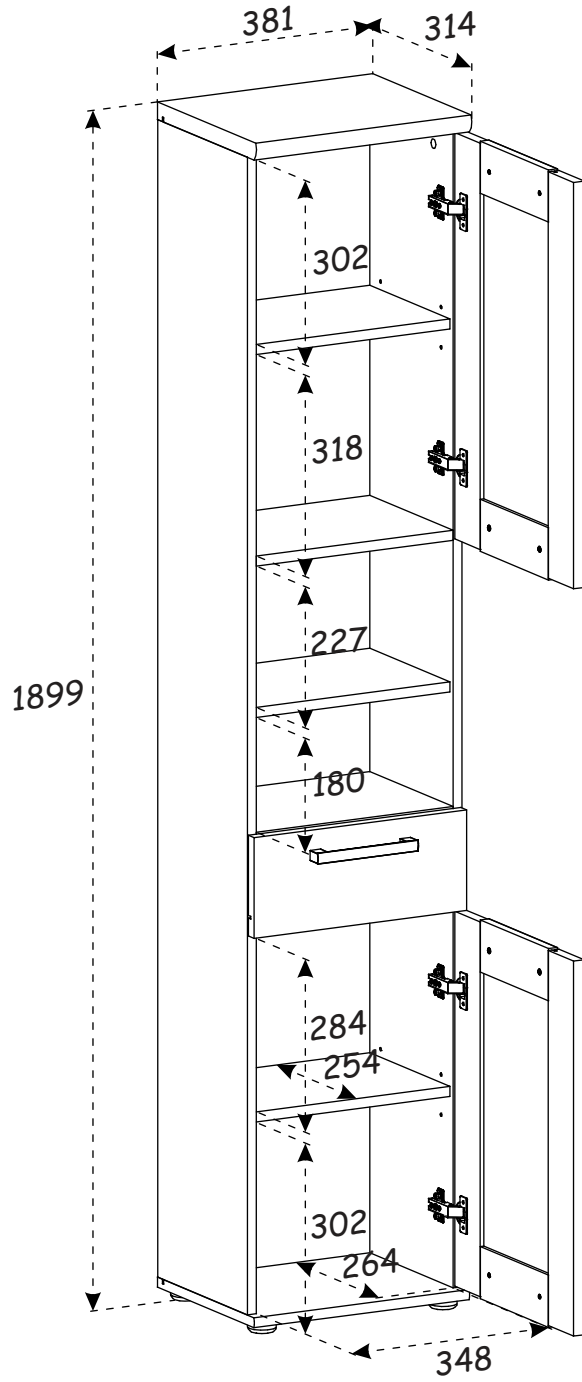

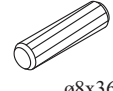
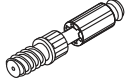



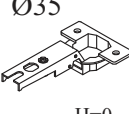
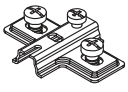

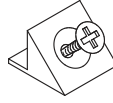



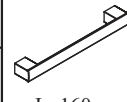

BERGEN

70-046-__-6

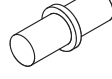

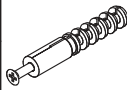
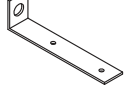

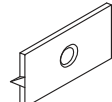
| NO | Dim. | | | Col.-No | Qty |
|-----|------|-----|----|---------|-----|
| 1DZ | 596 | 376 | 19 | 1 | 1 |
| 1GZ | 646 | 376 | 19 | 1 | 1 |
| 2L | 1840 | 284 | 16 | 1 | 1 |
| 2P | 1840 | 284 | 16 | 1 | 1 |
| 3D | 381 | 307 | 16 | 1 | 1 |
| 3S | 348 | 264 | 16 | 1 | 2 |
| 4 | 348 | 254 | 16 | 1 | 3 |
| 5D | 763 | 360 | 3 | 1 | 1 |
| 5S | 439 | 360 | 3 | 1 | 1 |
| 5G | 650 | 360 | 3 | 1 | 1 |
| 7 | 381 | 314 | 28 | 1 | 1 |
| 8 | 376 | 160 | 18 | 1 | 1 |
| 9L | 250 | 120 | 12 | 1 | 1 |
| 9P | 250 | 120 | 12 | 1 | 1 |
| 10 | 315 | 106 | 16 | 1 | 1 |
| 11 | 255 | 326 | 3 | 1 | 1 |



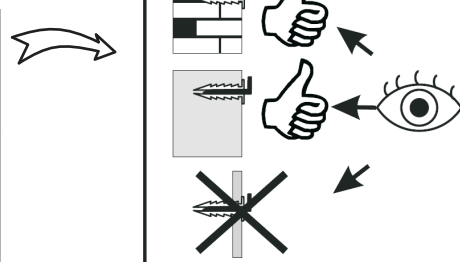
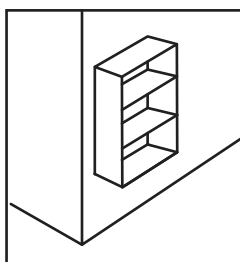
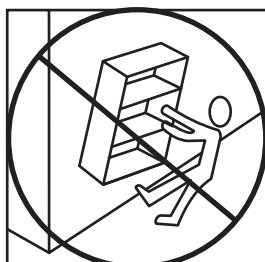
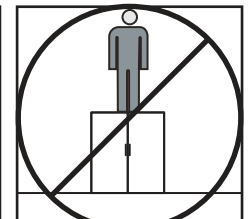
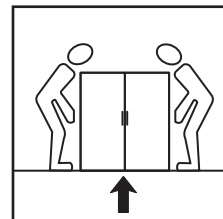
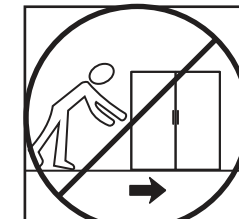
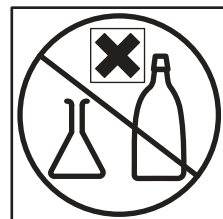
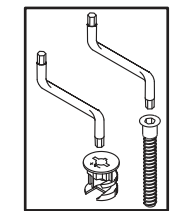
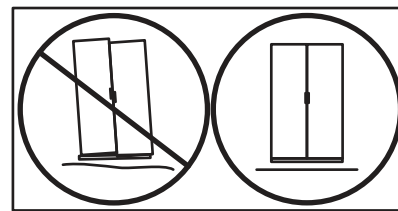
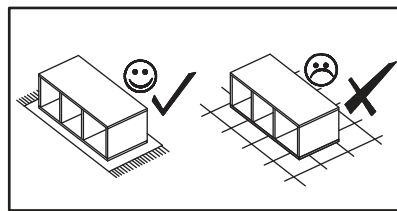
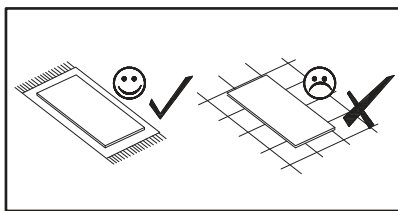
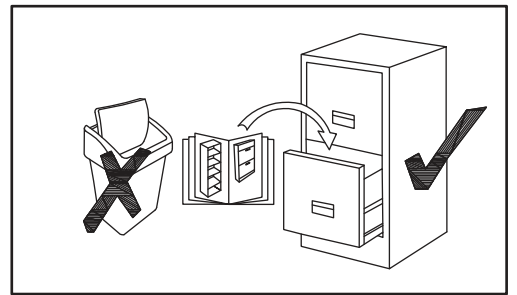
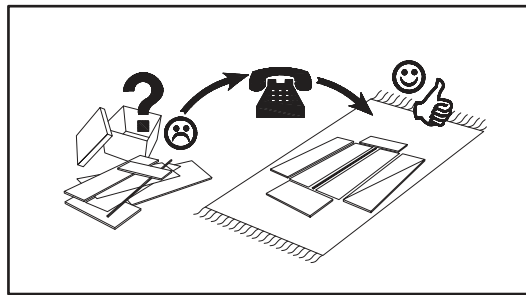
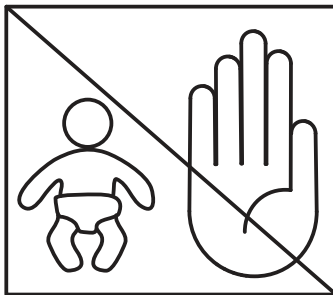
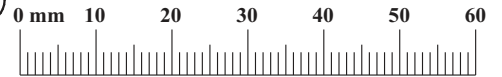

| | | | | | |
|--|---|--|--|---|--|
| A1 x20  ø8x36 | B4 x14  | B5 x12  ø15x12 | G5 x12  | B7 x2  Ø15x10,3 | G8 x2  Ø20 |
| E21 x4 Ø35 H=0  | E2 x4 H=0  | D10 x10 USØ3,5x13  | S1 x15  | B11 x6 Ø7x50  | G4 x6  |
| H6 x1 L=250mm.  | D18 x2 M4x9  | D20 x4 ESØ6x9,5  | UP13 x12 UPØ3x16  | CN1 x3 L=160mm  | UP16 x6 UPØ4x35  |
| I11 x4 Ø45, h=15  | D11 x4 USØ3,5x25  | G7 x10  | Z2 x8 Ø5  | KR1 x1  | L1 x1  |
| G2 x1  | G16 x6  | G12 x4 Ø14  | PH x2  | | |

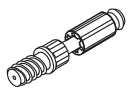

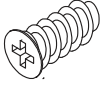
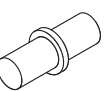

1

| | | | | | |
|----|--|----|---|----|---|
| A1 |  | B4 |  | B5 |  |
| x8 | ø8x36 | x8 | | x4 | ø15x12 |

| | | | | | |
|----|--|-----|---|-----|---|
| H6 |  | D20 |  | G7 |  |
| x1 | L-250mm | x4 | ESØ6x9,5 | x10 | |

| | |
|----|---|
| PH |  |
| x2 | |

| | | | |
|--------|---|------|---|
| 10,3mm |  | 12mm |  |
| | B7 | | B5 |

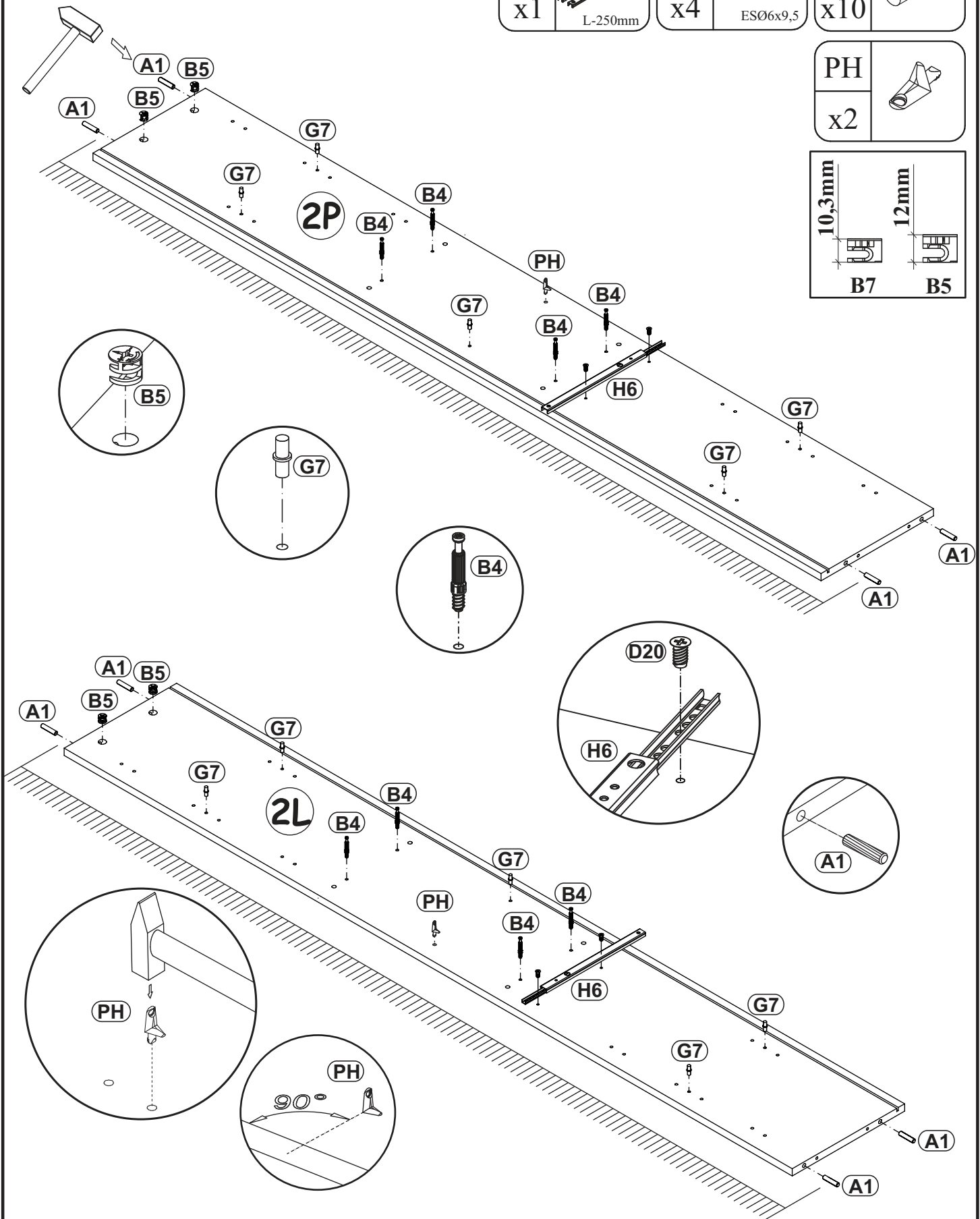

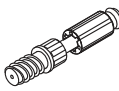

2

| | |
|----|--|
| A1 |  |
| x8 | ø8x36 |

| | |
|----|---|
| B4 |  |
| x4 | |

| | |
|----|---|
| B5 |  |
| x8 | ø15x12 |

| | |
|-----|---|
| I11 |  |
| x4 | Ø45, h=15 |

| | |
|-----|---|
| D11 |  |
| x4 | USØ3,5x25 |

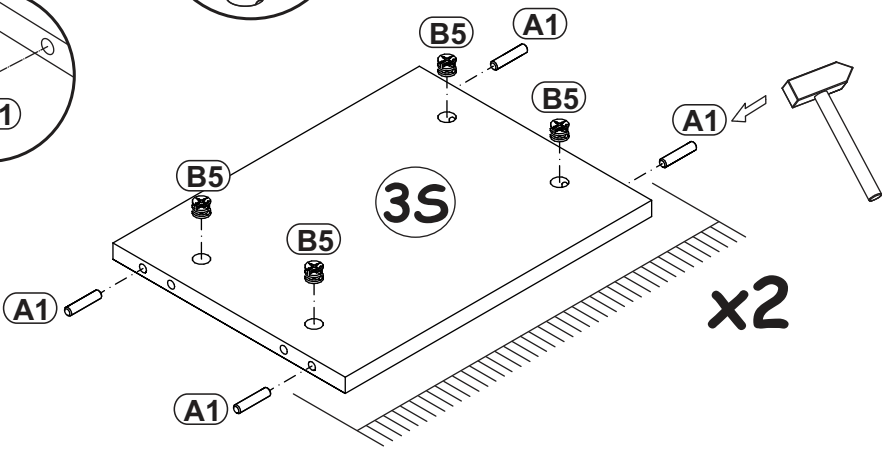
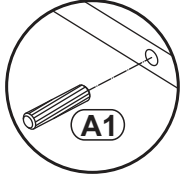
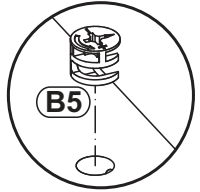
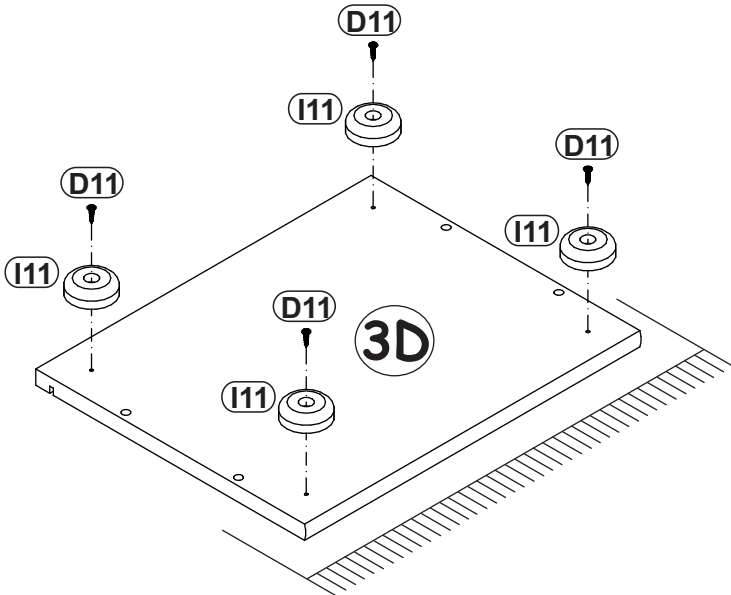
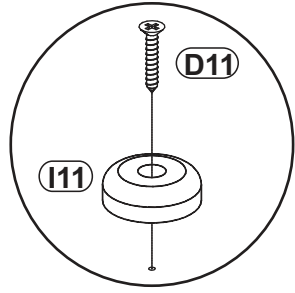
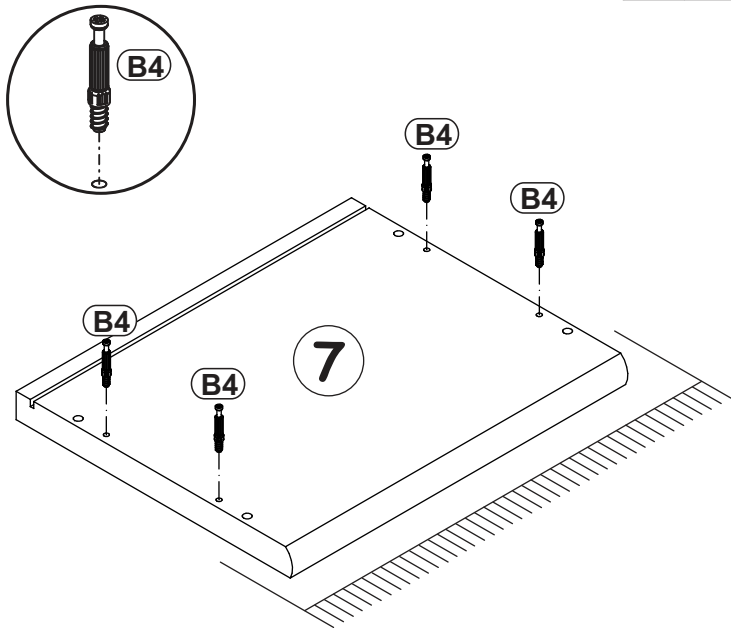
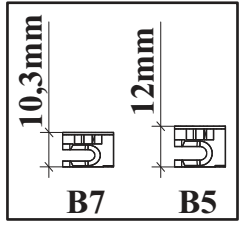

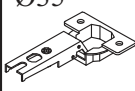
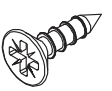
| | | | |
|-----|--|-----|--|
| E21 | Ø35 | D10 | |
| x4 |  H=0 | x8 |  USØ3,5x13 |

3

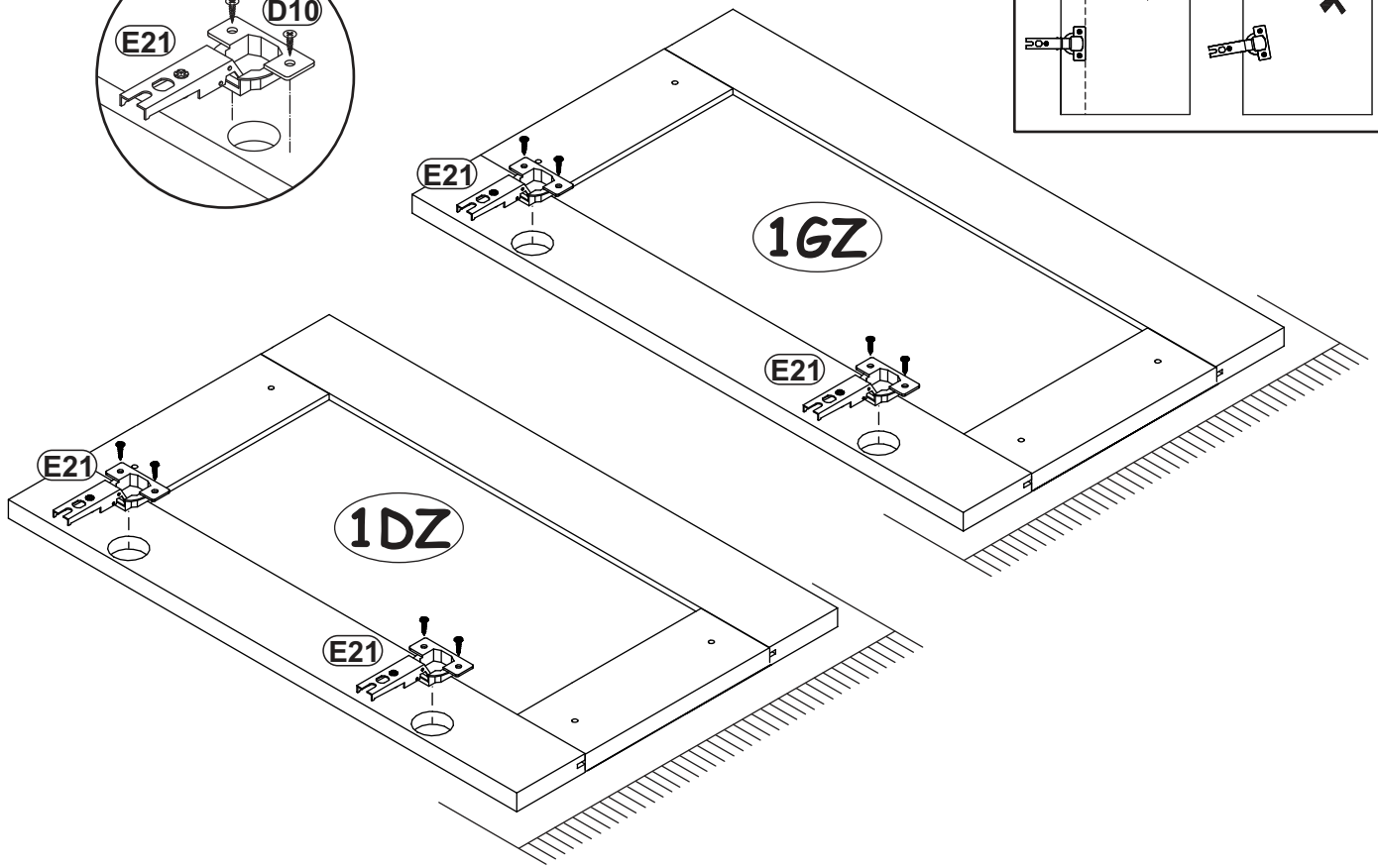
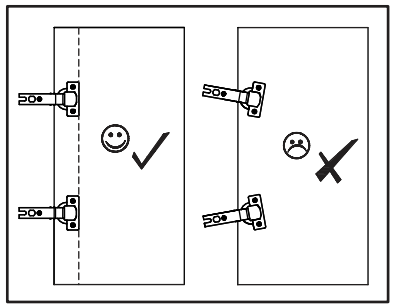
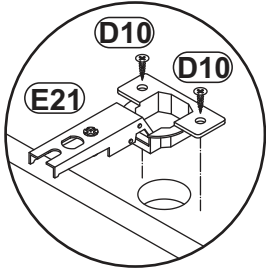

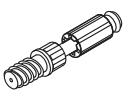

4

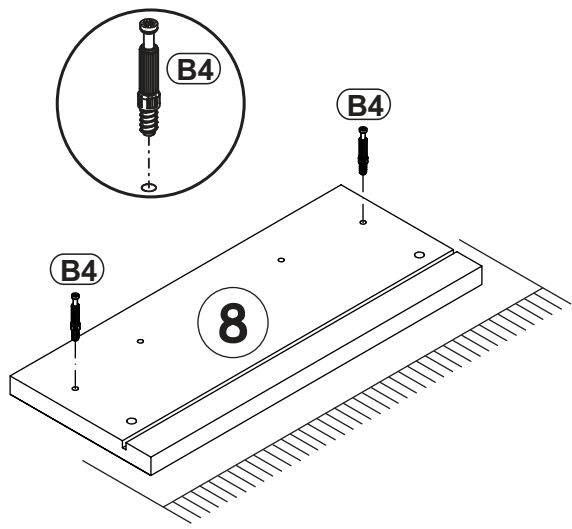
| | |
|----|---|
| B4 |  |
| x2 | |



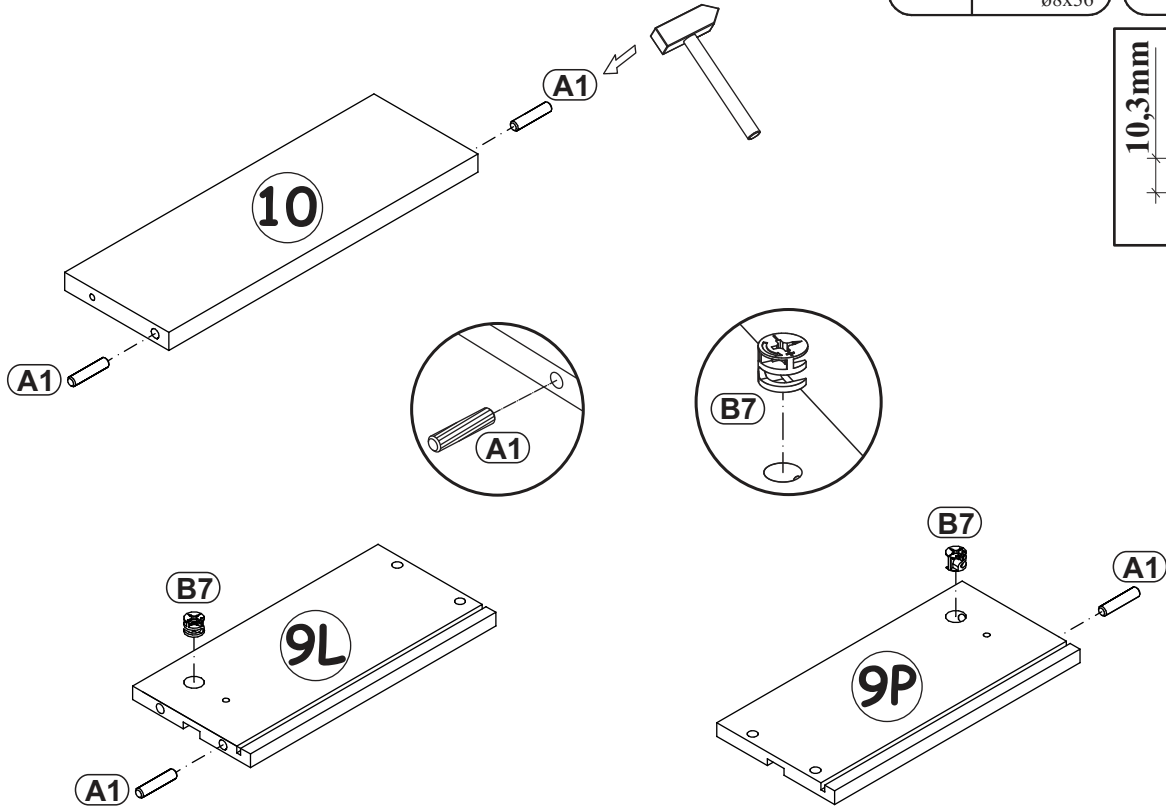
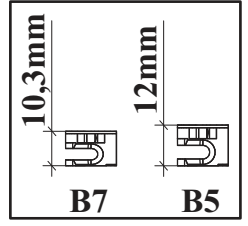

5

| | | | |
|----|---|----|---|
| A1 |  | B7 |  |
| x4 | ø8x36 | x2 | Ø15x10,3 |



6

| | | | | | |
|----|--|-----|---|----|---|
| G8 |  | B11 |  | G4 |  |
| x2 | Ø20 | x2 | Ø7x50 | x2 | |

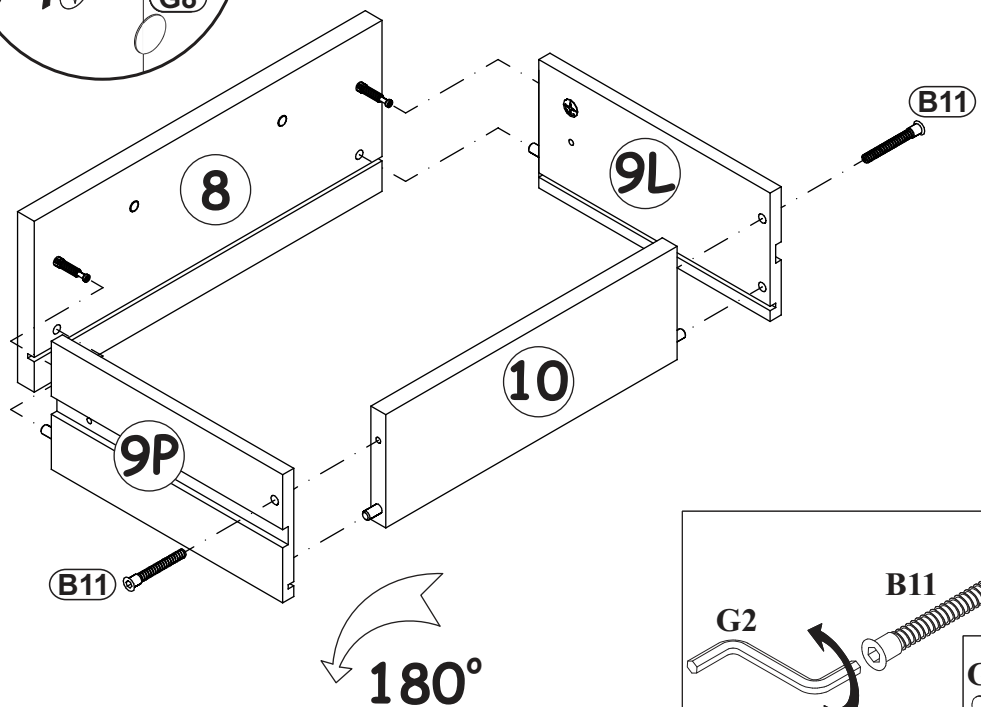
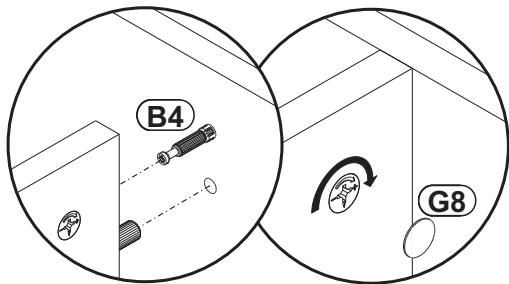

7

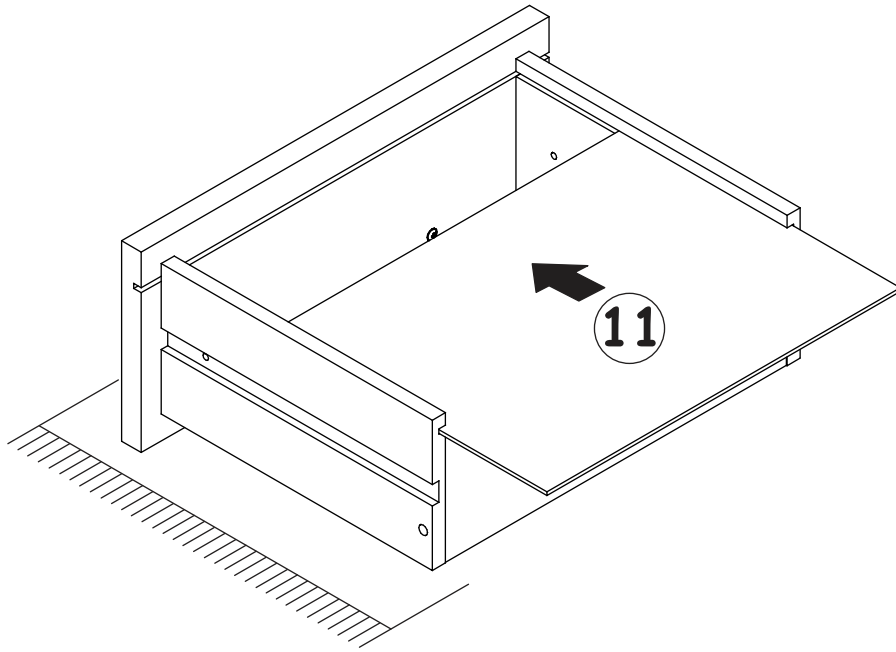

8

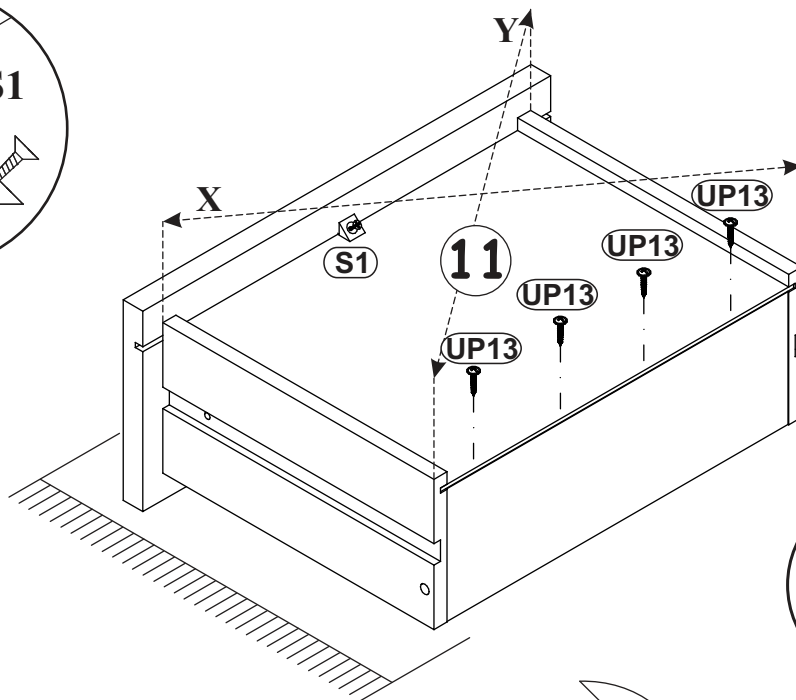
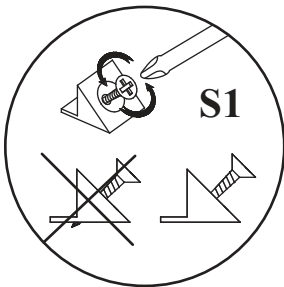
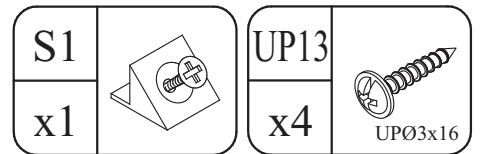

180°

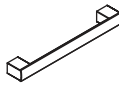
| | |
|-----|---|
| CN1 |  |
| x1 | L=160mm |

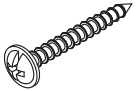
| | |
|------|---|
| UP16 |  |
| x2 | UPØ4x35 |

9

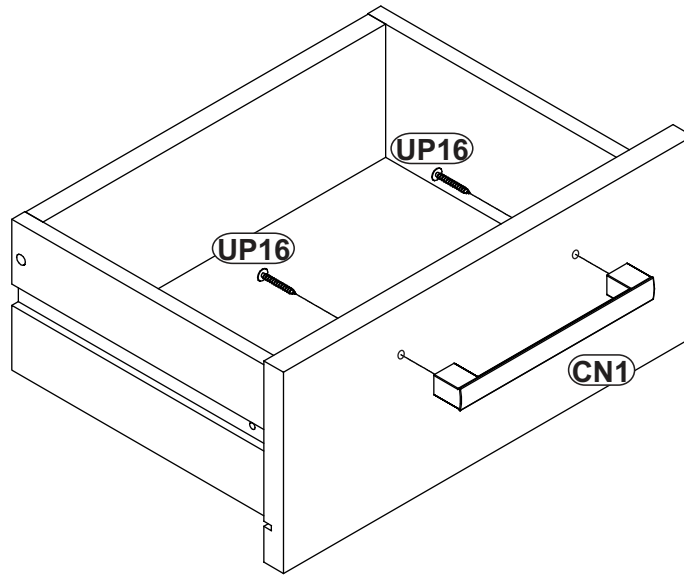

10

| | |
|----|---|
| G5 |  |
| x8 | |

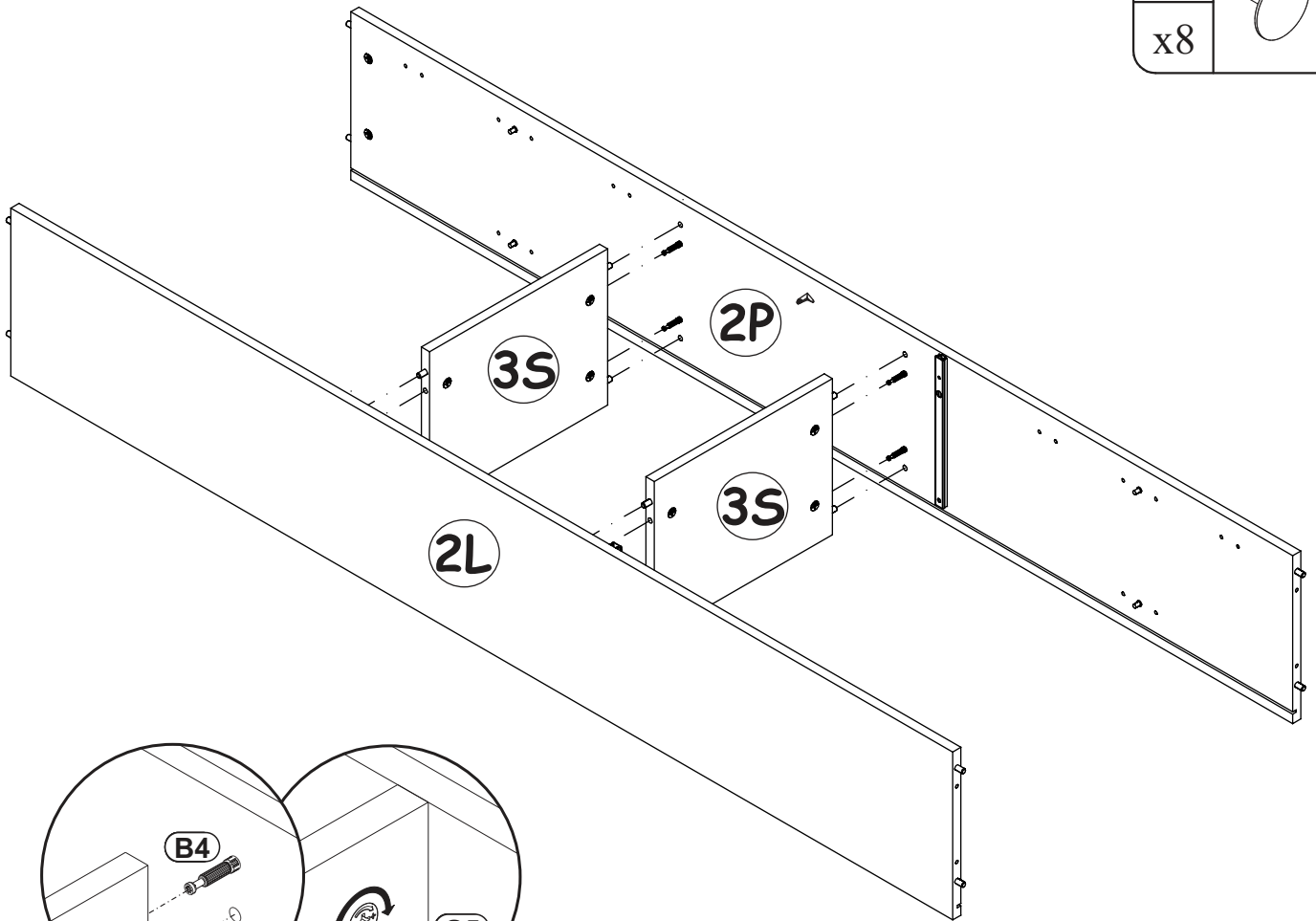

| | | | | | |
|----|--|-----|-------|----|--|
| G5 | | B11 | | G4 | |
| x4 | | x4 | Ø7x50 | x4 | |

11

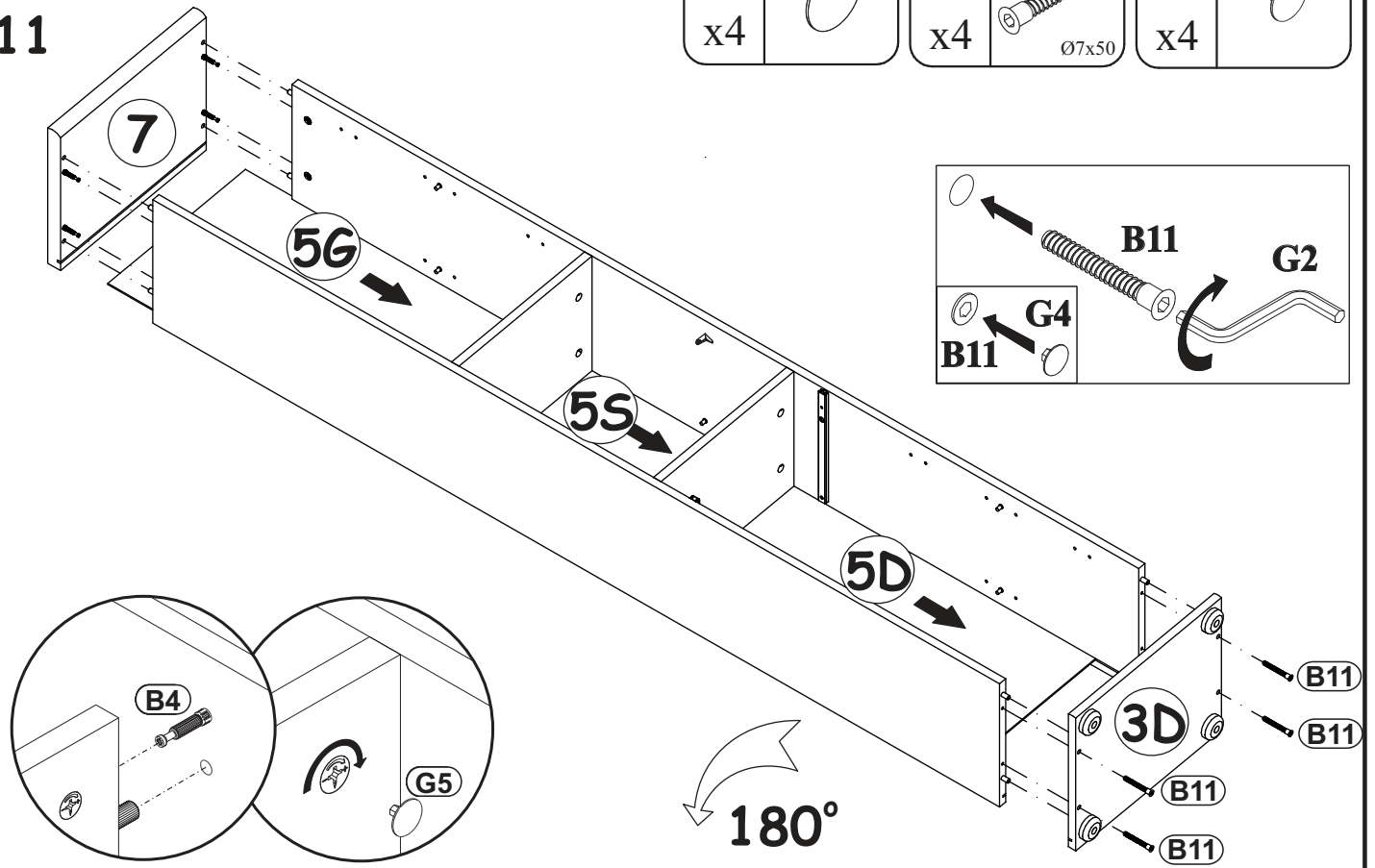

12

| | | | | | |
|-----|--|-----|--|------|---------|
| S1 | | G16 | | UP13 | |
| x14 | | x6 | | x6 | UPØ3x16 |

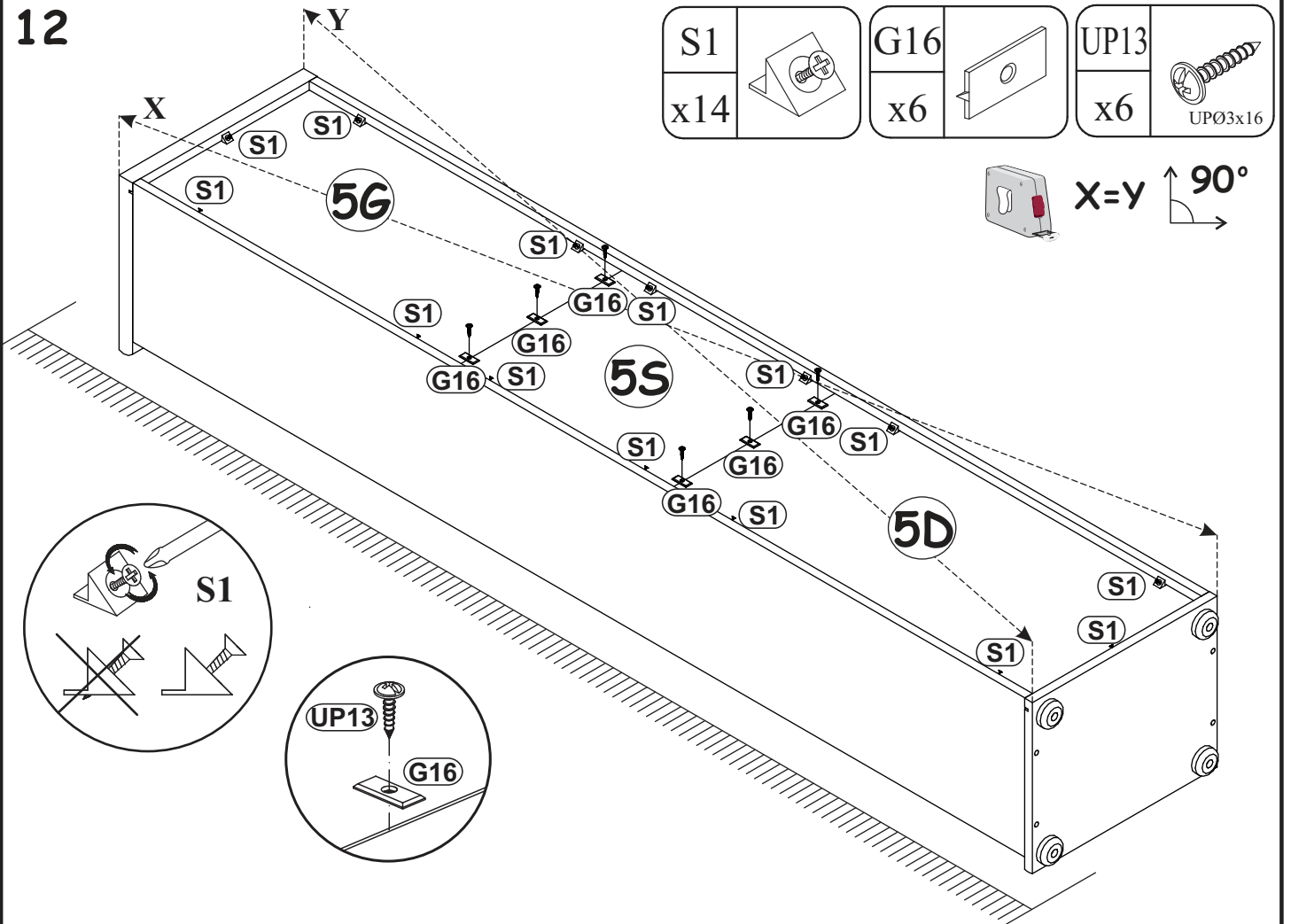

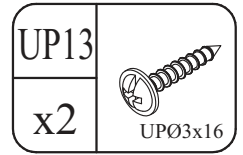
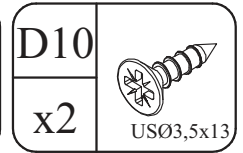
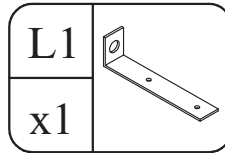
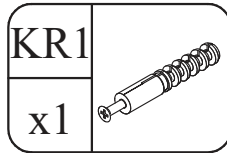

13

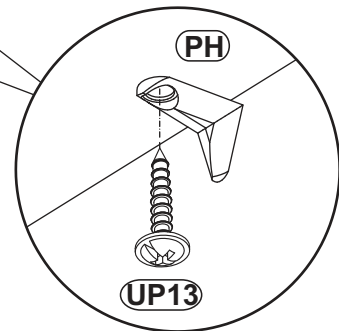
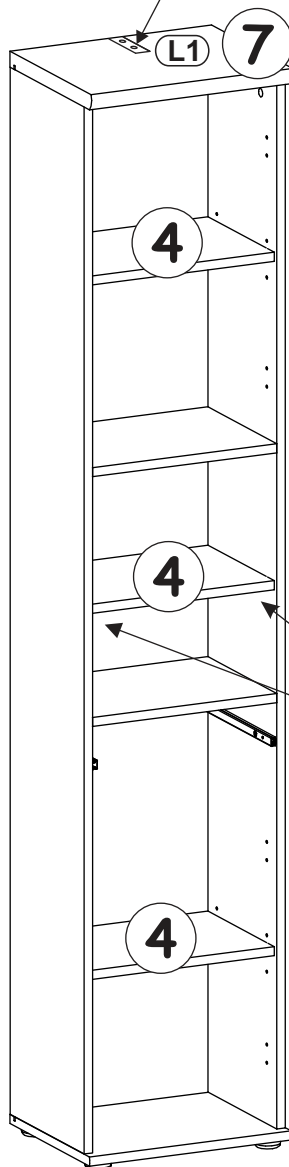
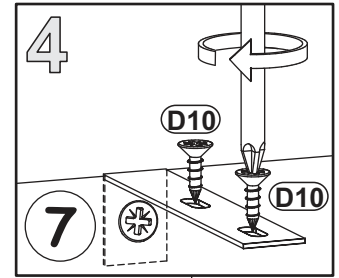
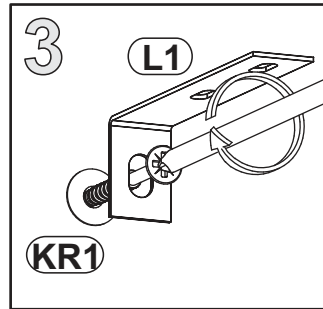
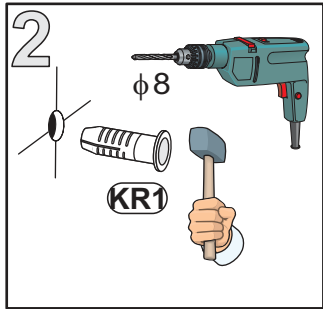
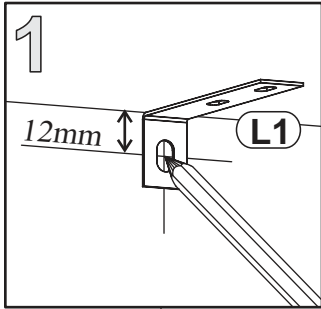
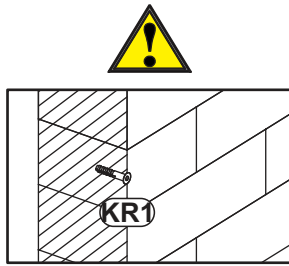
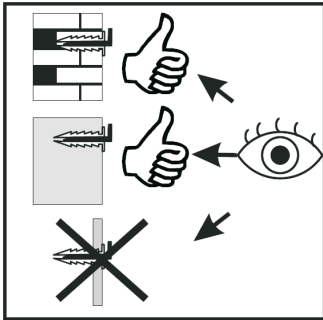

14-17

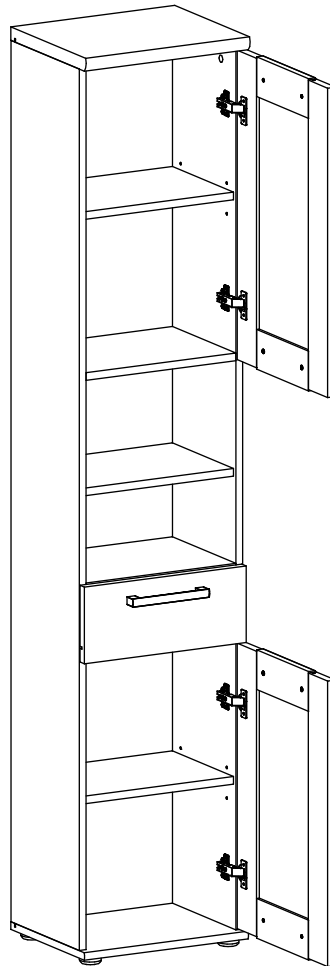

18-21

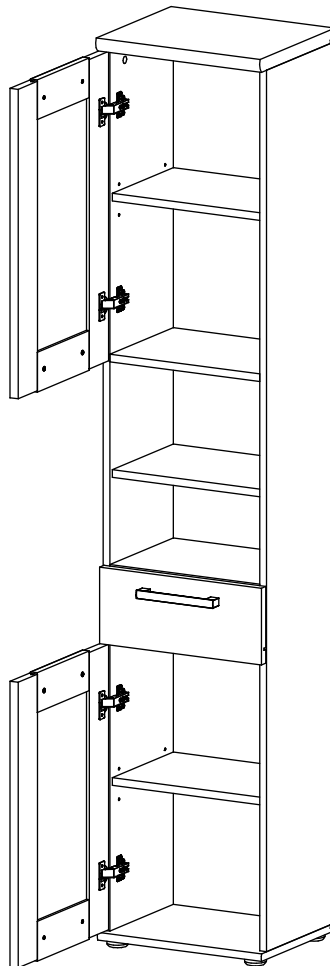

14

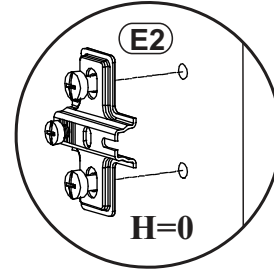
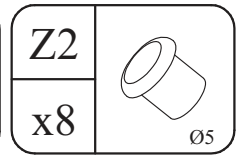
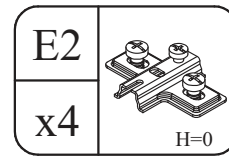
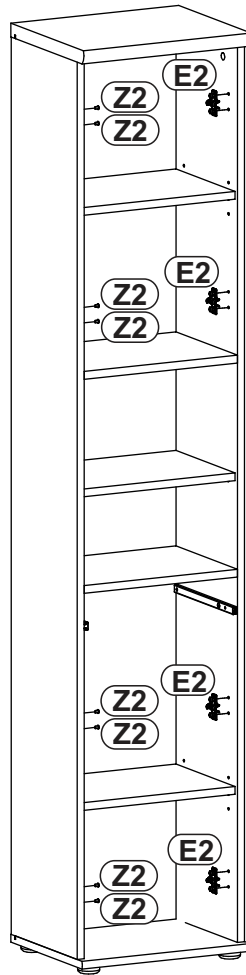
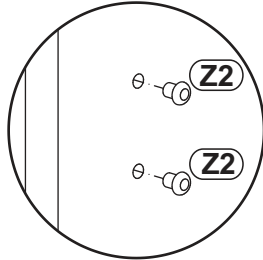
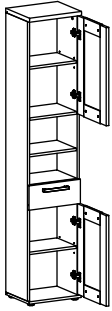

15

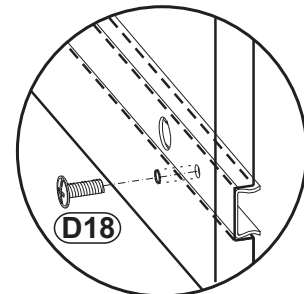
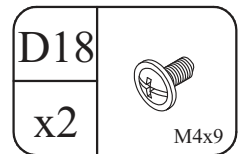
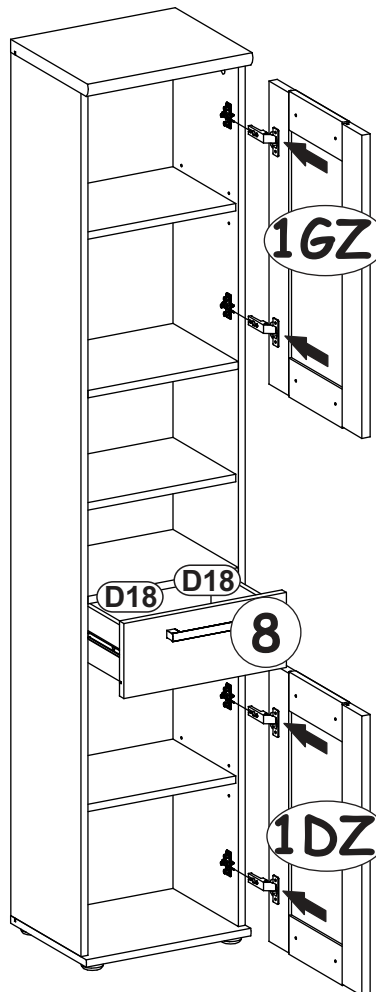
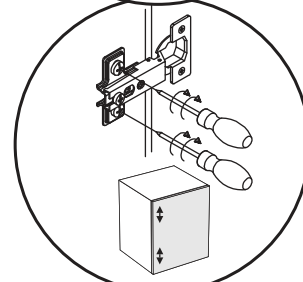
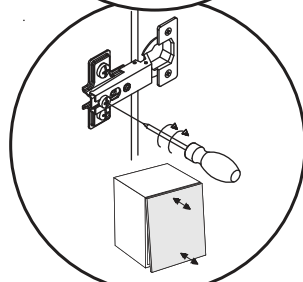
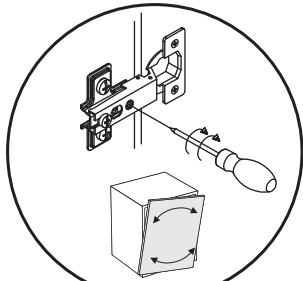

16

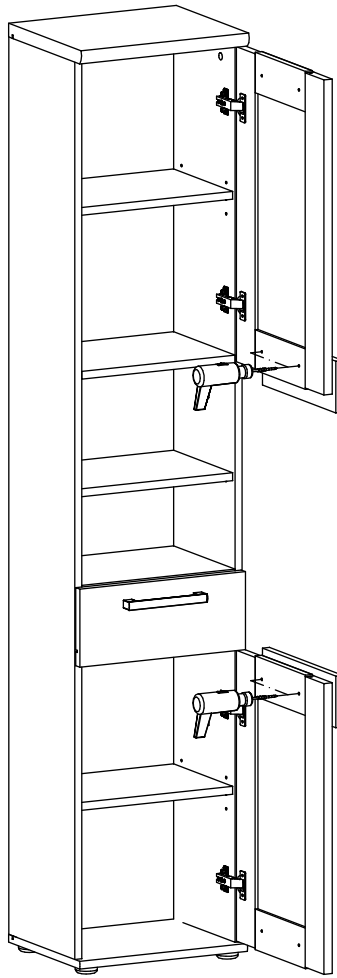
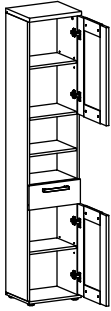



ø5!!!

ø5!!!

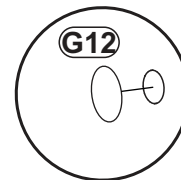
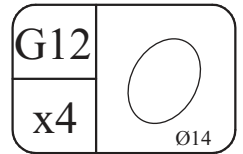
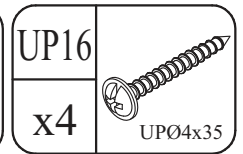
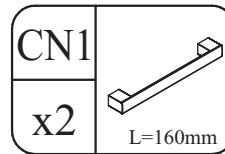
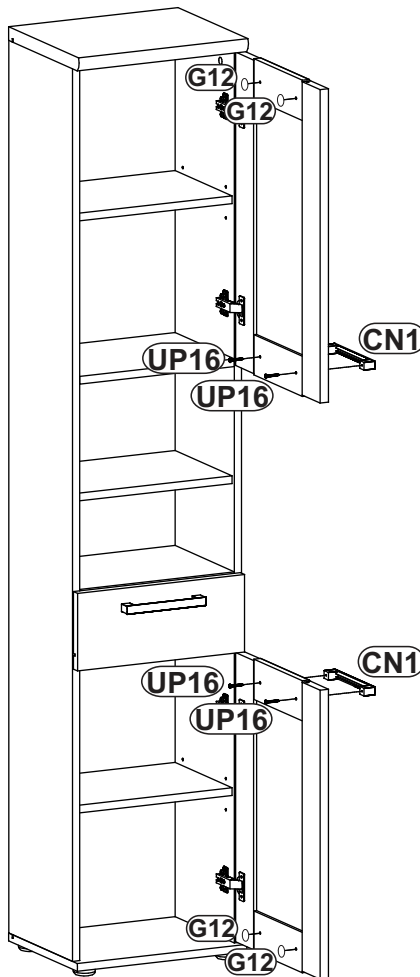
17

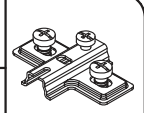

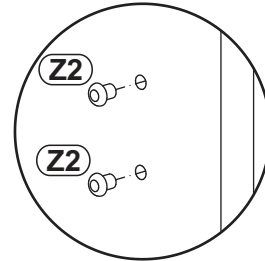
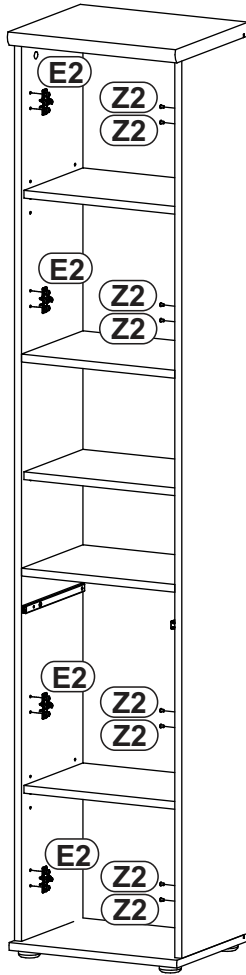
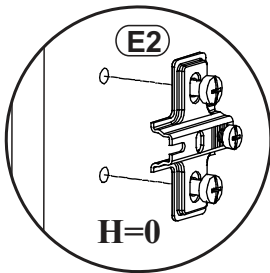
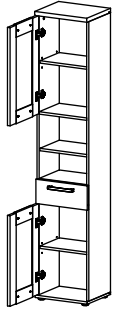

| | | | |
|----|--|----|---|
| E2 |  | Z2 |  |
| x4 | H=0 | x8 | Ø5 |

18

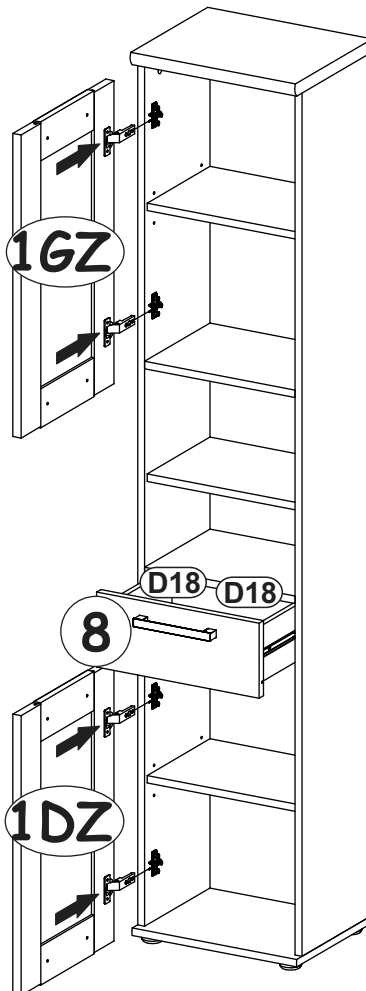
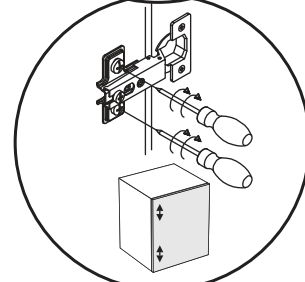
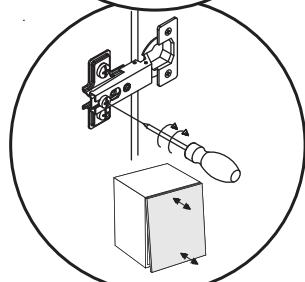
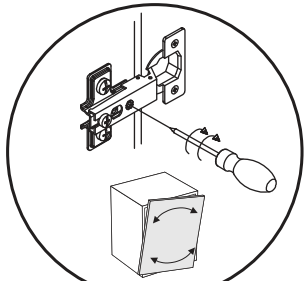

19



| | |
|-----|---|
| D18 |  |
| x2 | M4x9 |

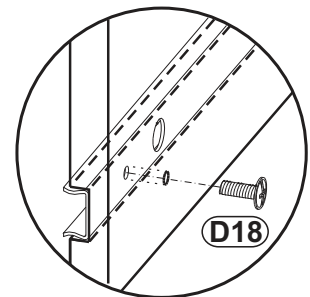

20

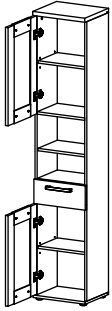

ø5 !!!

ø5 !!!

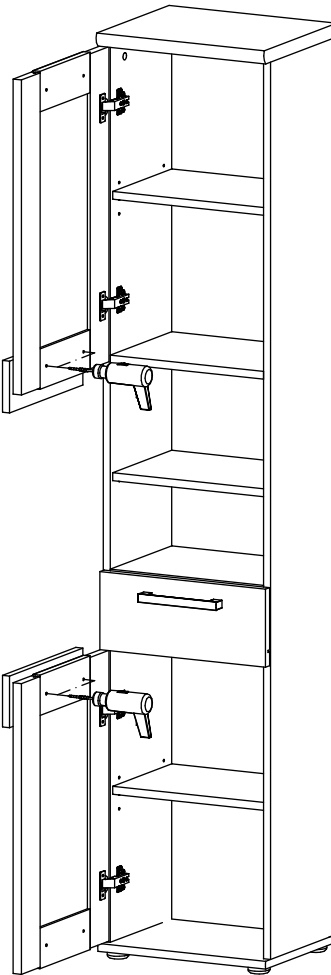

21

