

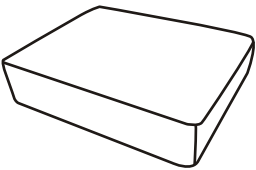

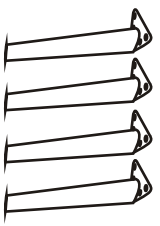
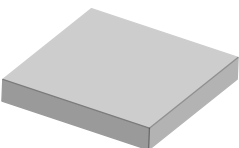

**INSTRUCTION MANUAL/BEDIENUNSANLEITUNG/NOTICE D'UTILISATION/  
MANUAL DE INSTRUCCIONES DE USO/MANUALE DI ISTRUZIONI  
PARTS LIST/STÜCKLISTE/PARTS LIST/LISTA DE PIEZAS/LISTA DEI PEZZI**

<p><b>A</b></p>  <p>1pc</p>	<p><b>B</b></p>  <p>4pcs</p>	<p><b>C</b></p>  <p>1pc</p>	<p><b>D</b></p>  <p>4pcs</p>	<p><b>E</b></p>  <p>M6*20 16pcs</p> <p><b>F</b></p>  <p>1pc</p>
--	---	--	---	---

**ASSEMBLY/MONTAGE/ASSEMBLAGE/MONTAJE/ASSEMBLAGGIO**

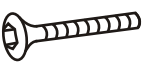

**Warning!** Tight all the screws to 60% first then tight to 100%.  
**Warnung!** Während der Montage alle Schrauben zuerst 60% anziehen, dann zu 100%.  
**Attention !** Serrez toutes les vis à 60% d'abord puis serrez à 100%.  
**Atención!** Primero apriete los tornillos al 60% y después al 100%.  
**Avvertimento!** Stringere le viti dapprima al 60% e successivamente completamente al 100%.

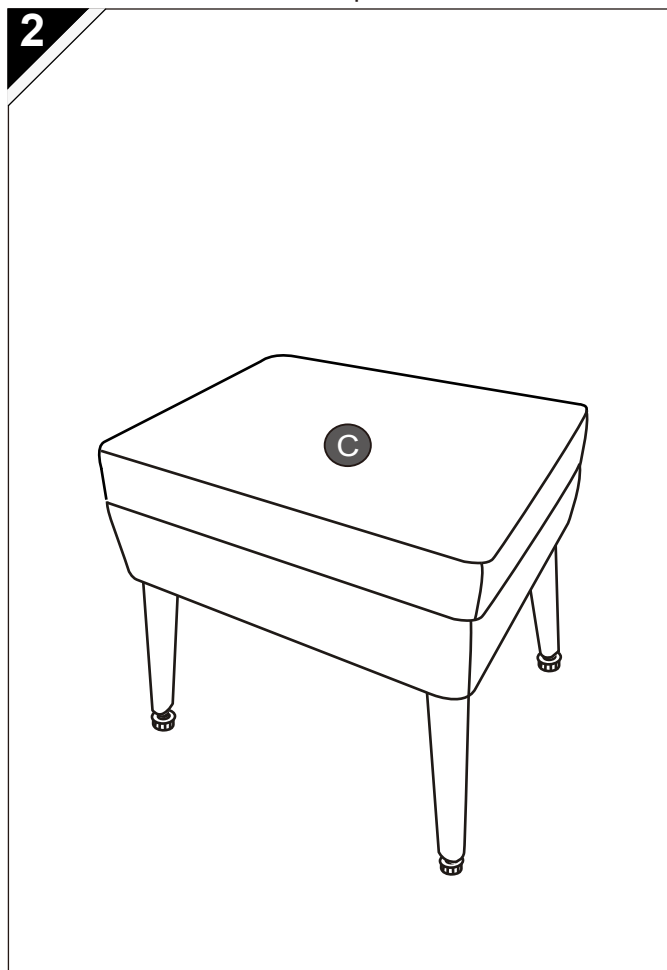
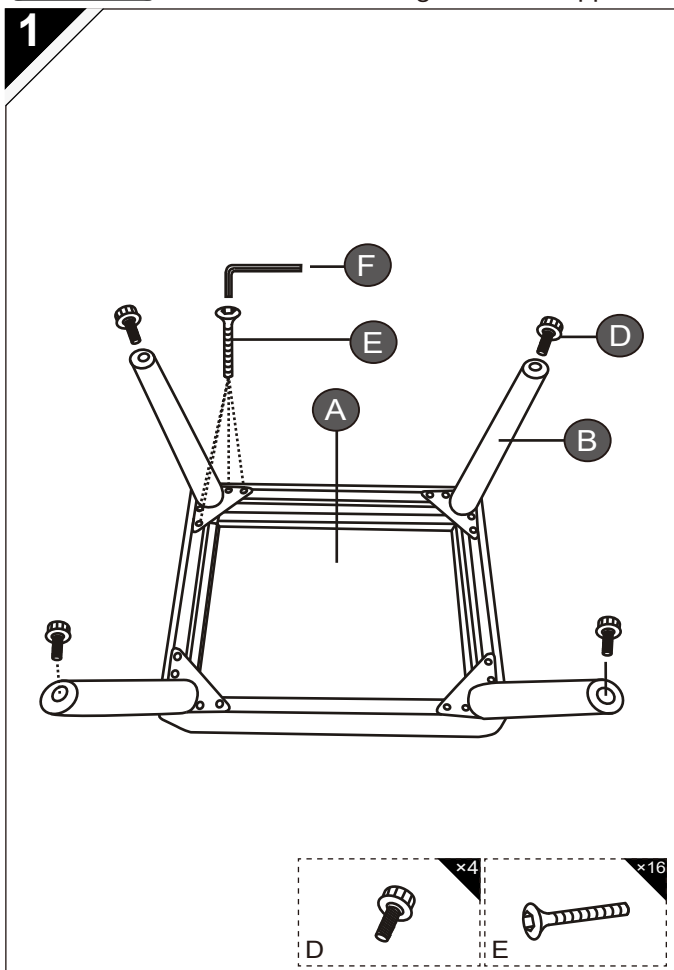

Contact person  
tectake Ltd  
18 Soho Square  
London W1D 3QL  
United Kingdom  
Telephone: +44 203 488 4565  
www.tectake.co.uk  
mail@tectake.co.uk

Persona de contacto  
Ibérica de Distribuciones  
online del Hogar,  
SLU,  
Méndez Álvaro 20,  
Madrid 28045,  
Teléfono: +34 912907933  
www.tectake.es  
correo electrónico: mail@idoh.es

Kontaktná osoba  
TecTake SLO d.o.o  
Nazorjeva ulica 6,1000 Ljubljana,  
Telefónne číslo: +386 30 745 150  
www.tectake.si  
E-Mail: mail@tectake.si

Ansprechpartner  
tectake GmbH  
Tauberweg 41  
97999 Igersheim  
Telefon: +49 7931 991 920  
www.tectake.de  
E-Mail: verkauf@tectake.de

Persona di contatto  
tenulodi S.r.l.  
Via Manzano 70  
33040 Premariacco (UD)  
Numero di telefono: +39 0471 1800175  
www.tectake.it  
E-Mail: mail@tectake.it

Personne de contact  
Made4Home SAS  
137 av. Gustave Eiffel  
ZI Rognac Nord  
13340 Rognac (France)  
téléphone au: +33 4 42 81 81 80  
www.tectake.fr  
E-Mail: contact@tectake.fr

Kontaktní osoba  
TecTake s.r.o.  
se sídlem na adrese Lidická 700 / 19, Veverí,  
602 00 Brno, Česká republika  
+420 538 880 441  
www.tectake.cz  
E-Mail: mail@tectake.cz

**RETAIN FOR FUTURE REFERENCE  
FÜR KÜNFTIGE VERWENDUNG AUFBEWAHREN  
A CONSERVER POUR UNE UTILISATION FUTURE  
CONSERVAR PARA SER LEÍDO POR CADA NUEVO USUARIO,  
ANTES DE UTILIZAR EL ARTÍCULO POR PRIMERA VEZ  
CONSERVARE PER CONSULTAZIONI FUTURE**