

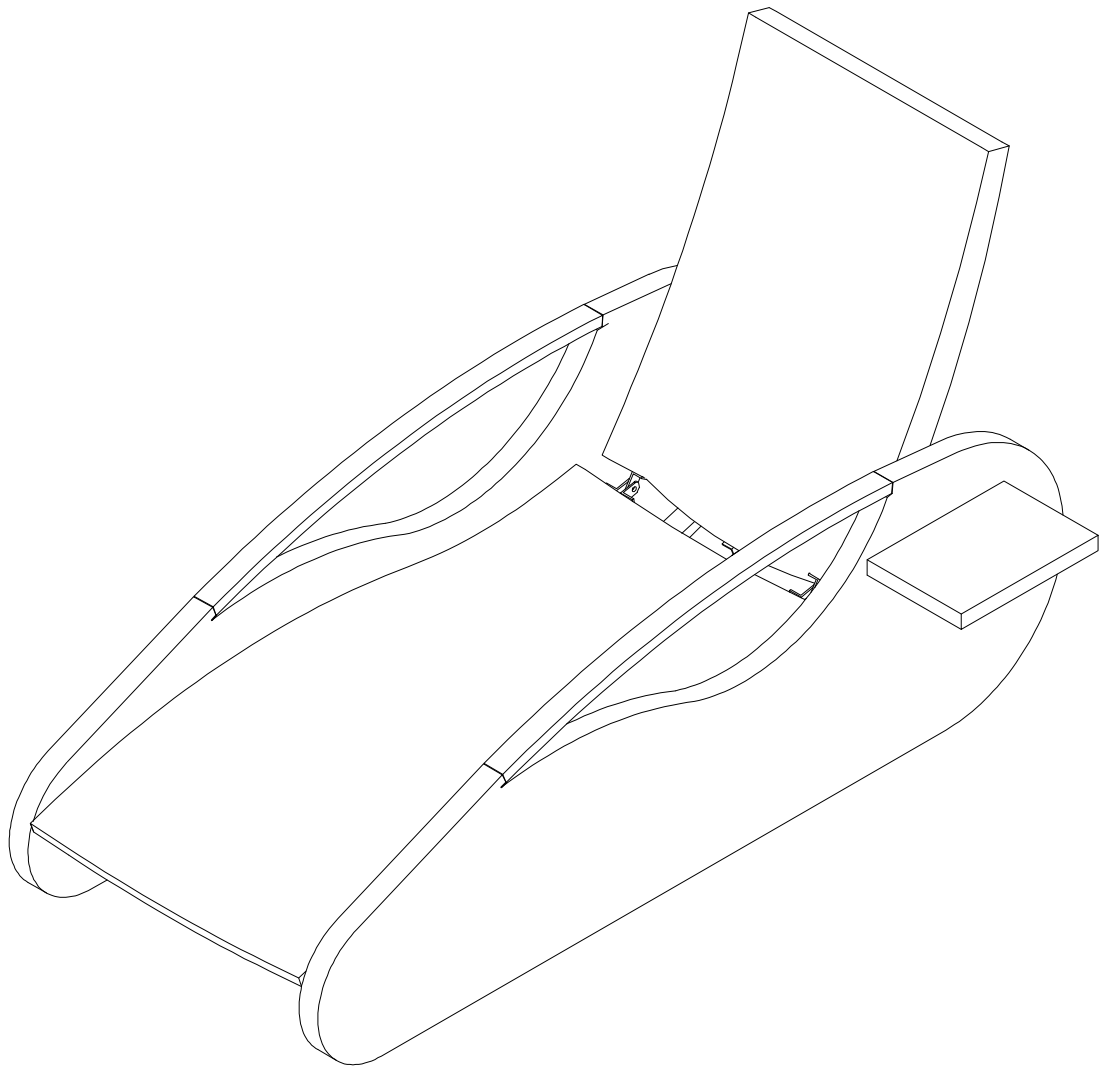

Art. 970359
Lounger ALASSIO

Aufbauanleitung

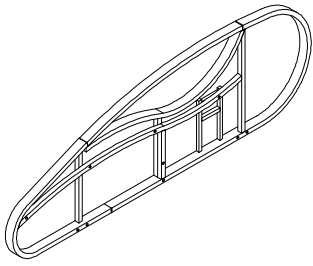



A*1

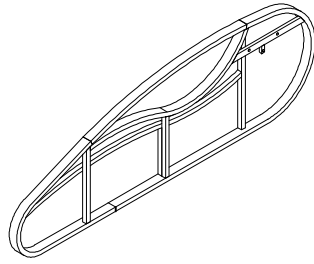

B*1

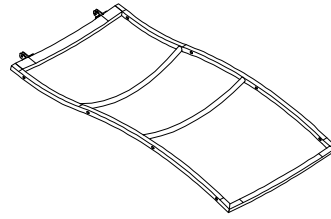

C*1

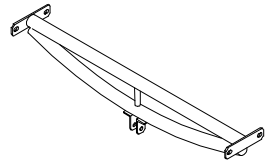

D*1

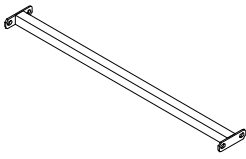

E*2

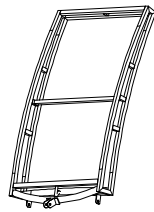

F*1

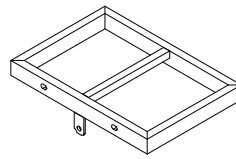

G*1

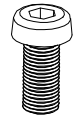

H*13
M6*15mm



I*2
M6*25mm

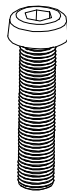

J*8
M6*35mm

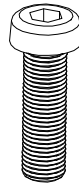

K*2
M8*25mm

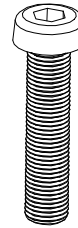

L*2
M8*35mm



M*23
Ø12*1.0mm



N*8
Ø18*1.0mm



O*4
M8



P*1
4*4mm

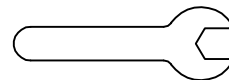



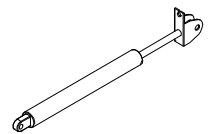

Q*1
M8

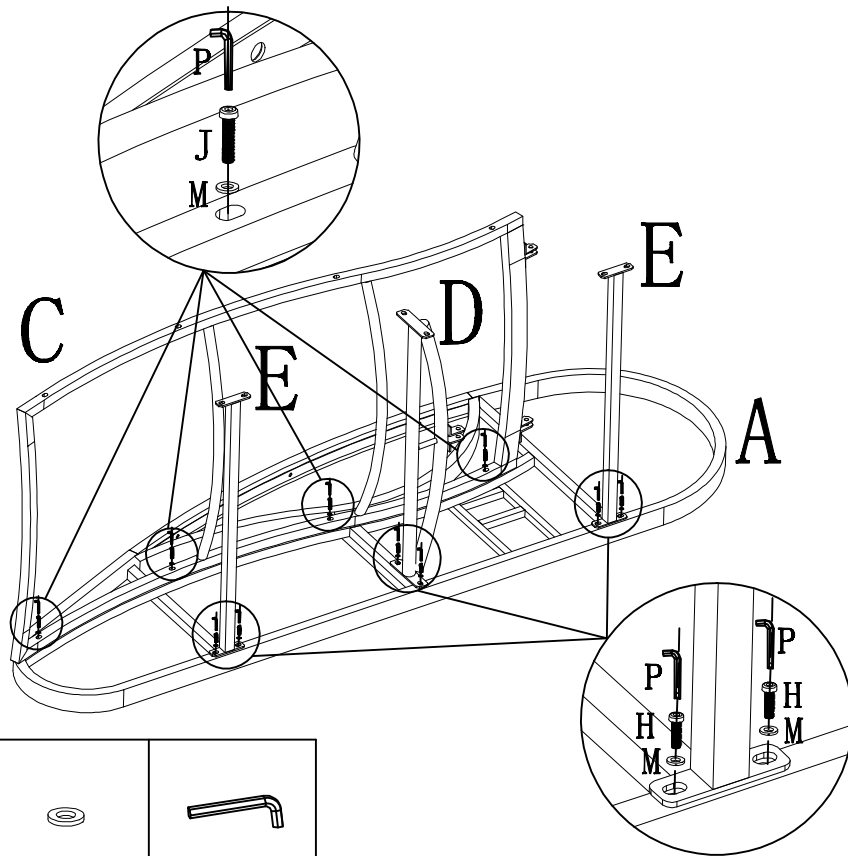

R*1





1

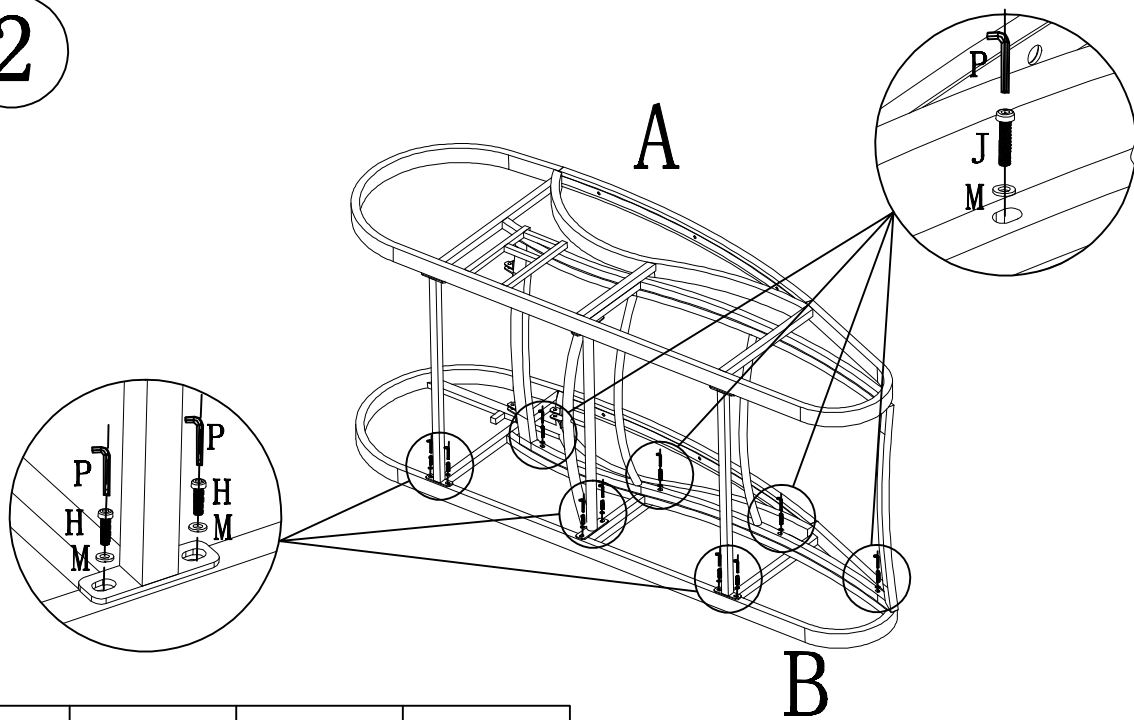

			
H*6 M6*15mm	J*4 M6*35mm	M*10 φ12*1.0mm	P*1 4*4mm





2

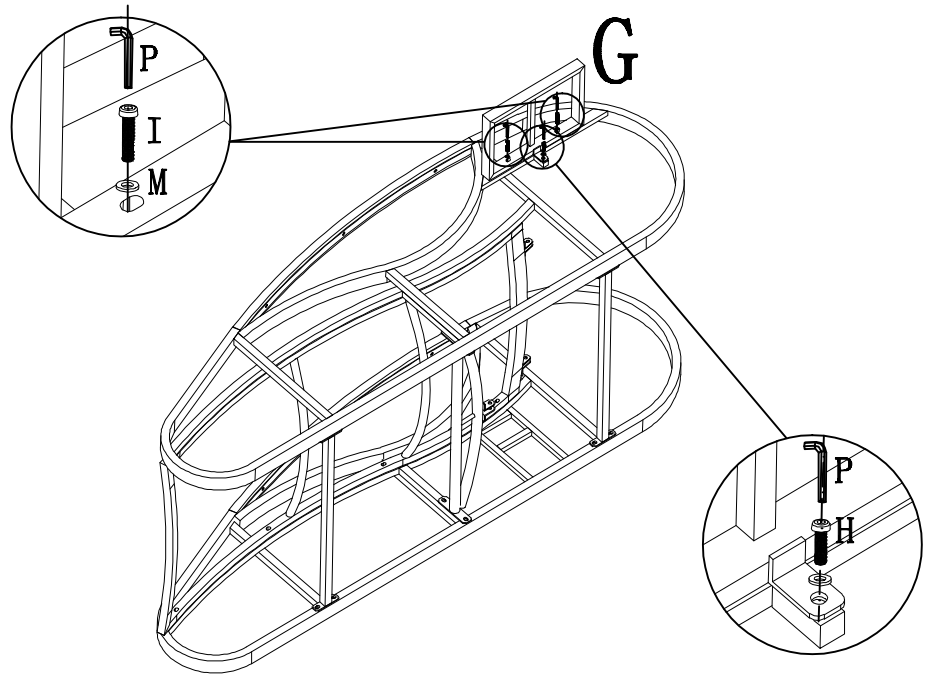

			
H*6 M6*15mm	J*4 M6*35mm	M*10 φ12*1.0mm	P*1 4*4mm





3

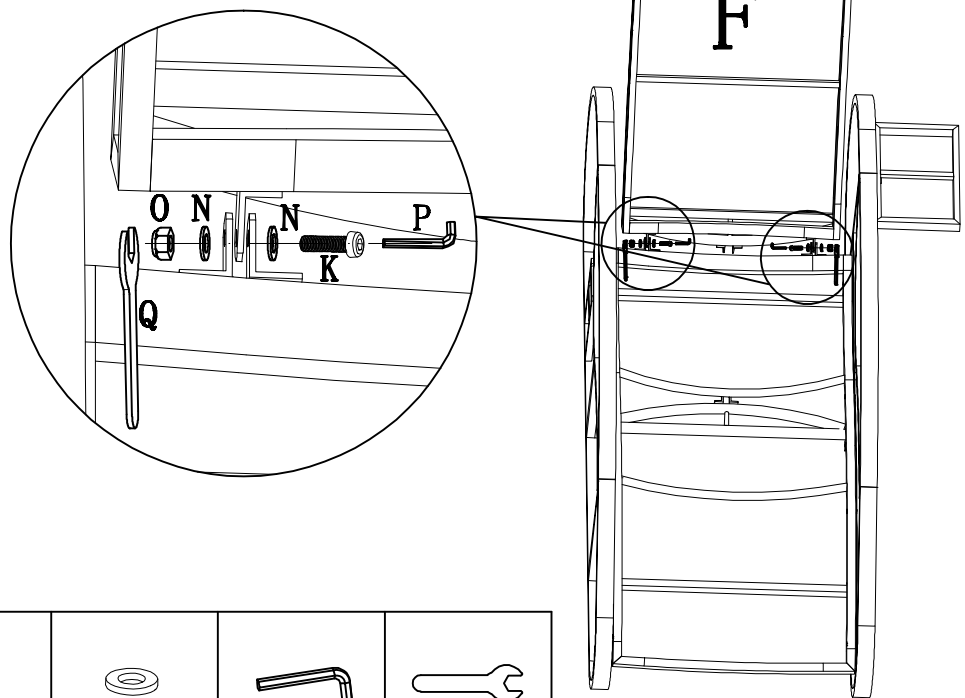

			
H*1 M6*15mm	I*2 M6*25mm	M*3 φ12*1.0mm	P*1 4*4mm

4

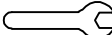

				
O*2 M8	K*2 M8*25mm	N*4 φ18*1.0mm	P*1 4*4mm	Q*1 M8

5

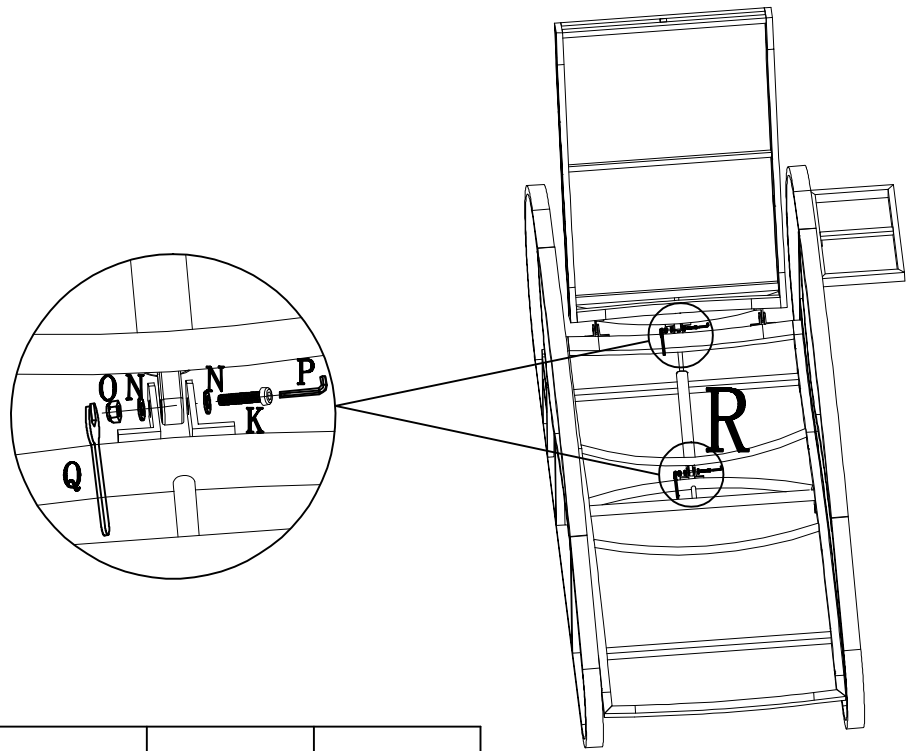

O*2
M8



L*2
M8*35mm



N*4
φ18*1.0mm

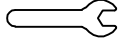

Q*1
M8

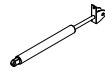

R*1

6

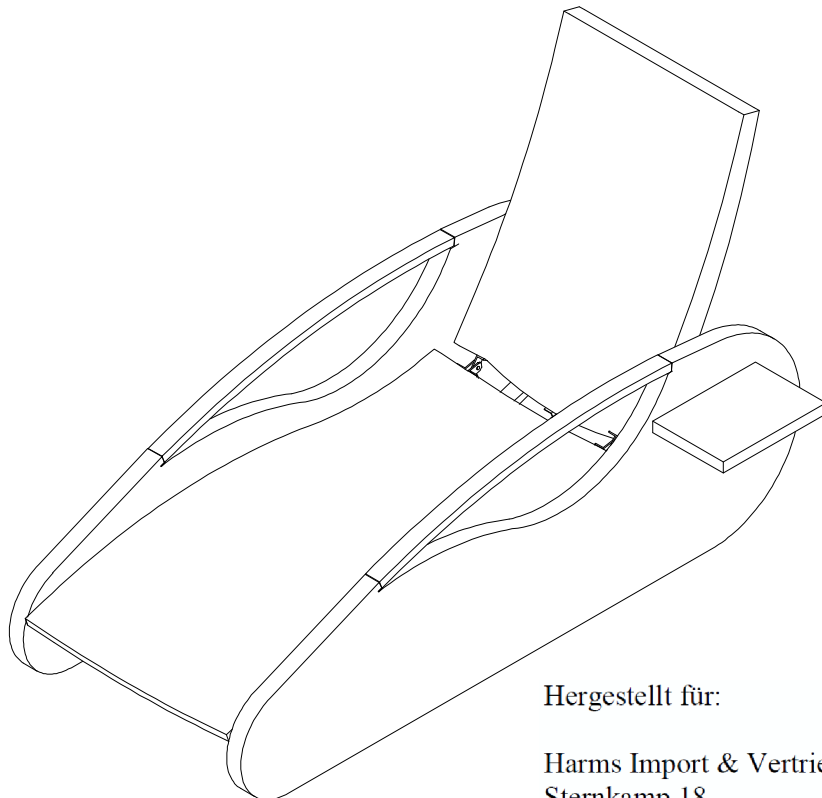

Hergestellt für:

Harms Import & Vertriebs GmbH & Co KG,
Sternkamp 18
D-26655 Westerstede