



(D) Videounterstützte Montageanleitung

(TR) Video destekli kurulum talimatları

(RU) инструкция по монтажу с помощью видеосигнала

(RO) Instrucțiuni de instalare acceptate video

(GB) Video-assisted assembly instructions

(IT) Istruzioni di montaggio video-assistite

(CZ) Instalační pokyny podporované videem

(PL) Instrukcje montażu wspomagane sygnałem wizyjnym

(FR) Instructions de montage assistées par vidéo

(NL) Video-ondersteunde montage-instructies

(HU) Video-támogatott telepítési utasítások

(SK) Inštaláčn  pokyny podporované videom

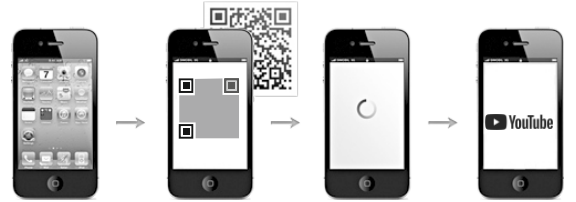
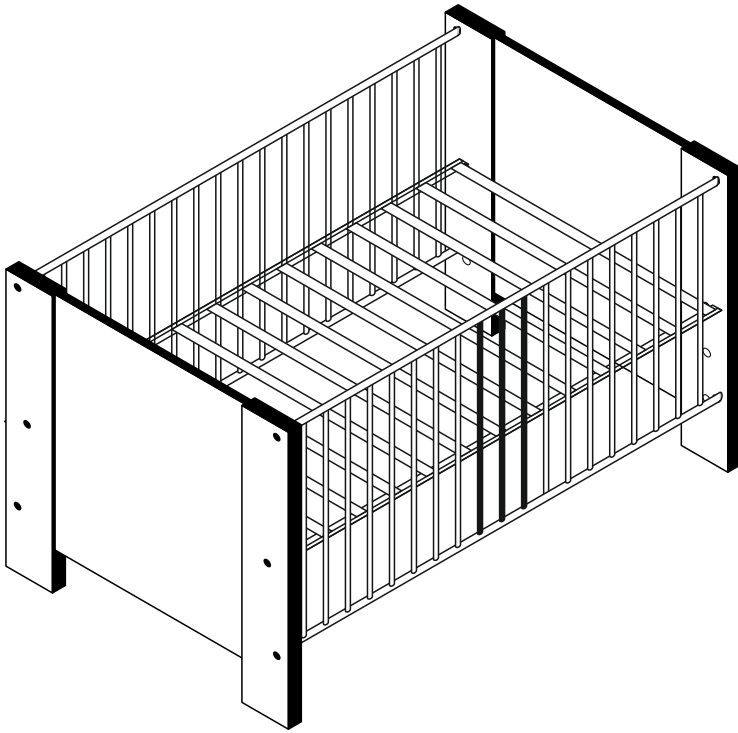

0447_BH-P1 Babybett





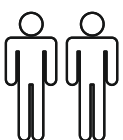
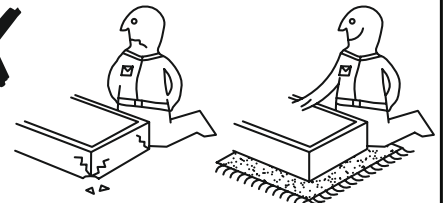
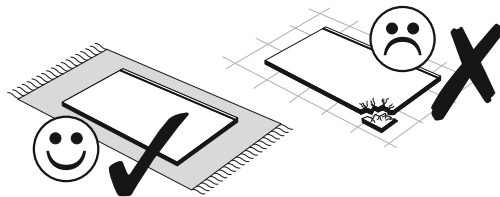
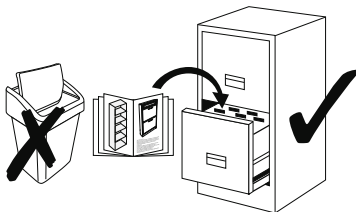
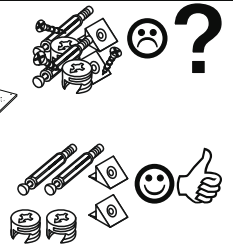
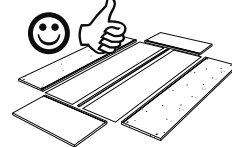
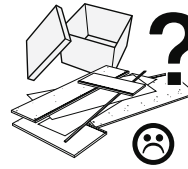
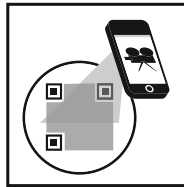
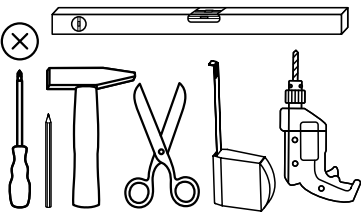

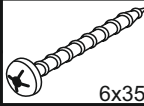

REPC-Nr.:

Service • Assistenza • Dienstverlening • Serwis
Servis • Szerviz • Сервисная служба

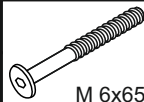

Das Ersatzteil-Anforderungsformular finden Sie auf <https://www.maeusbacher.de/ersatzteile/>

Beutel 1/1

1-179		1-330		1-333		2-100	
1x	6x35	32x	M4x10	16x		24x	6x55
10-10		10-15		5-130		10-05	
12x	M 6x65	1x		3x	LEIM	8x	Ø10/10

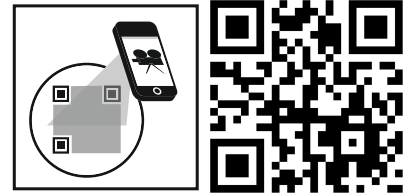

Colli 1/2

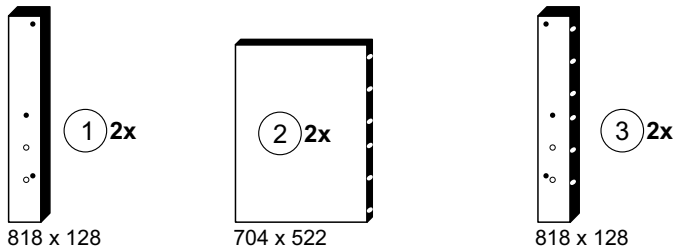
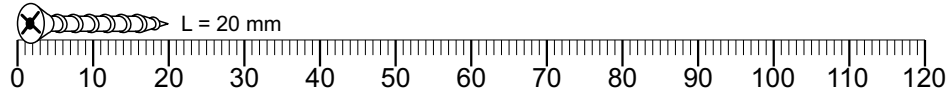

Colli 2/2

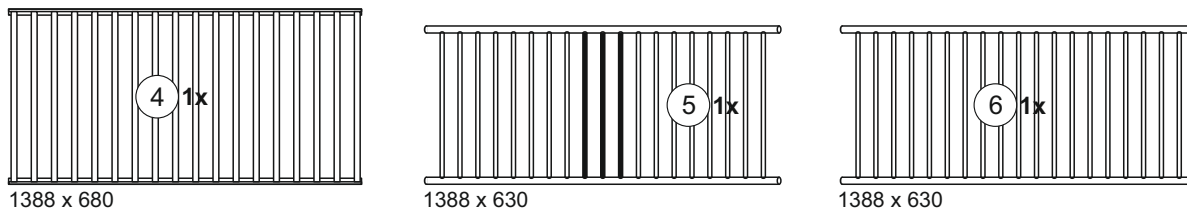

- (D)** Defekte Teile dürfen nicht in das Kinderbett eingebaut werden. Wenden Sie sich an den Hersteller um ein Ersatzteil anzufordern.
- (GB)** Faulty parts may not be fitted into the cot. Contact the manufacturer to request a replacement part.
- (FR)** Des pièces défectueuses ne doivent pas être utilisées pour le montage du lit d'enfants. Contactez le fabricant pour commander des pièces de rechange.
- (TR)** Hasarlı parçalar çocuk karyolasına takılmamalıdır. Bir yedek parçasını talep etmek için üreticiye danışın.
- (IT)** Non montare sul letto per bambini eventuali parti difettate. Rivolgersi al produttore e chiedere una sostituzione.
- (NL)** Defecte onderdelen mogen niet in het kinderbed worden ingebouwd. Neem contact op met de fabrikant voor vervanging van het onderdeel.
- (RU)** Устанавливать дефектные части в детскую кровать запрещено. Обратитесь за заменой к производителю.
- (CZ)** Vadné části se nesmí montovat do dětské postýlky. Obráťte se na výrobcu a vyžádejte si náhradní díl.
- (HU)** Hibás alkatrészeket nem szabad a gyermekágyba beszerelni. Forduljon ilyen esetben a gyártóhoz és kérje az alkatrész cseréjét.
- (RO)** Piesețe defecte nu pot fi sub nicio formă încorporate în patul copilului. Solicitați producătorului să vă expedieze piesa de schimb necesară.
- (PL)** Nigdy nie używaj uszkodzonych części do montażu łóżeczka. Skontaktuj się z producentem, by otrzymać części zamienne.
- (SK)** Do detskej postieľky sa nesmú namontovať poškodené diely. V prípade potreby náhradného dielu sa obráťte na svojho predajcu.

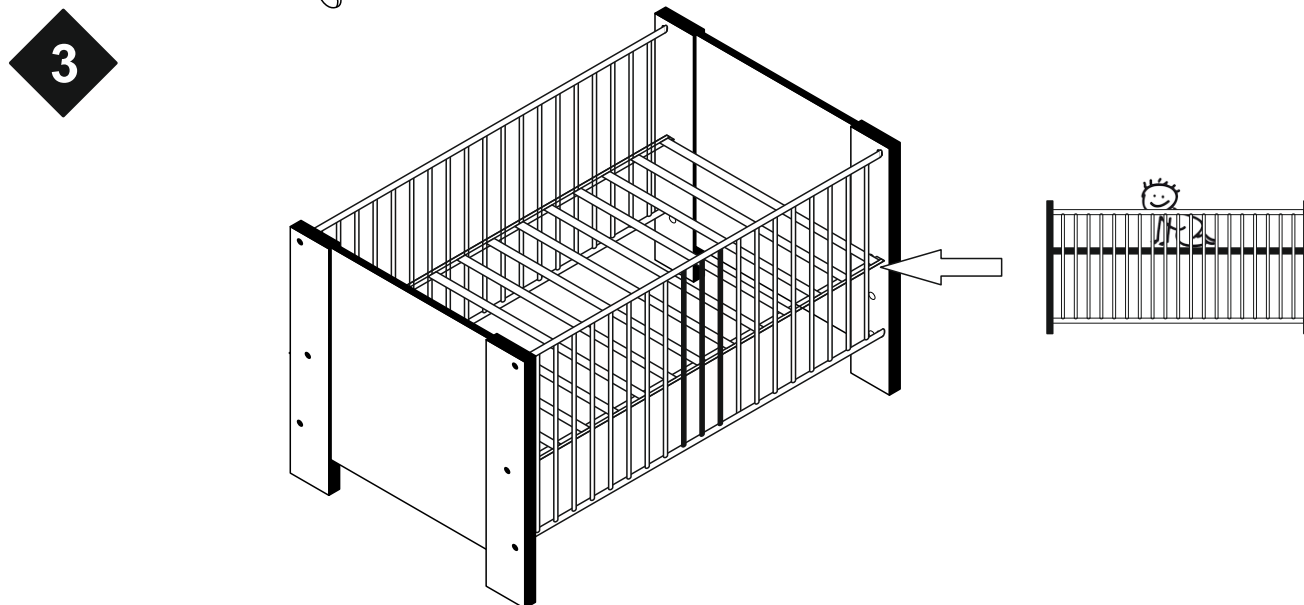
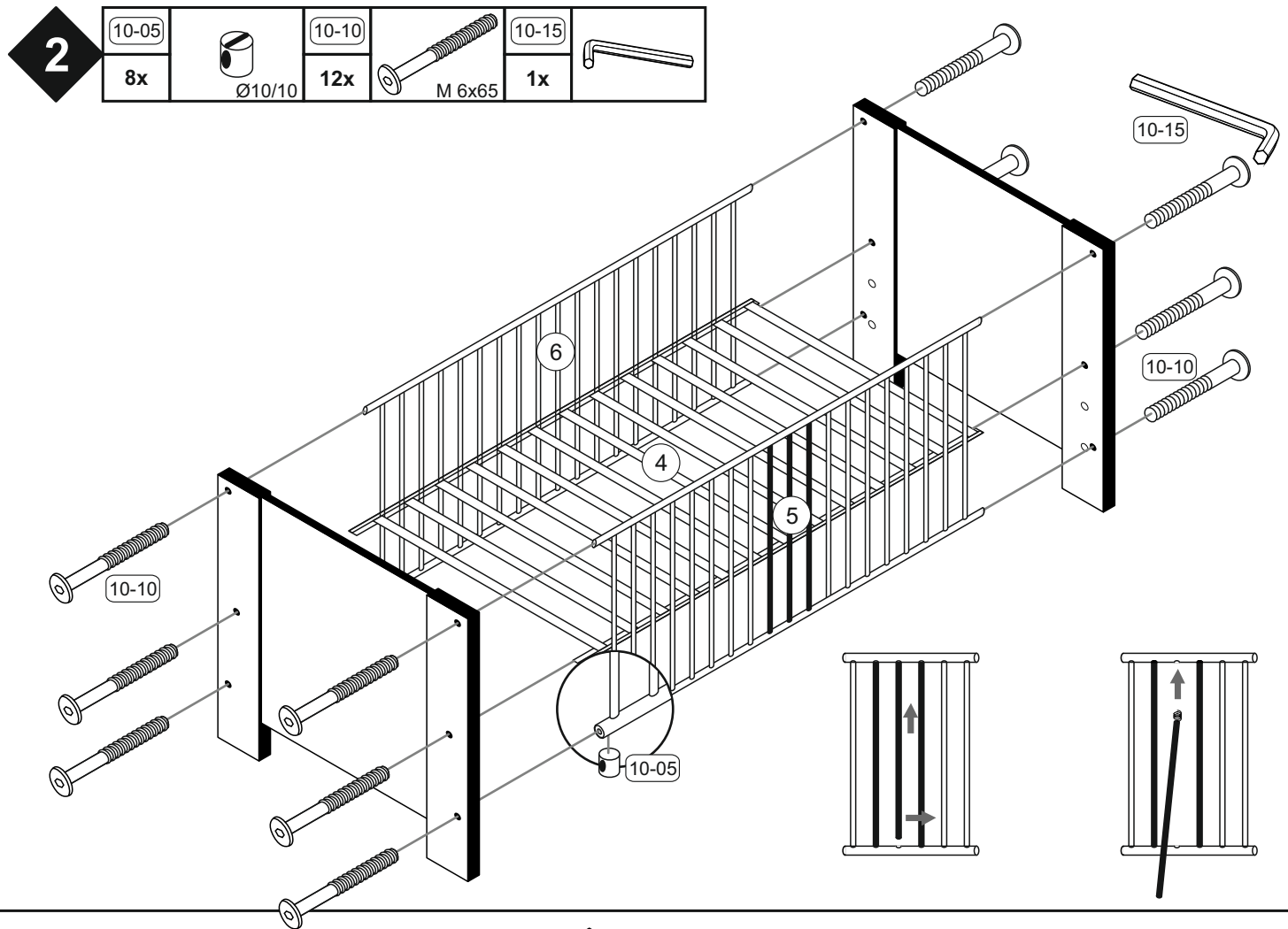
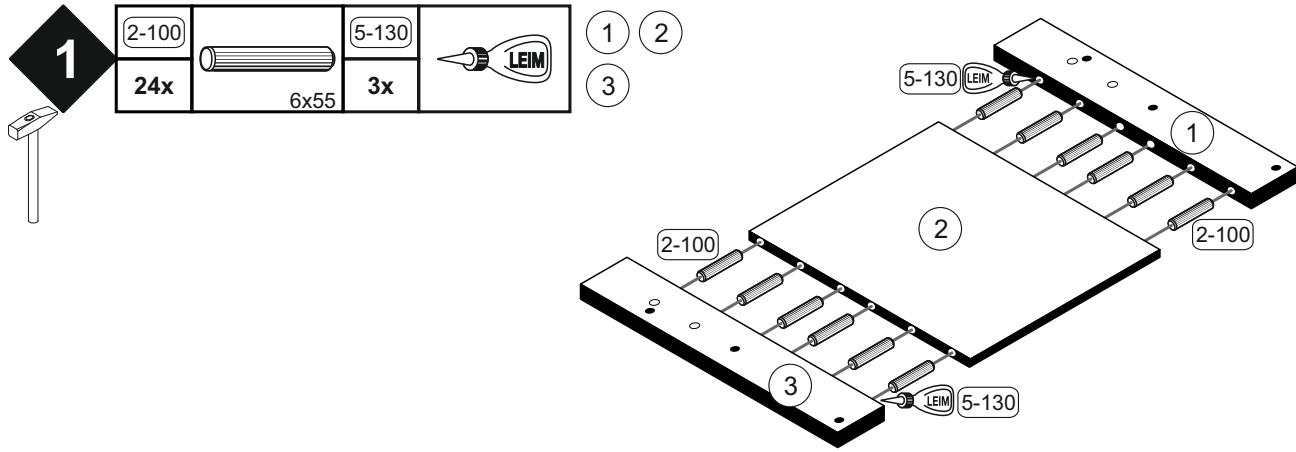

3.1



1-179		1-330		1-333	
1x	6x35	8x	M4x10	4x	

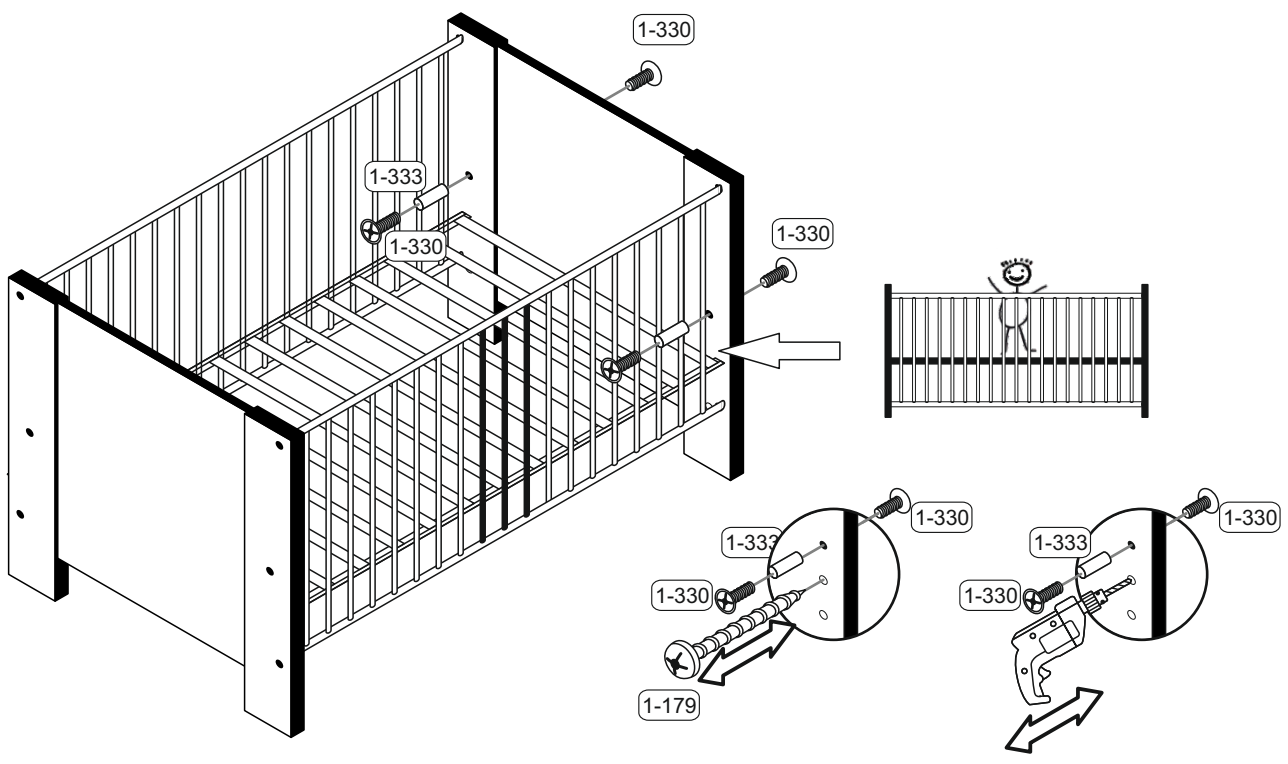

3.2



1-179		1-330		1-333	
1x	6x35	8x	M4x10	4x	

