



(D) Videounterstützte Montageanleitung

(TR) Video destekli kurulum talimatları

(RU) инструкция по монтажу с помощью видеосигнала

(RO) Instrucțiuni de instalare acceptate video

(GB) Video-assisted assembly instructions

(IT) Istruzioni di montaggio video-assistite

(CZ) Instalační pokyny podporované videem

(PL) Instrukcje montażu wspomagane sygnałem wizyjnym

(FR) Instructions de montage assistées par vidéo

(NL) Video-ondersteunde montage-instructies

(HU) Video-támogatott telepítési utasítások

(SK) Inštačné pokyny podporované videom

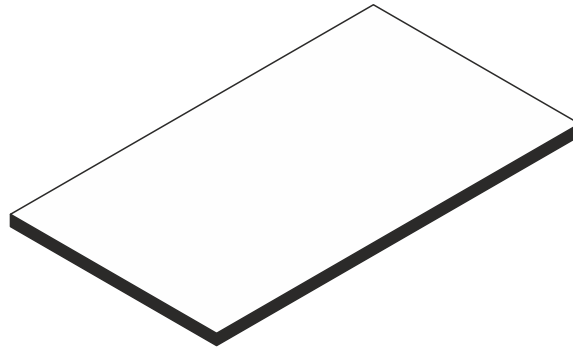
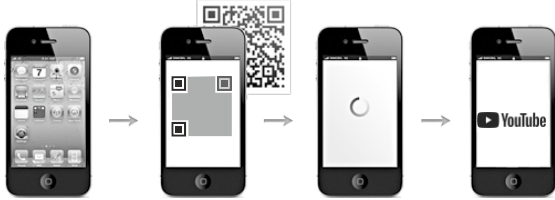

Art.Nr. : **0205\_120**

# Tischplatte 120

REPC-Nr.:

Service • Assistenza • Dienstverlening • Serwis  
Servis • Szerviz • Сервисная служба

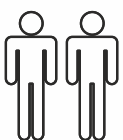
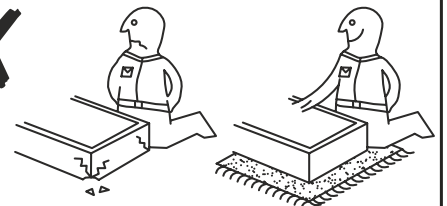
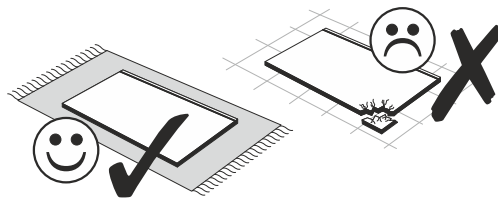
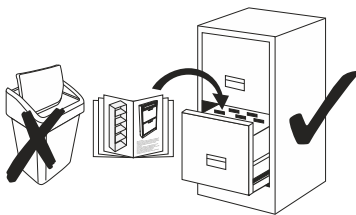
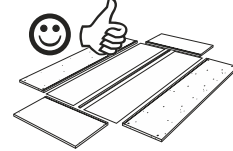
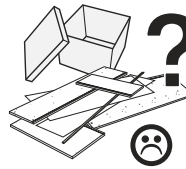
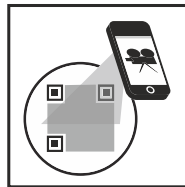
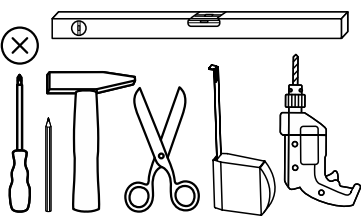

Colli 1/1: ④

# Colli 1/1



1200 x 700

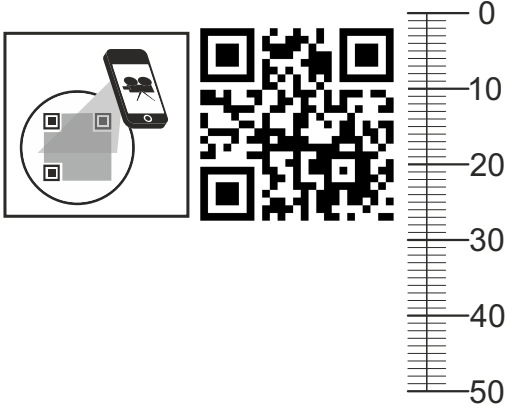



**D** Videounterstützte Montageanleitung

**TR** Video destekli kurulum talimatları

**RU** инструкция по монтажу с помощью видеосигнала

**RO** Instrucțiuni de instalare acceptate video

**GB** Video-assisted assembly instructions

**IT** Istruzioni di montaggio video-assistite

**CZ** Instalační pokyny podporované videem

**PL** Instrukcje montażu wspomagane sygnałem wizyjnym

**FR** Instructions de montage assistées par vidéo

**NL** Video-ondersteunde montage-instructies

**HU** Video-támogatott telepítési utasítások

**SK** Inštačné pokyny podporované videom

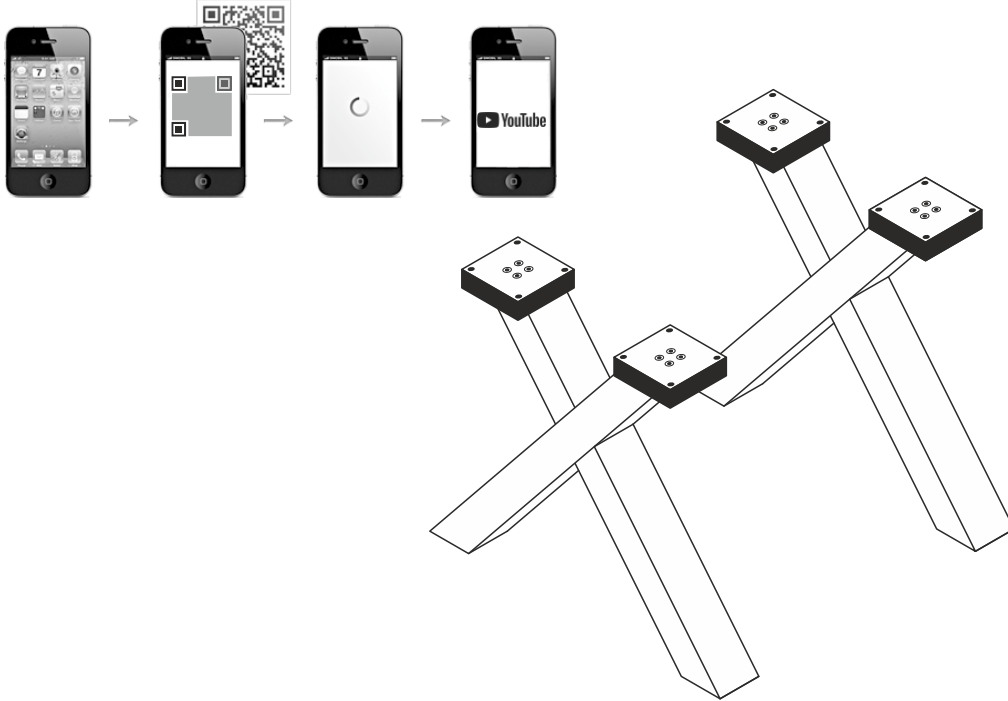

# 0205\_X-2er (zerl.) Untergestell/X

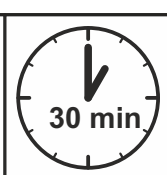
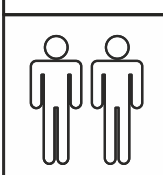
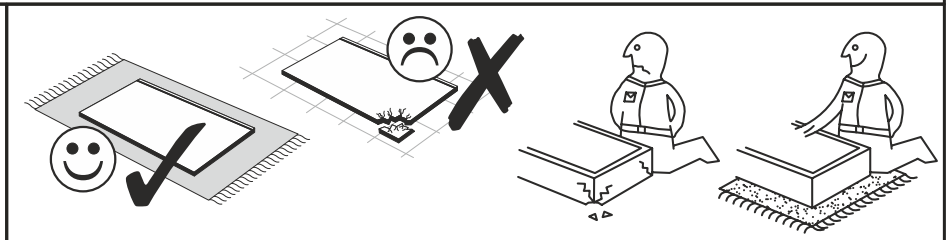
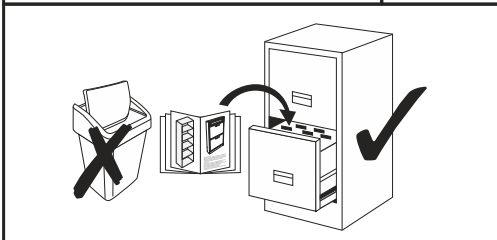

REPC-Nr.:

**Service • Assistenza • Dienstverlening • Serwis  
Servis • Szerviz • Сервисная служба**

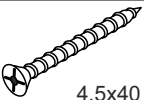
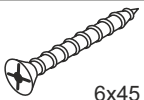

Colli 1/1: ① ② ③ Beutel 1/2, 2/2

## Beutel 1/2

1-172		1-180		2-104		5-130	
16x	4.5x40	16x	6x45	6x	8x40	2x	

## Beutel 2/2

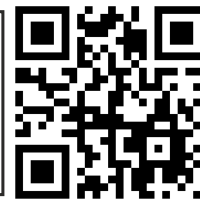
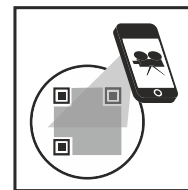

2-166	
16x	

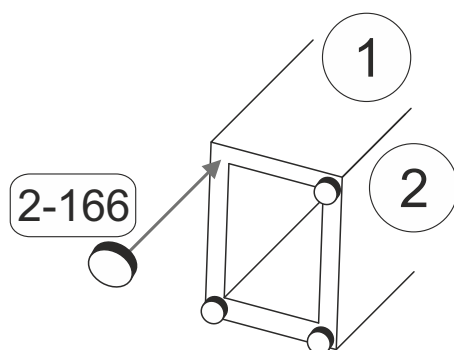
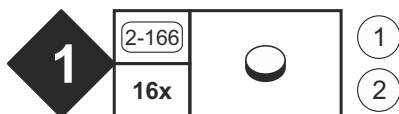
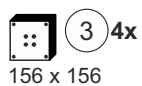
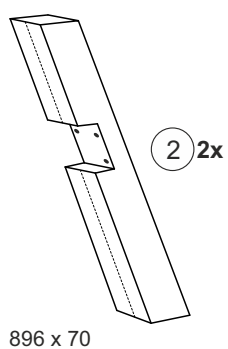
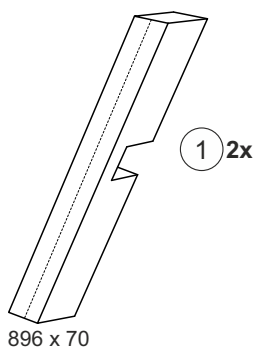

## Colli 1/1



**2**

2-104		5-130	
6x	8x40	1x	

2

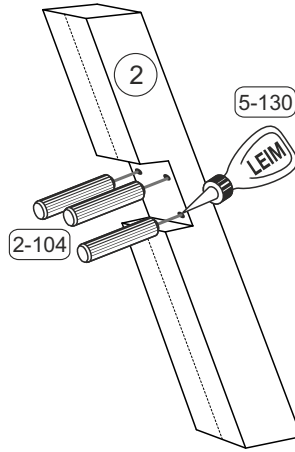

**3**

5-130		1
1x		2

1

2

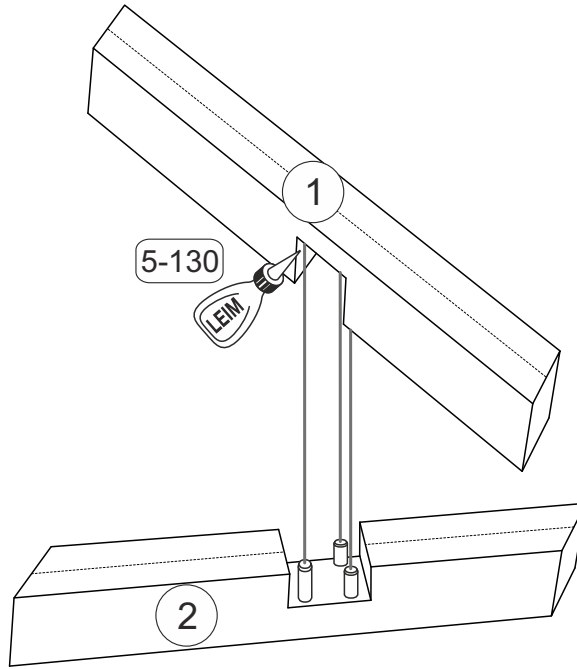

**4**