

Micro

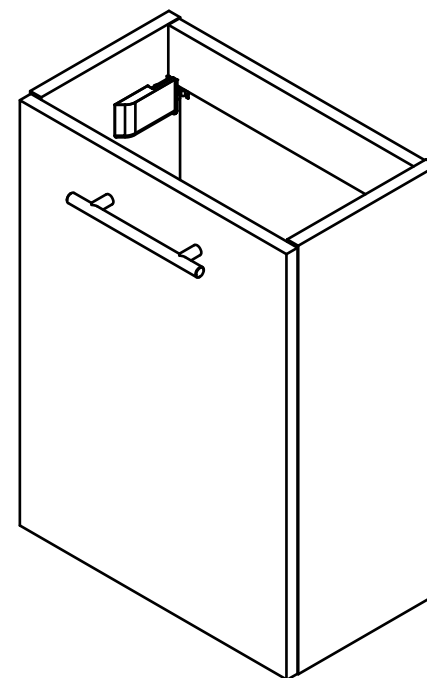

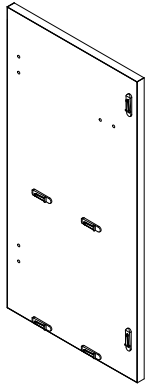

P001
X1

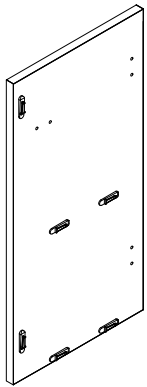

P002
X1

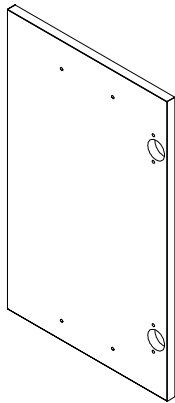

P003
X1

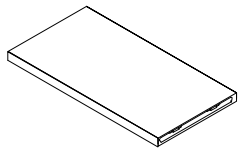

P004
X2

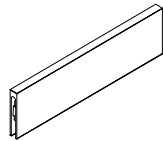

P005
X2

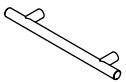

P006
X1



P007
X2



P008
X2



P009
X1



P010
X1



P011
X1



P012
X1



H001
X2



H002
X4



H003
X4



H004
X2



H005
X6



H006
X4

