





BAUANLEITUNG

TIPS

1. Please read the instructions fully before assembly. These instructions include important information which could ensure correct assembly. We have been working on providing high quality products for you. However, in the rare instance that your product is defective, missing parts or there are some issues, please don't hesitate to contact our customer service to submit parts requirements, assembly suggestion, or warranty claims, and we will give the best solution as soon as possible. If necessary, we need you to provide some more clear pictures of the issue.
2. Insert the screws in holes and tighten the screws, but not too tight, 70%~80% is ok, finally tighten all the screws. If some issues happened that some screws can not target to the hole or some parts are difficult to install, please adjust the tightness of the screws.
3. 2 people are recommended to finish.

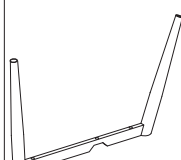
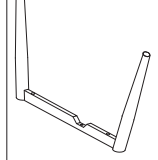

TIPPS

1. Bitte lesen Sie die Anweisungen vollständig, bevor Sie Montage. Diese Anweisungen enthalten wichtige Informationen, die eine korrekte Montage gewährleisten könnten. Wir haben an der Bereitstellung hoher Qualität gearbeitet Produkte für Sie. Im seltenen Fall dass Ihr Produkt defekt ist, Teile fehlen oder Es gibt einige Probleme, bitte zögern Sie nicht Kontaktieren Sie unseren Kundenservice, um Teile einzureichen Anforderungen, Montagevorschlag oder Garantie Ansprüche, und wir geben die beste Lösung so schnell wie möglich wie möglich. Bei Bedarf benötigen wir von Ihnen einige deutlichere Bilder der Ausgabe.
2. Insert die Schrauben in Löcher und ziehen Sie die Schrauben, aber nicht zu fest, 70%~80% ist ok, schließlich Alle Schrauben anziehen. Wenn einige Probleme aufgetreten sind dass einige Schrauben nicht auf das Loch zielen können oder Einige Teile sind schwierig zu installieren, bitte justieren die Dichtigkeit der Schrauben.
3. 2 Personen werden empfohlen, zu beenden.

A  1PCS	B  1PCS	C  1PCS	D  5PCS 6X45mm (spare1)	E  6PCS 6X18mm (spare1)
			F  2PCS 6X25mm (spare1)	G  1PCS

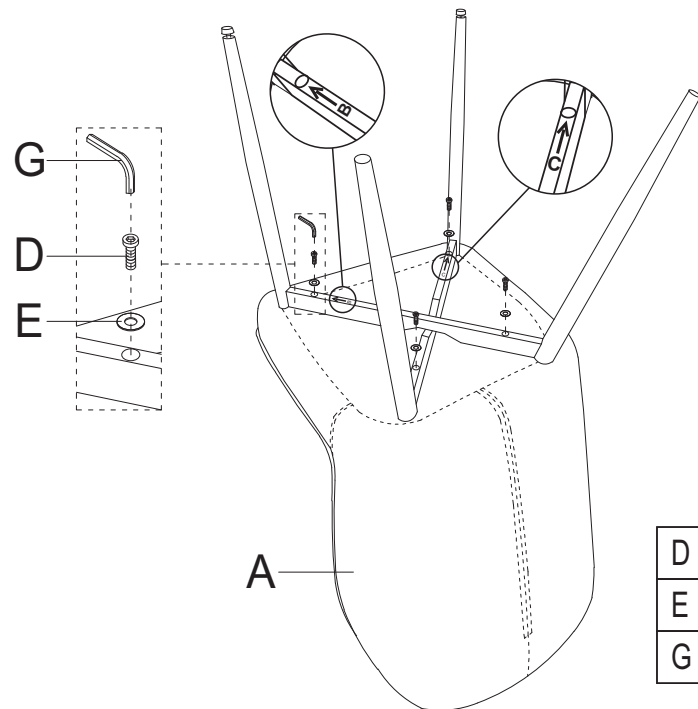

2

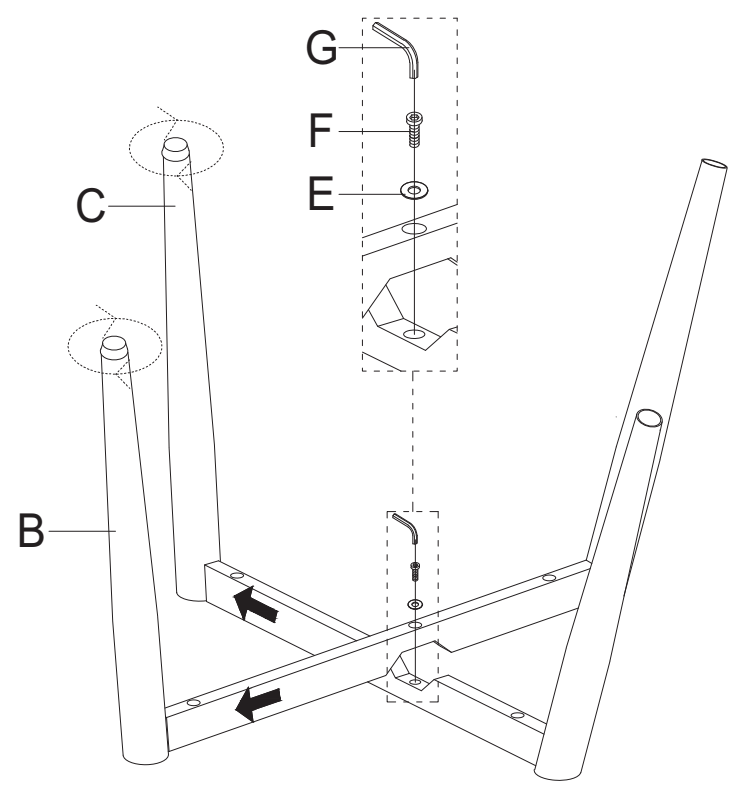

D	 6X45mm	4
E	 6X18mm	4
G		1

1



E	 6X18mm	1
F	 6X25mm	1
G		1

3

