

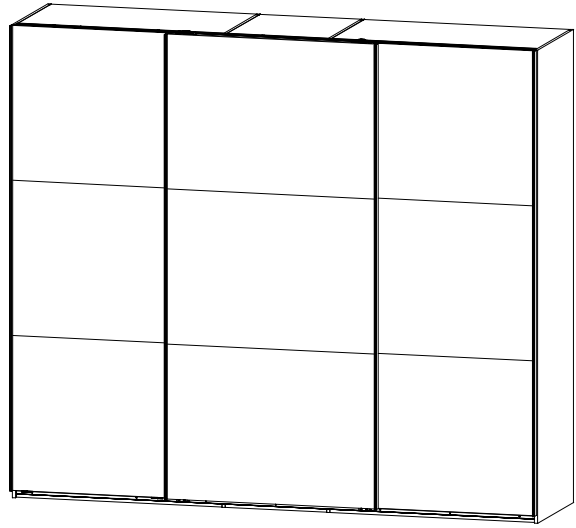

980717

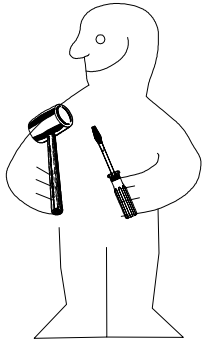

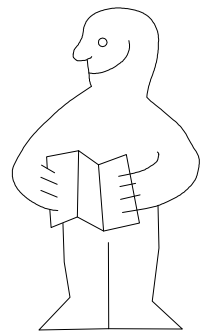

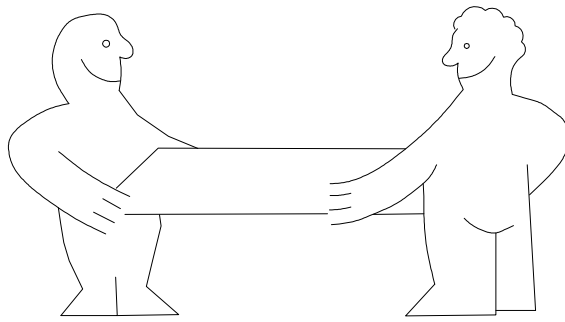
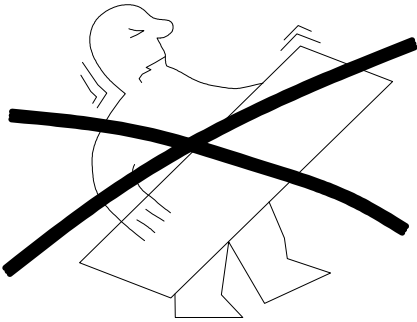



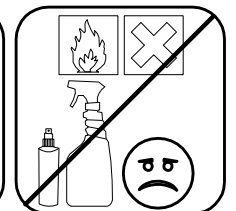
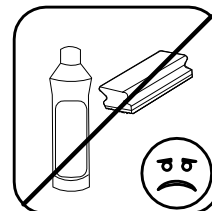
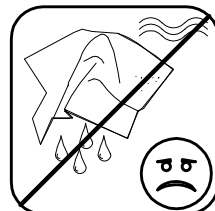
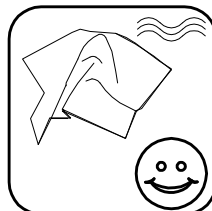
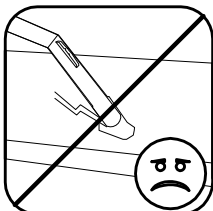
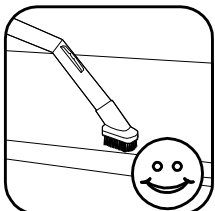
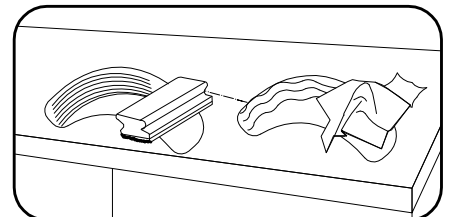
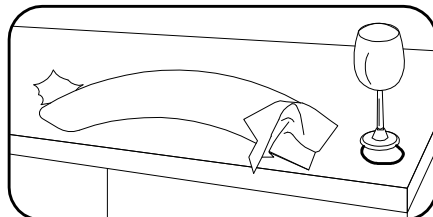
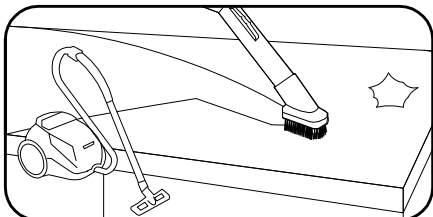
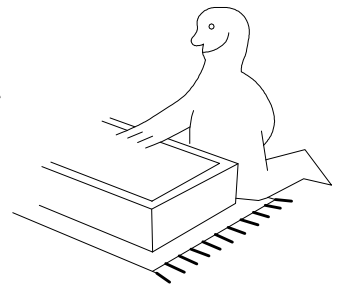
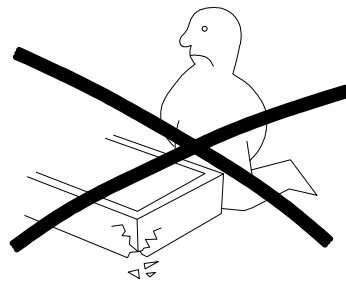
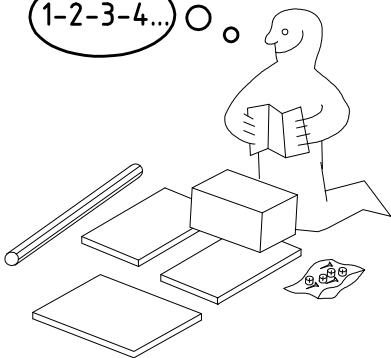

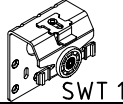
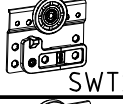
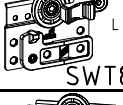
HSP 250 3trg 3tlg

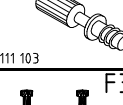



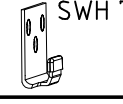
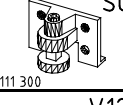

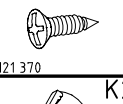
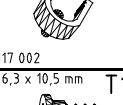
1-2-3-4... ○ ○

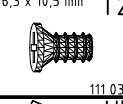

 SWT 1	2x
 SWT 2	2x
 SWT 8	1x
 SWT 9	1x
 A1	24x
 C	8x
 F3	8x

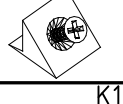
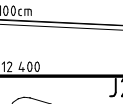
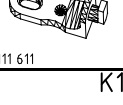
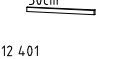
 SWH 6	2x
 SWH 7	4x
 S0	14x
 V12	14x
 G1	44x
 K2	6x
 T1	38x

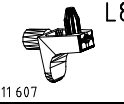
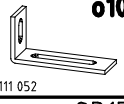

 4 X 13mm SP13	102x
 6,3 x 10,5 mm T2	42x
 H5	6x
 SBV	20x
 K10	2x
 J2	10x
 K11	1x

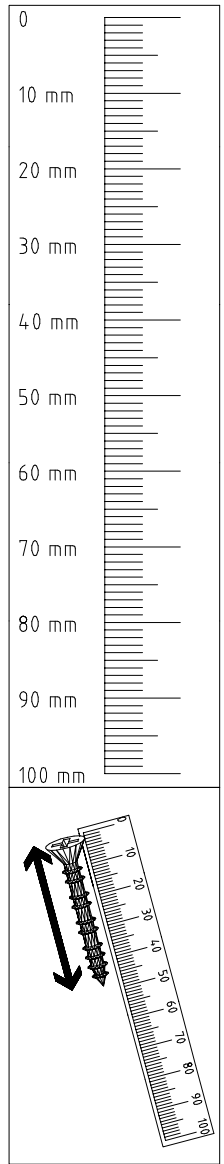
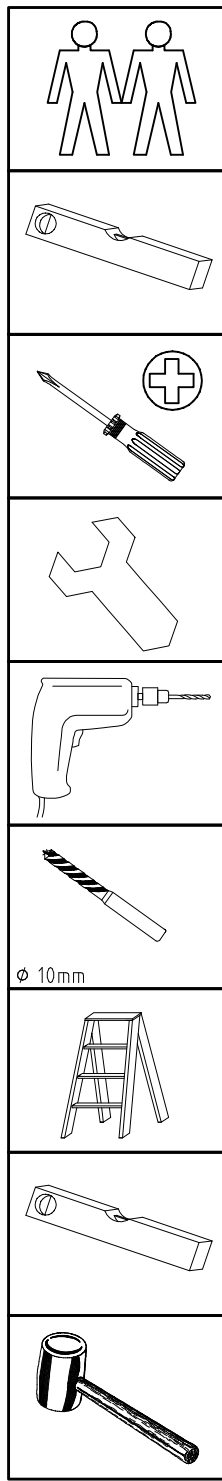

 L8	12x
 o10	1x
 4 X 15mm SP15	3x

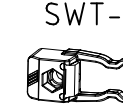
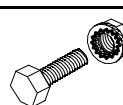
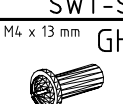
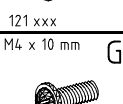

1x **FPK**
1453/1940/2430/2920/3408

1x **SWT-LP**
1453/1940/2430/2920
/3410 SY

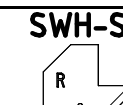
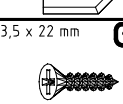
 SWT-ST	2x
 SWT-SM5	2x
 M4 x 13 mm GH13	6x
 M4 x 10 mm G43	6x
 3,5 x 35 mm G14	4x

 SWH-SKL	1x
 SWH-SKR	1x
 3,5 x 22 mm G24	9x
 SW-STM	1x

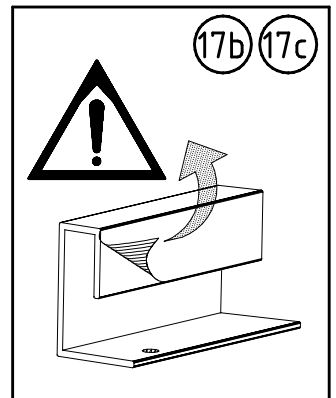
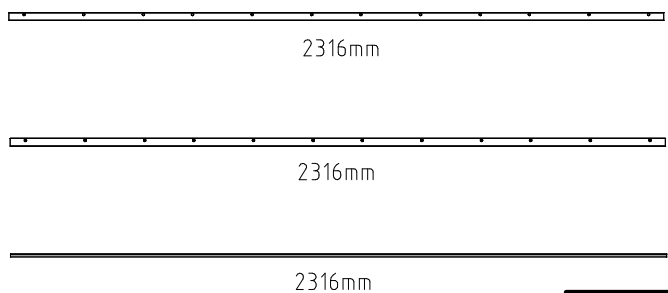
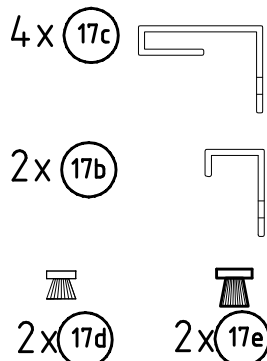

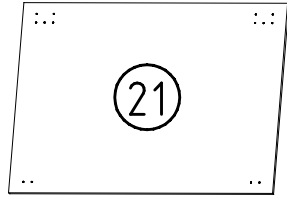
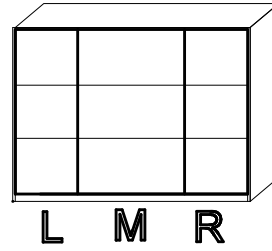
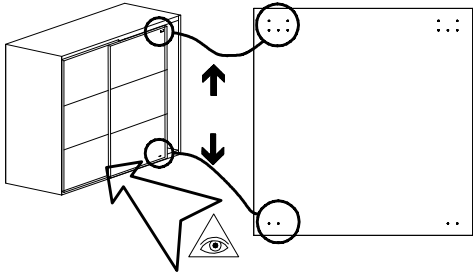

3x 990 x 708 x 15

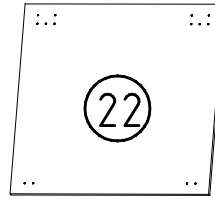

6x 745 x 708 x 15

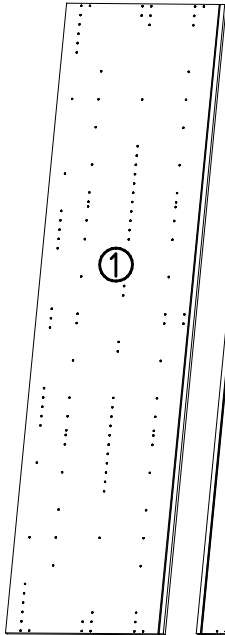

2160x577x15

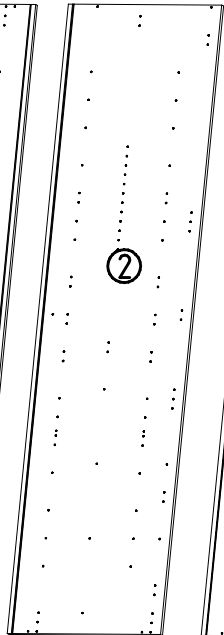

2x 2160x560x15

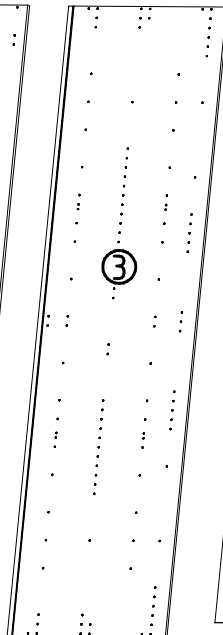

2160x577x15

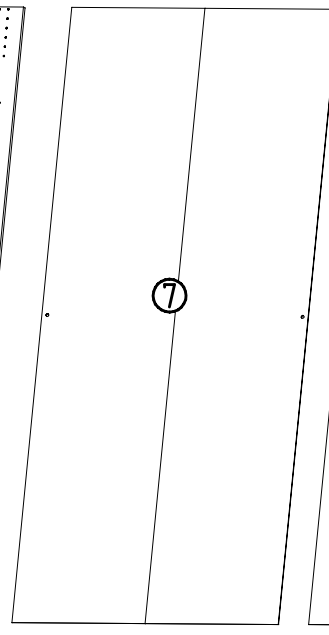

2x 2111x973x2,5

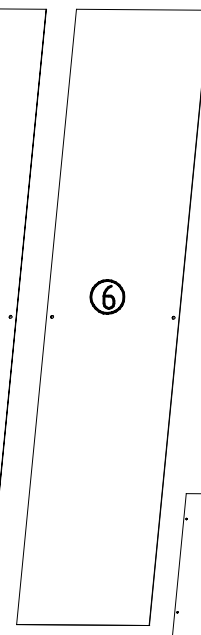

2111x484x2,5

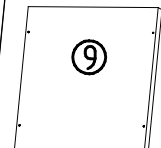

475x500x18

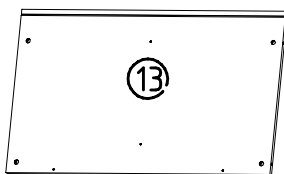

2x 964x560x15

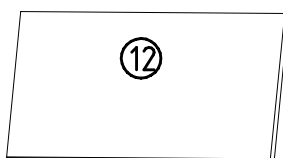

2x 964x500x18

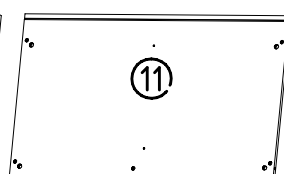

2x 964x560x47

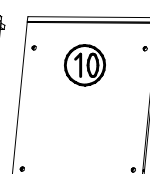

475x560x15

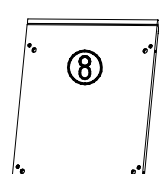

475x560x47

1

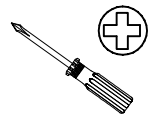
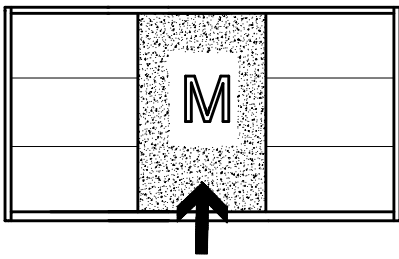

SP13
4 X 13mm
121 122

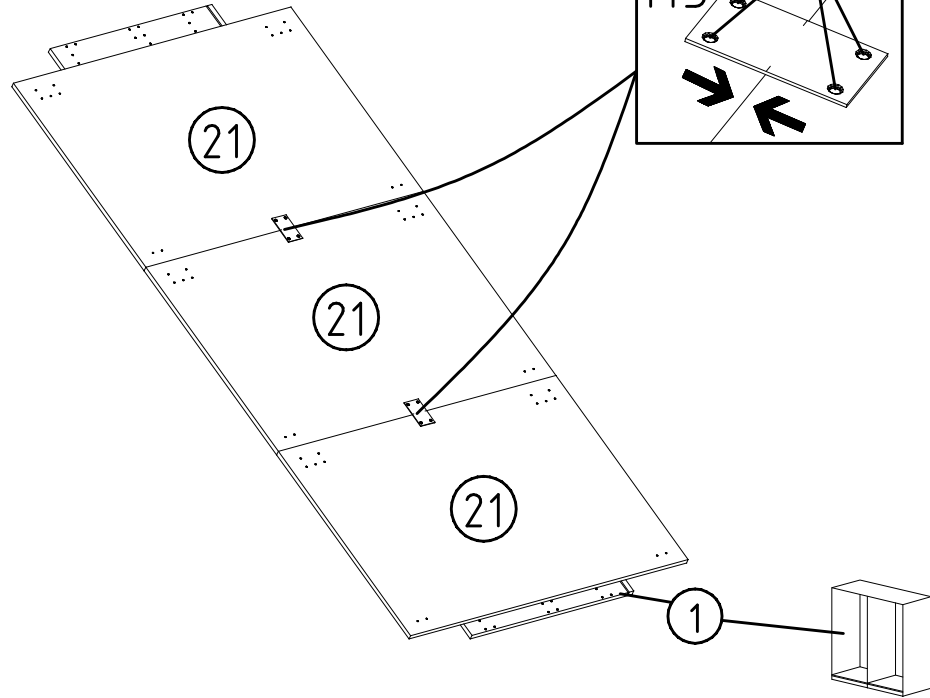
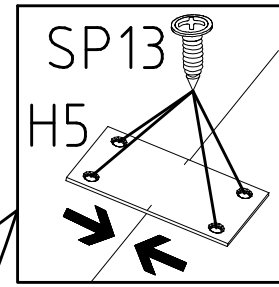

2

SP13
4 X 13mm
121 122

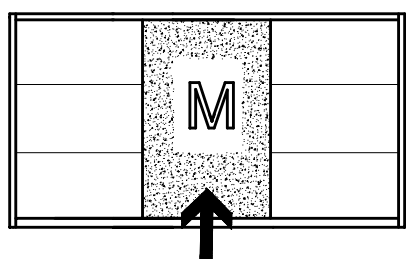
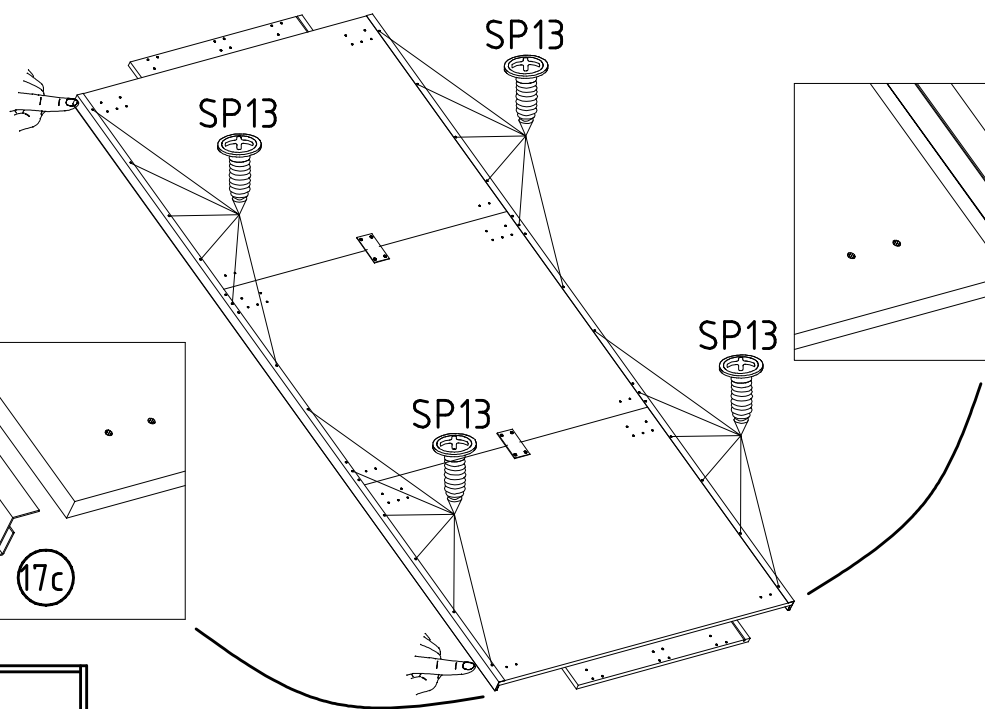
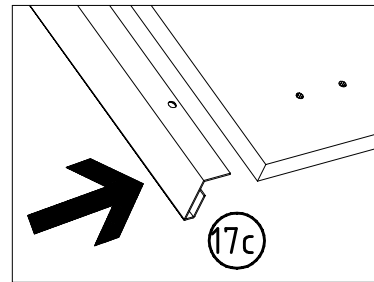
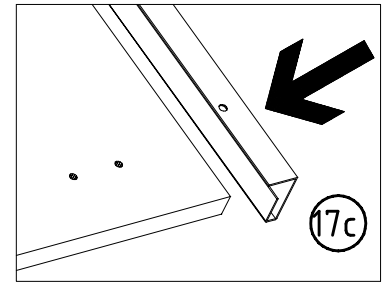
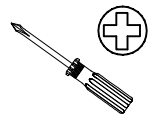

2x 17c

3

4 X 13mm SP13



121 122

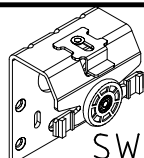

SWT 1

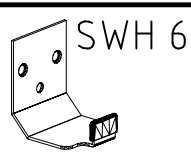

SWH 6

6,3 x 10,5 mm T2

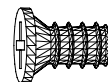

111 030

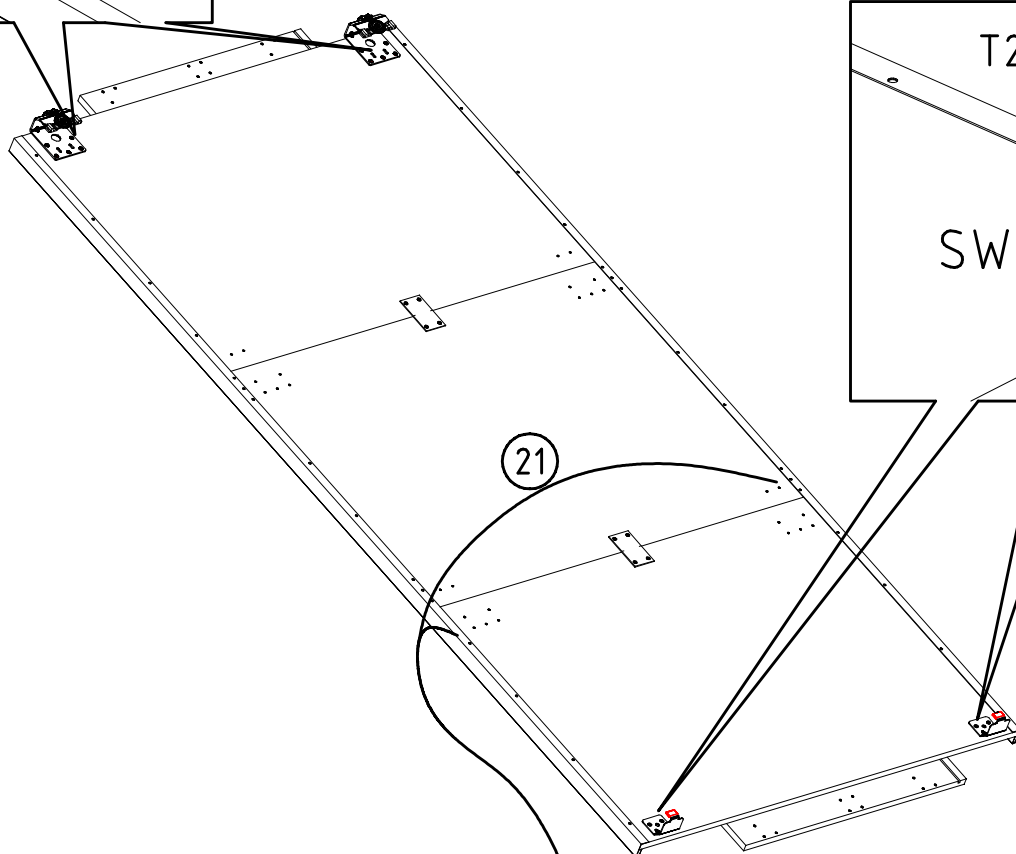
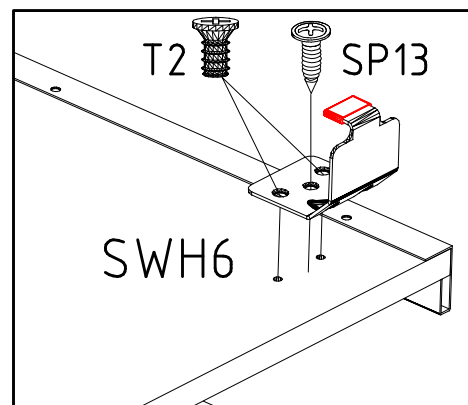
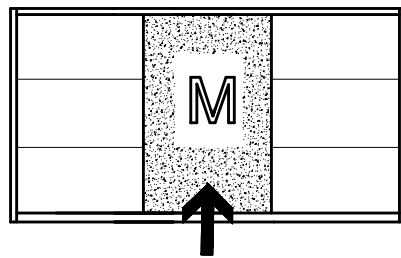
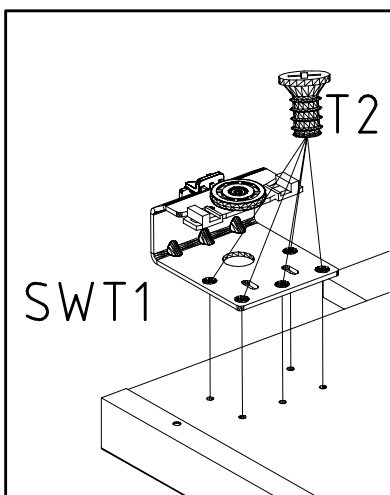
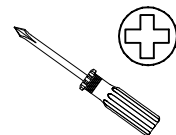

21

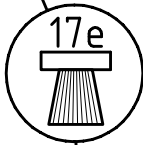

17e

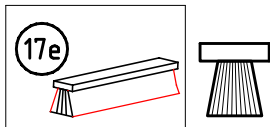

17e

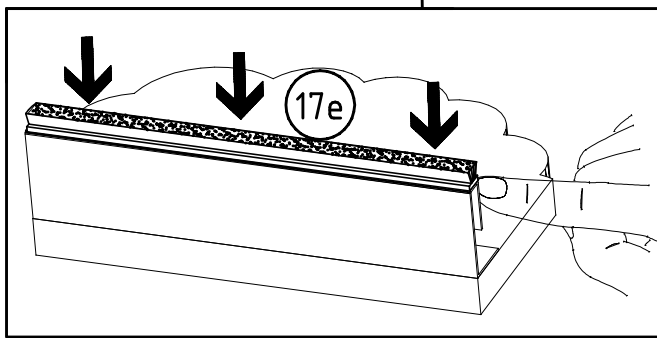
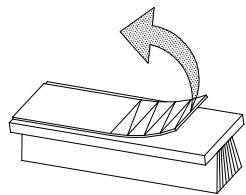

17e

4

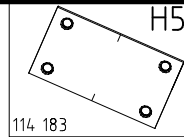
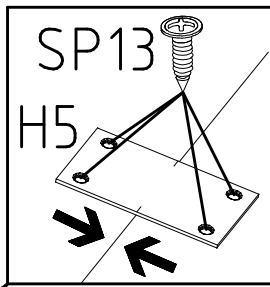
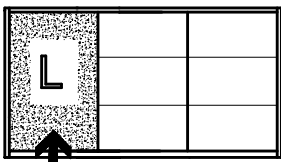

4 X 13mm
SP13
121 122

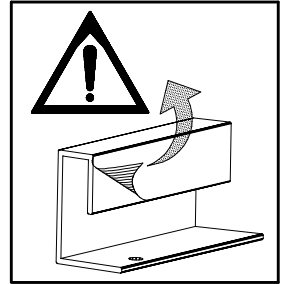
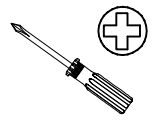

1

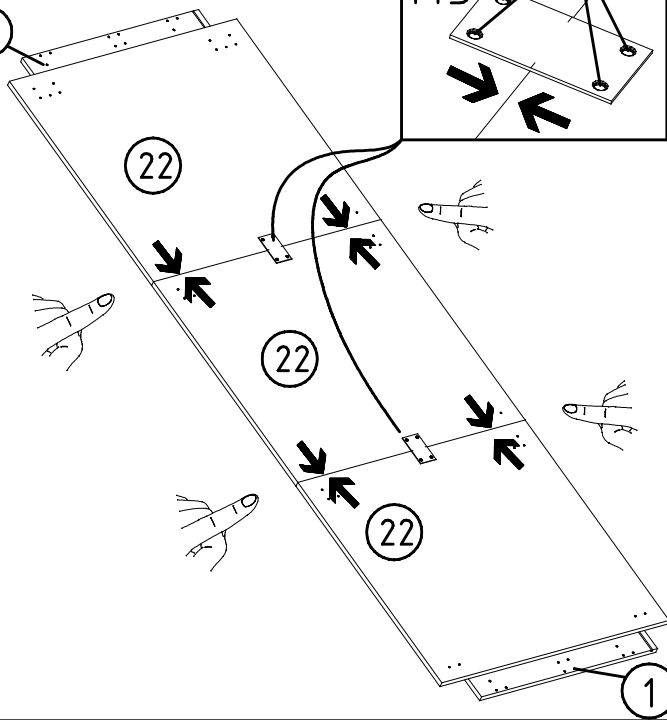

17b

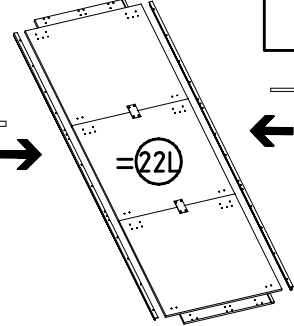

17c

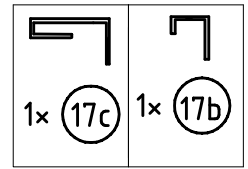

5

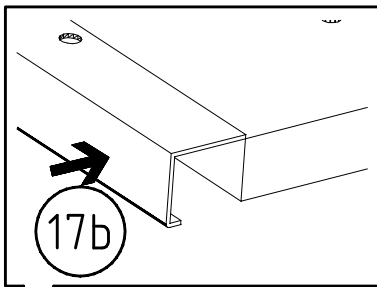

4 X 13mm
SP13
121 122

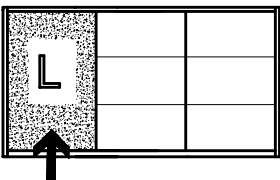
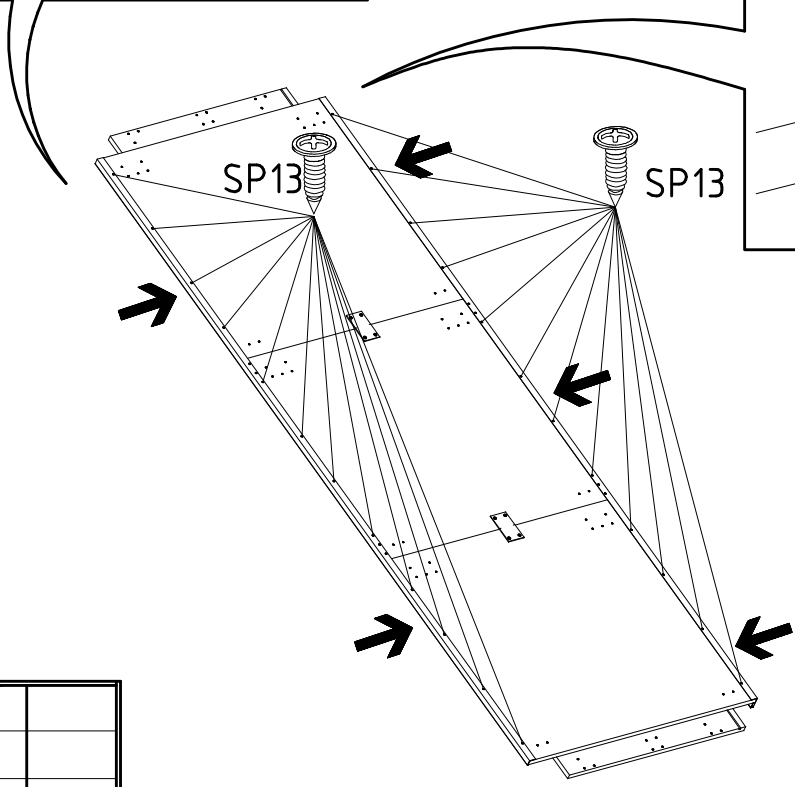
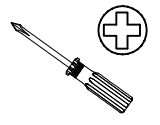

6

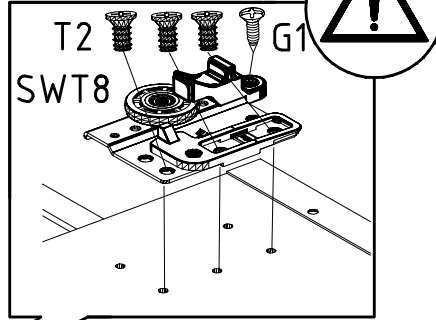
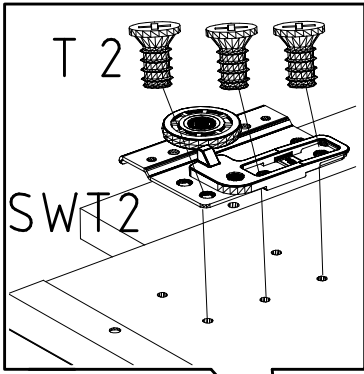

SWT2	SWT8
6,3 x 10,5 mm T2	SWH 7
111 030	
3,5 x 15 mm G1	SP13
	4 X 13mm
121 370	
	121 122

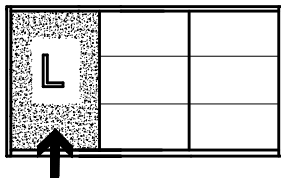
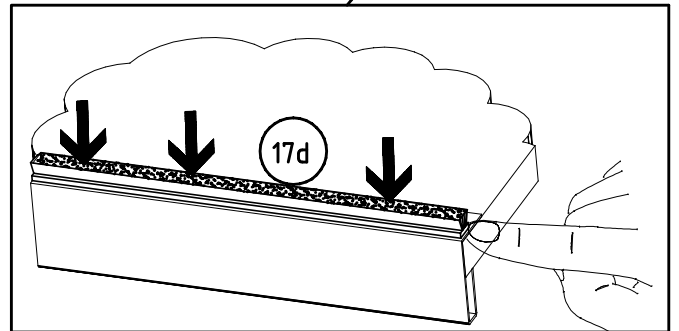
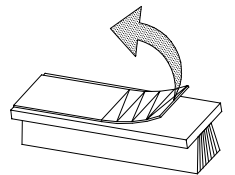
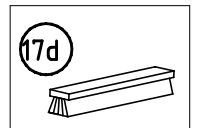
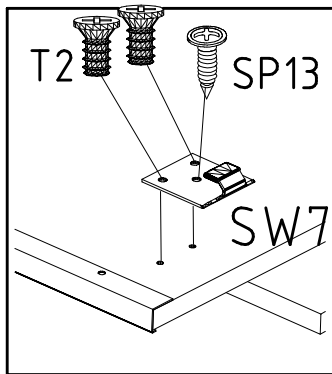
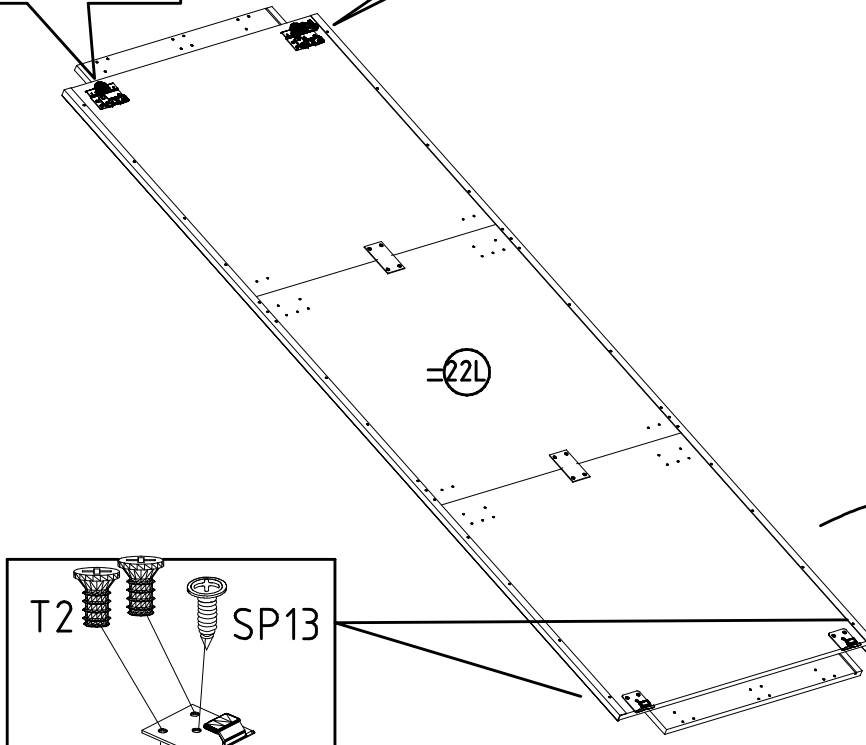
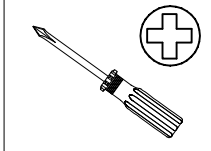

7

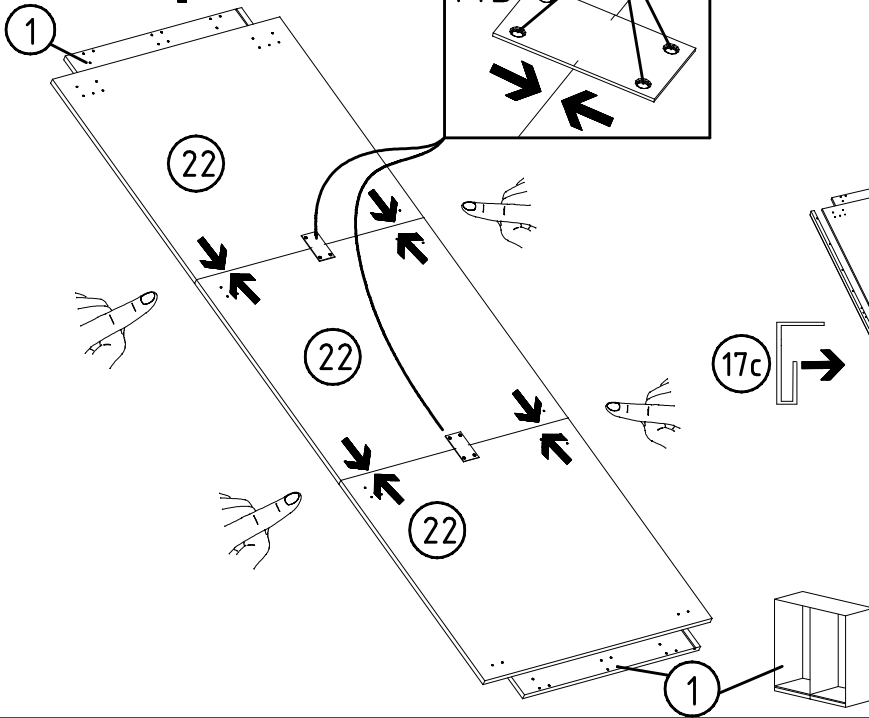
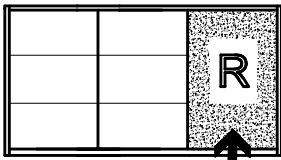

H5 114 183	4 X 13mm 121 122	SP13 	
---------------	---------------------	----------	--

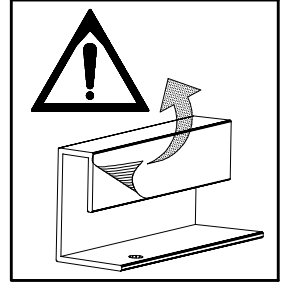

1x 17c	1x 17b

8

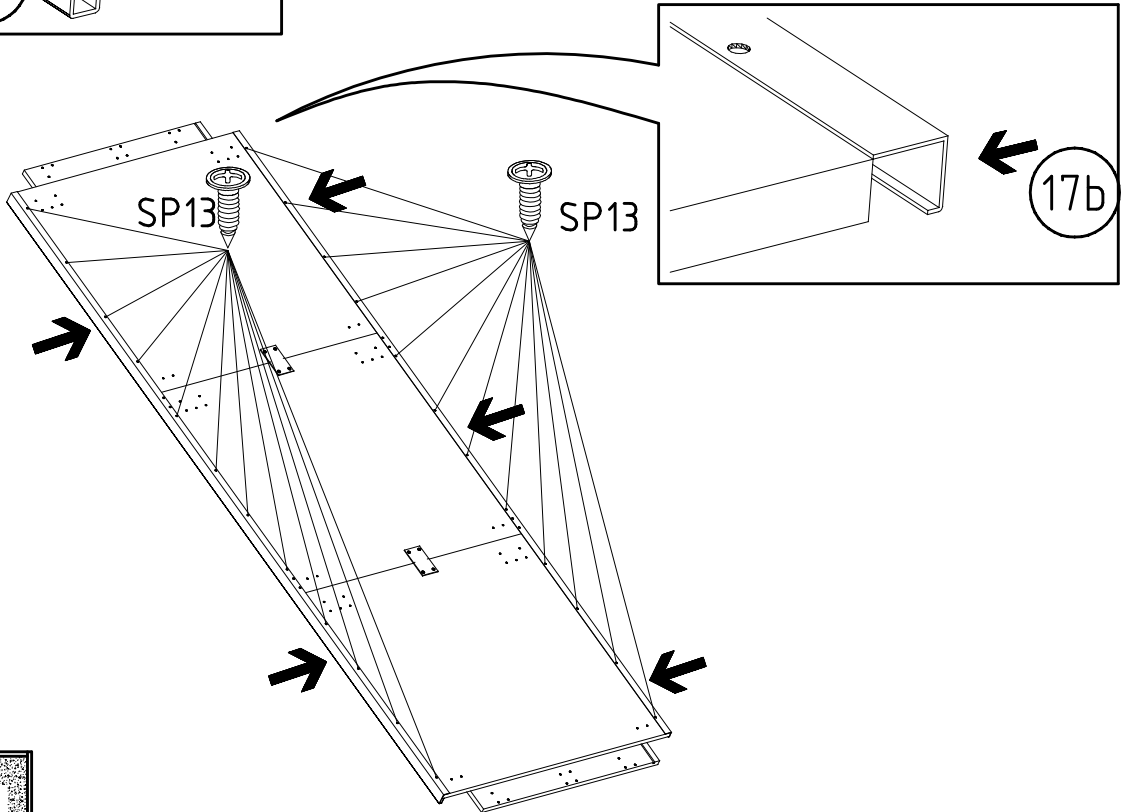
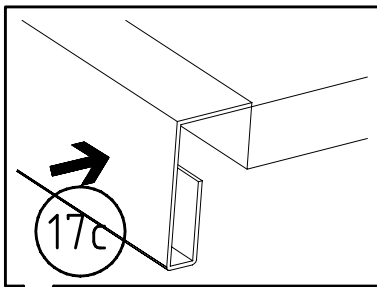

4 X 13mm 121 122	SP13

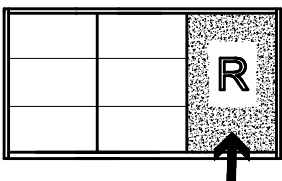

9

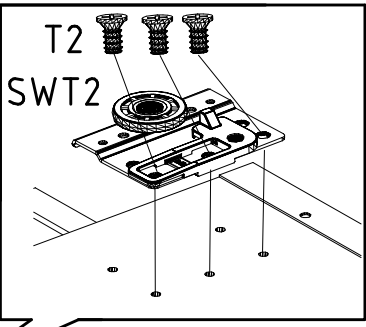
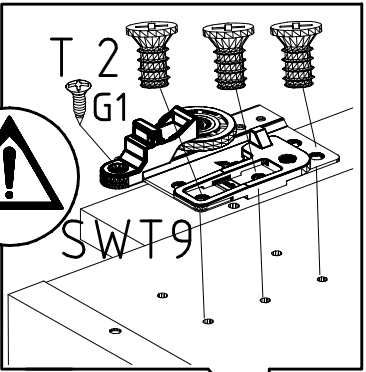

SWT2	SWT8
6,3 x 10,5 mm T2	SWH 7
111 030	
3,5 x 15 mm G1	SP13
	4 X 13mm
121 370	
	121 122

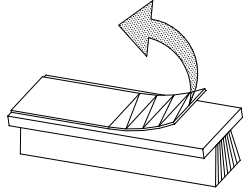
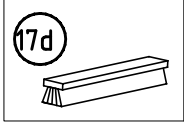

=22R

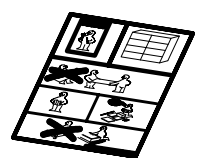
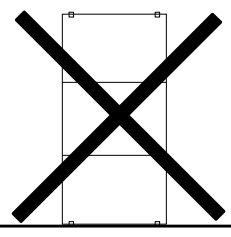
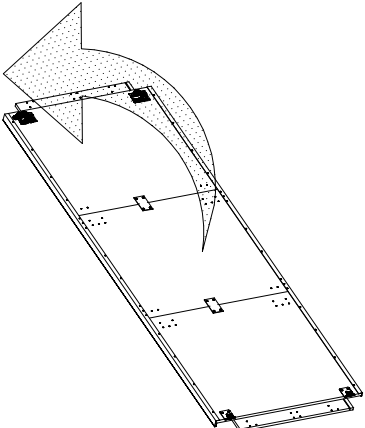
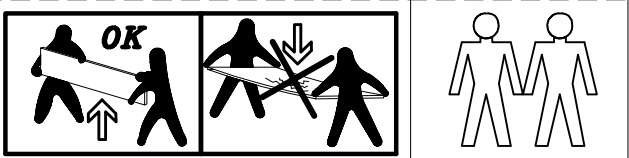
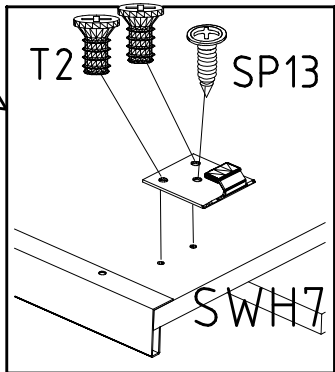
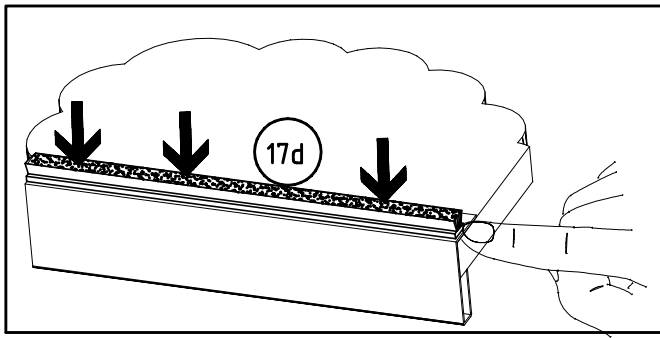
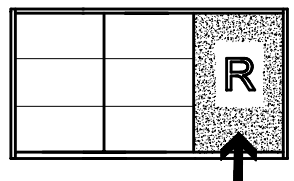

10

3,5 x 15 mm

G1



121 370

S0

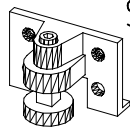

111 300

A1



111 149

12

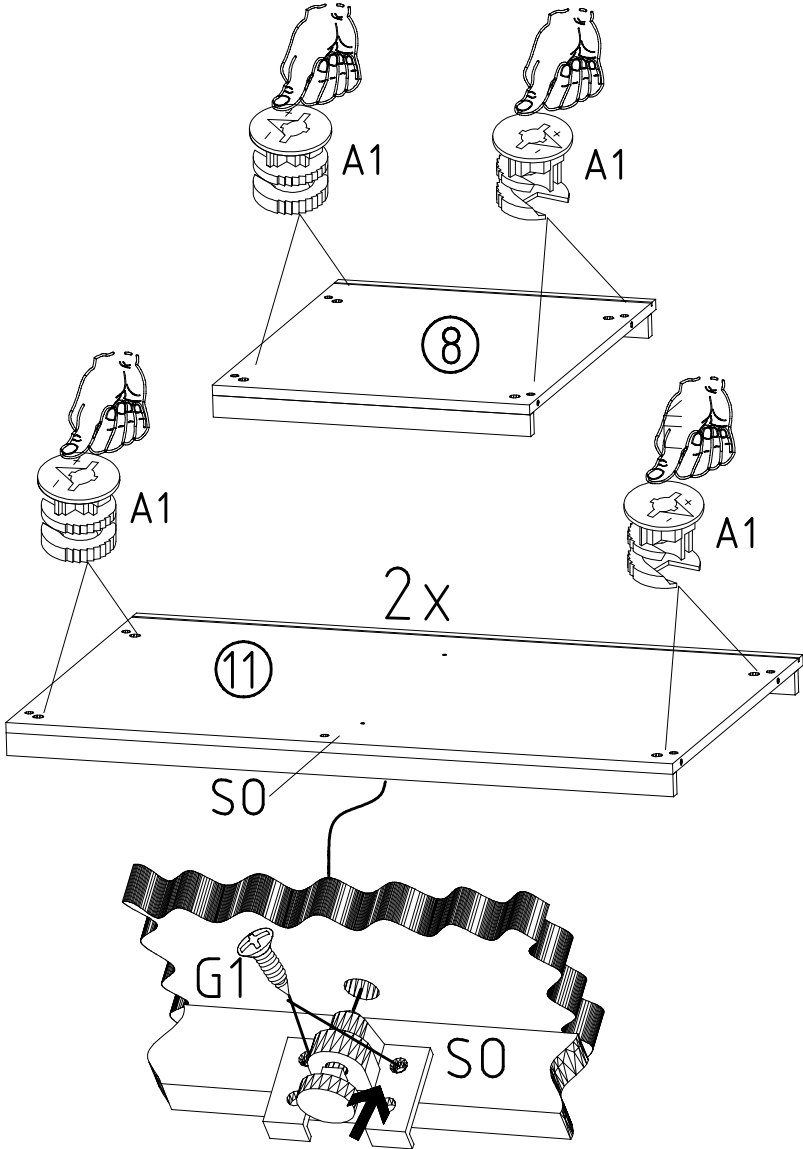

11

A1

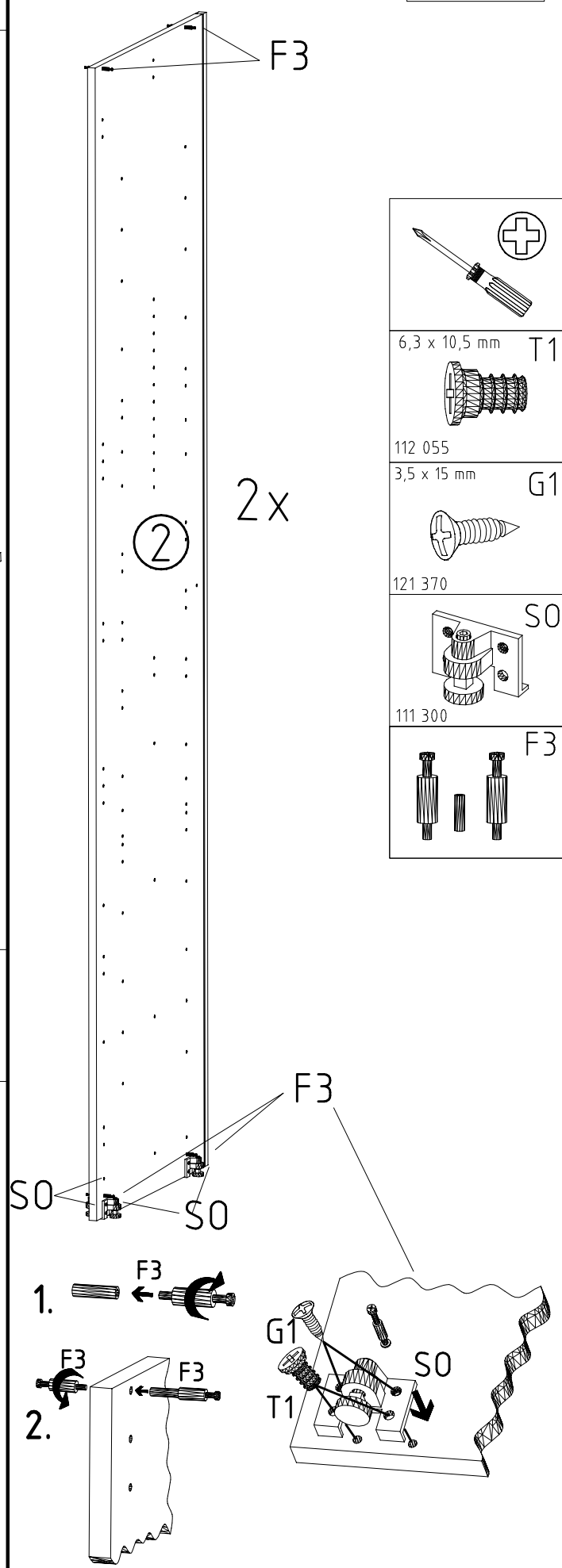
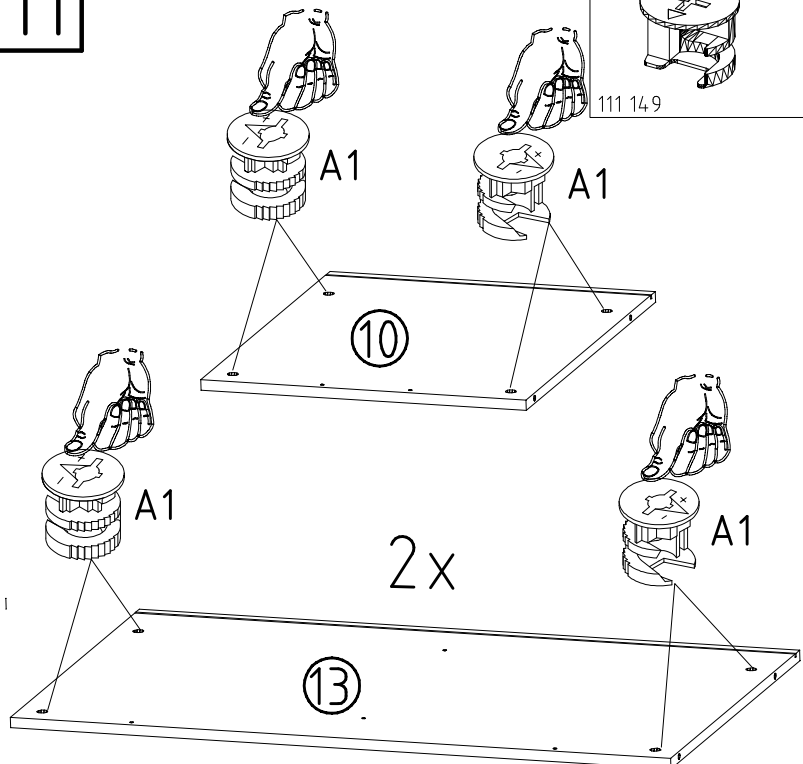

Parts list for step 12:

- Screwdriver (cross-head)
- Screw T1: 6,3 x 10,5 mm
- Screw G1: 3,5 x 15 mm
- Bracket S0: 111 300
- Pins F3

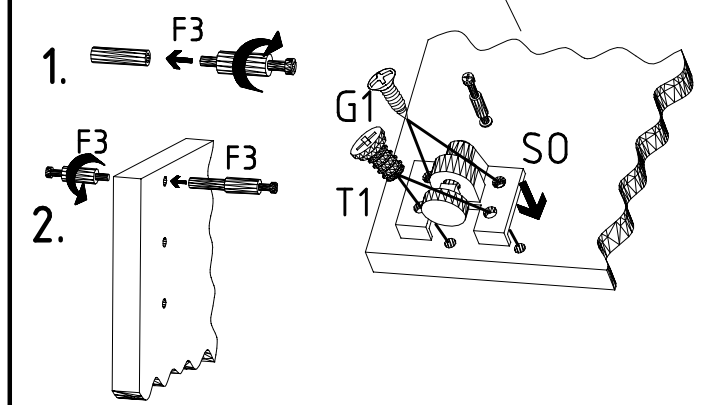

980717

24.03.23 / -

03 23 | 10 / 19

13

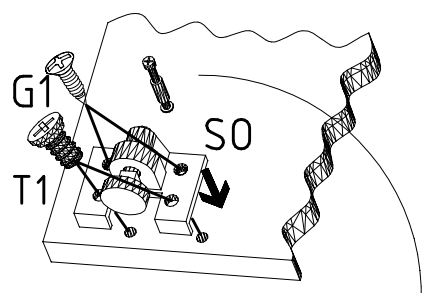
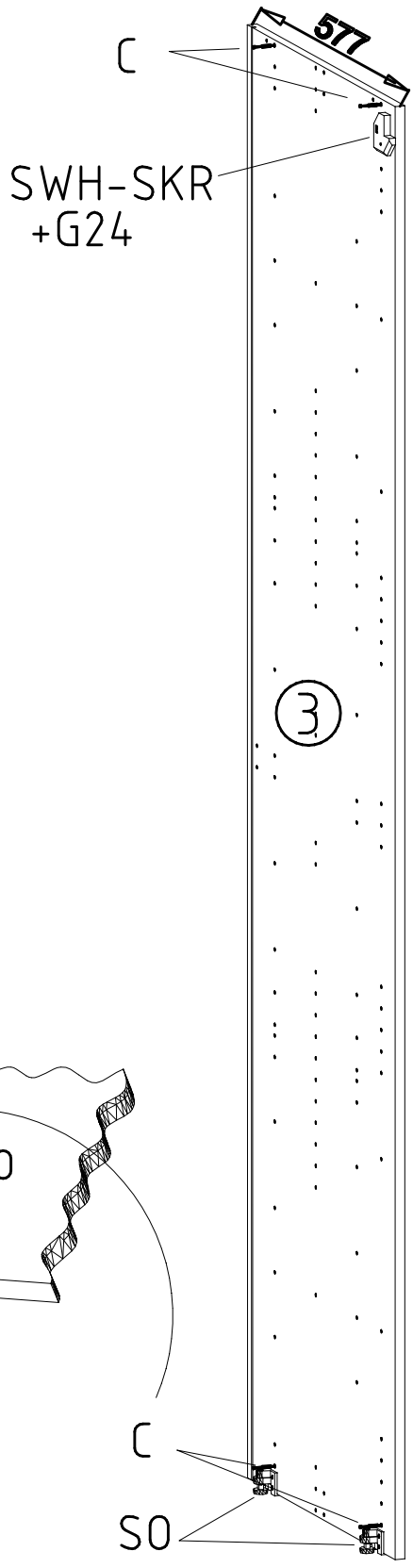
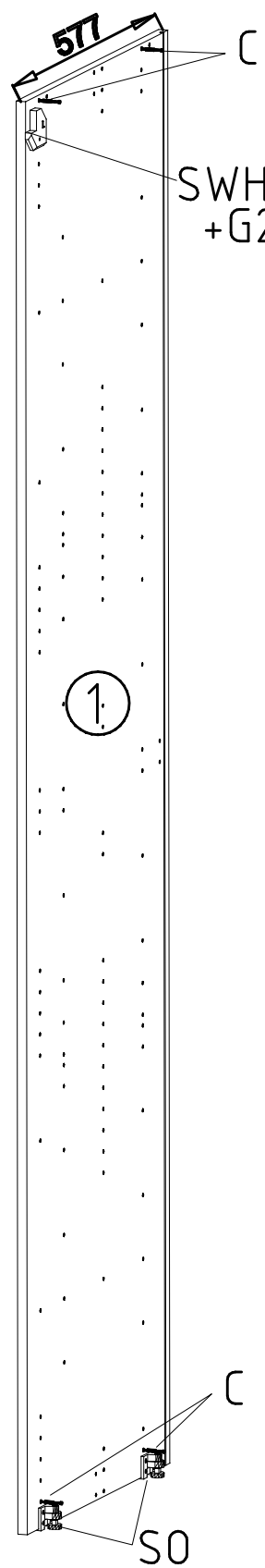
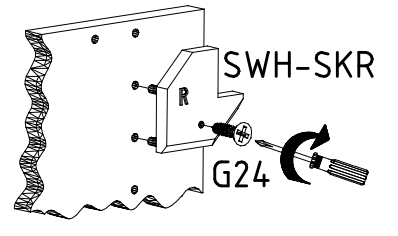
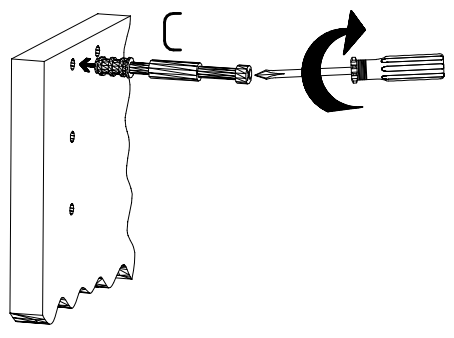
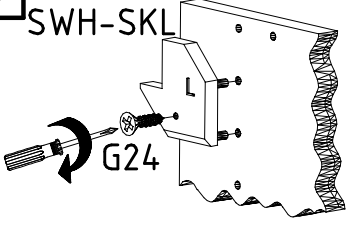

-
- SWH-SKL**
- SWH-SKR**
- 3,5 x 22 mm **G24**
- 121 004
6,3 x 10,5 mm **T1**
- 112 055
3,5 x 15 mm **G1**
- 121 370 **C**
- 111 103 **S0**
- 111 300

14

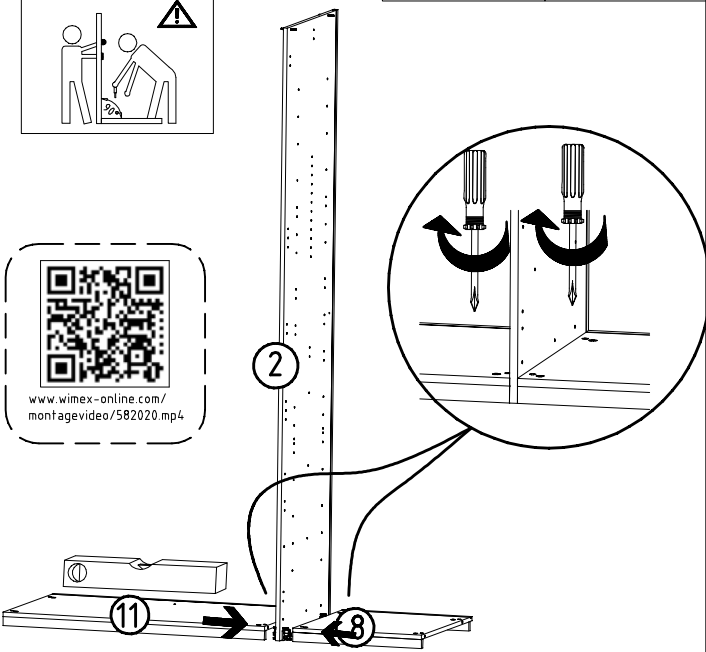
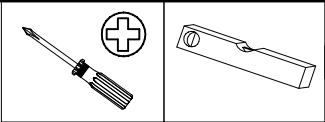

15

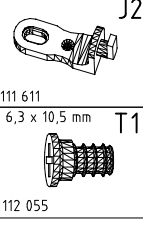
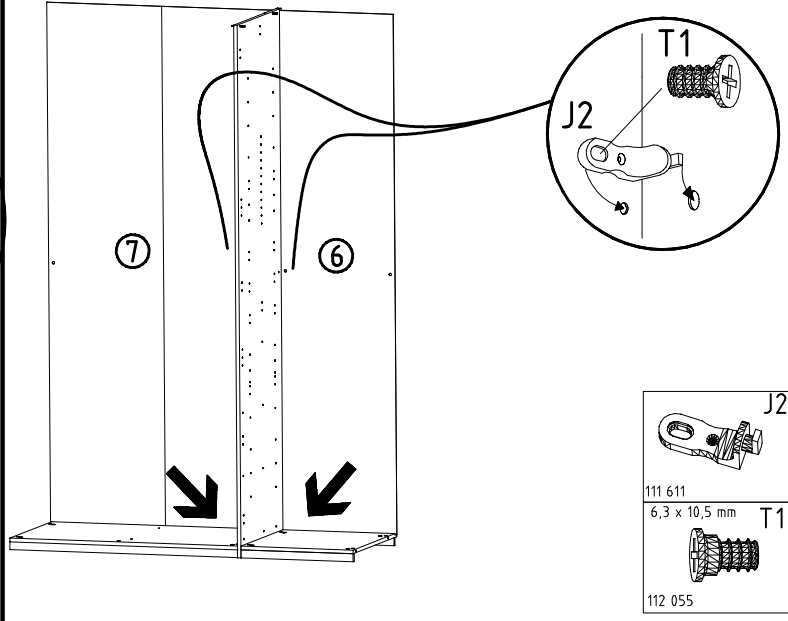
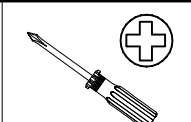

16

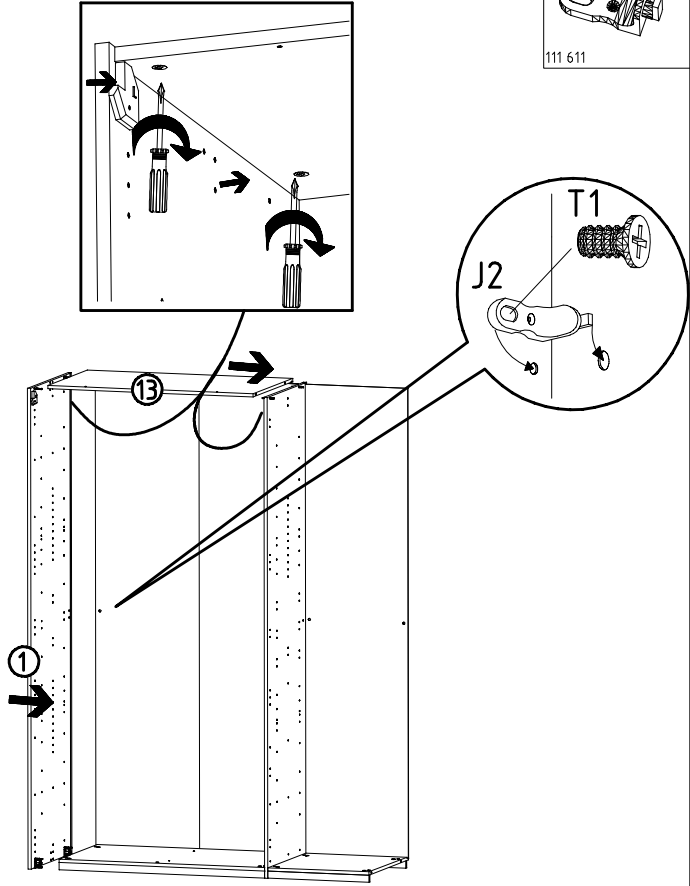
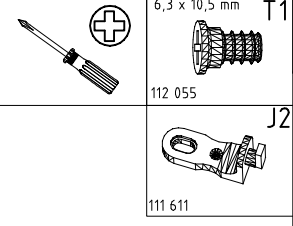

17

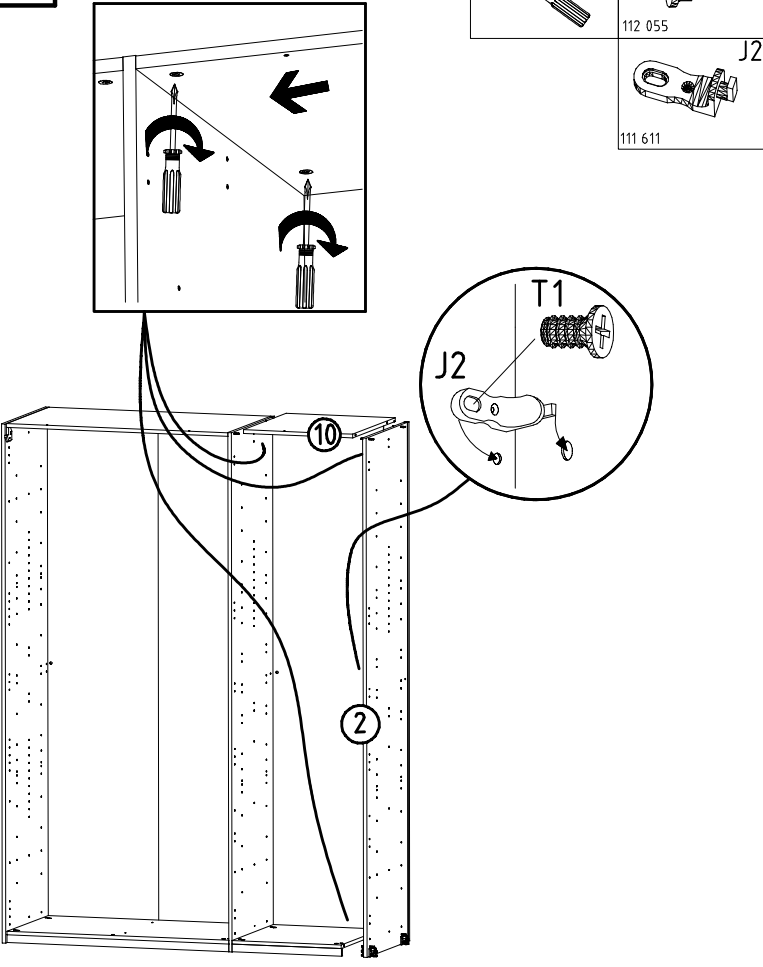
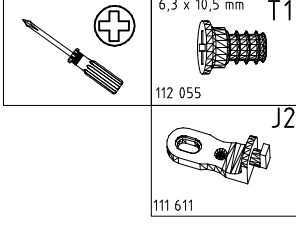

18

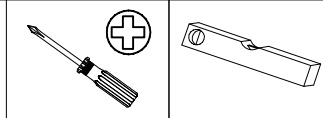

19

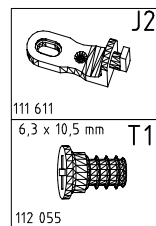
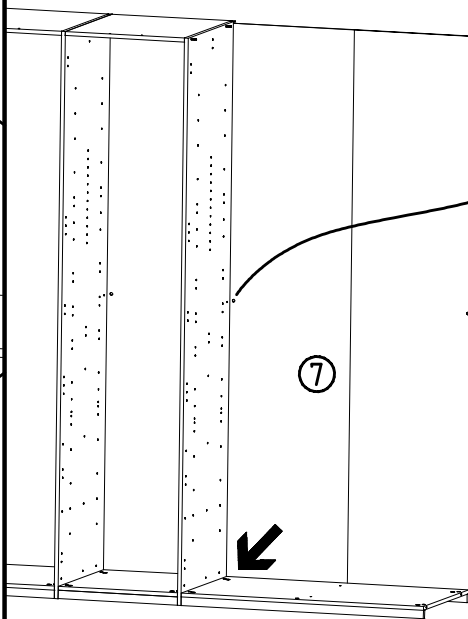
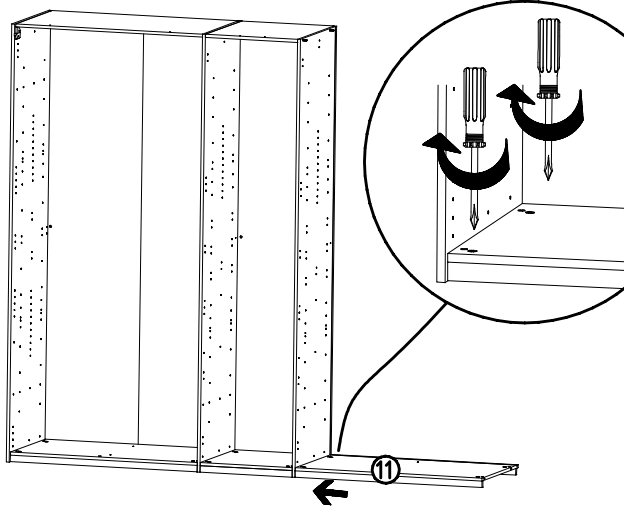

20

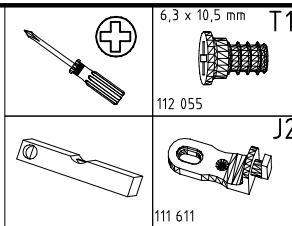
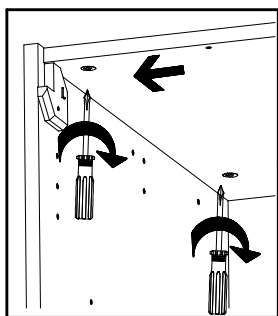

21

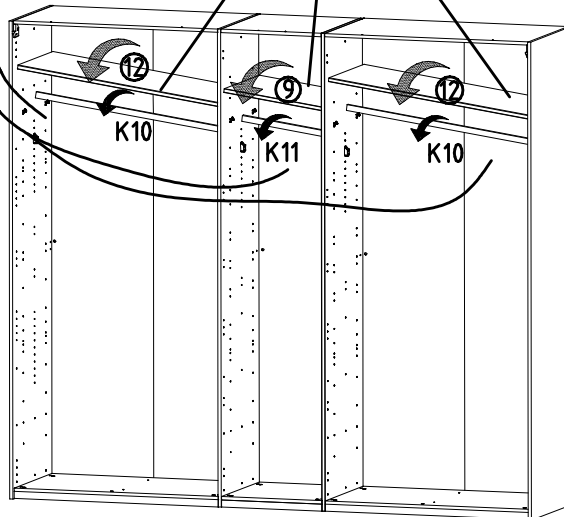
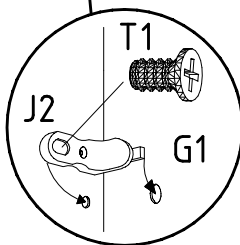
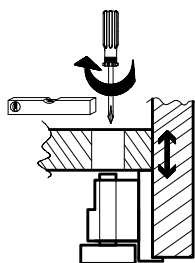
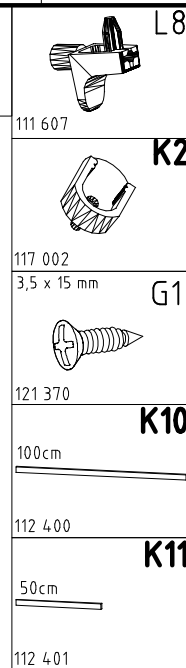
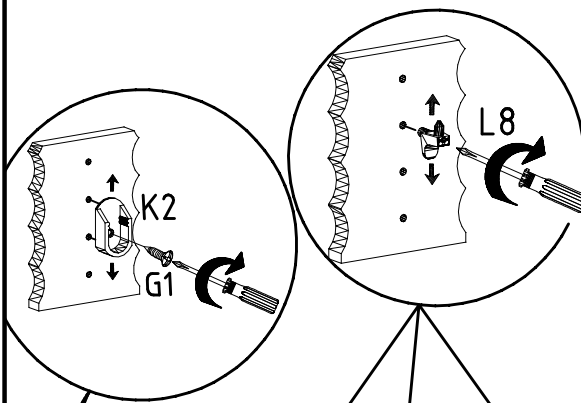
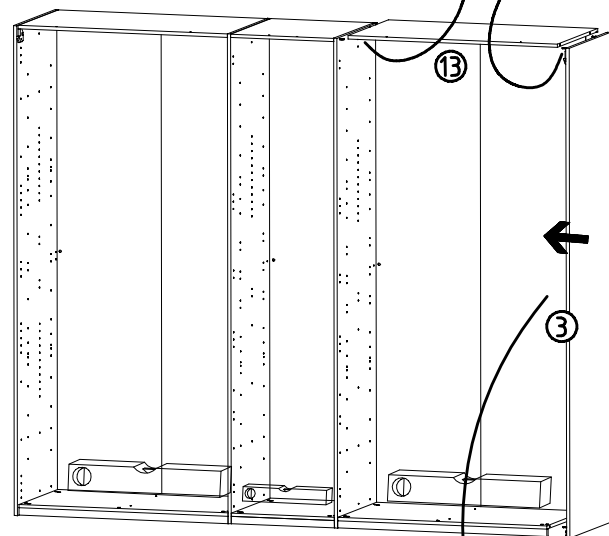
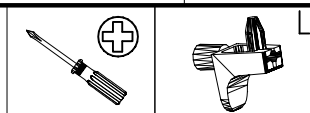

980717

24.03.23 / -

03 23

13/19

22

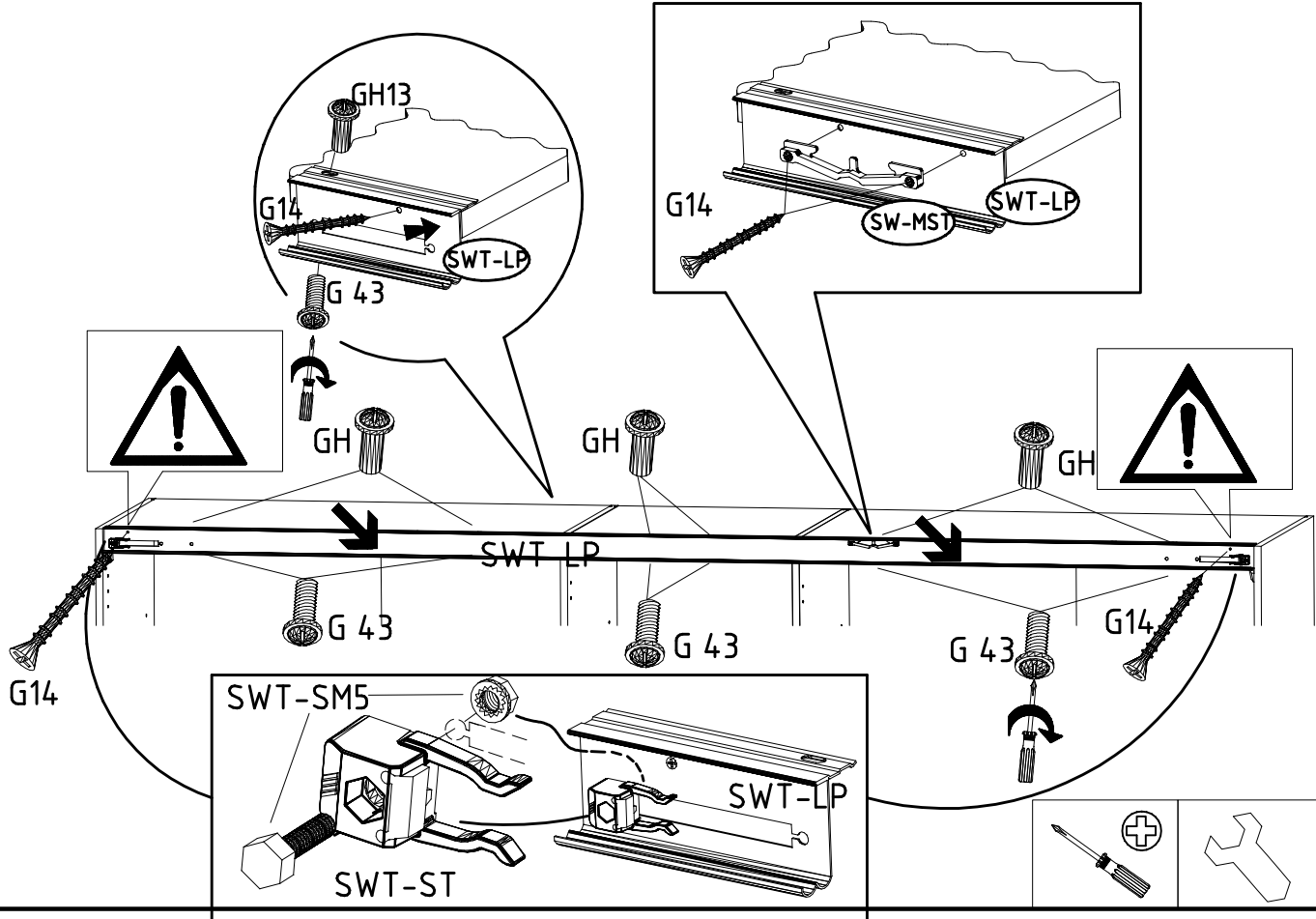
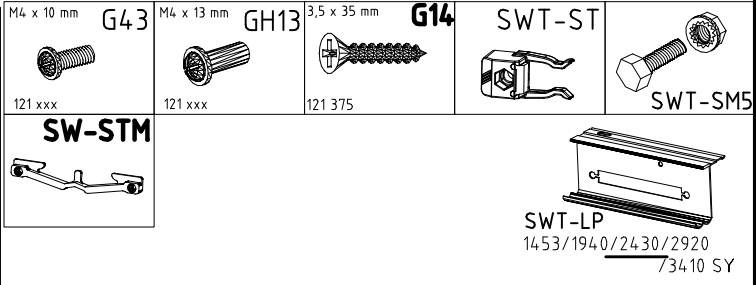
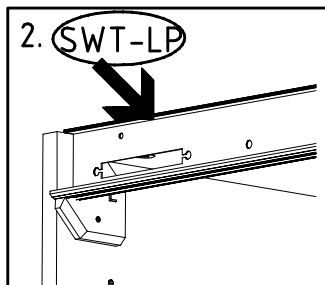
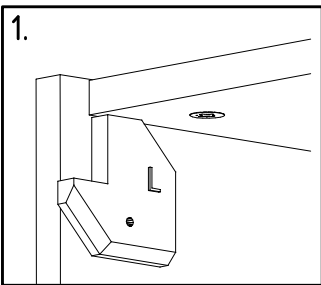

23

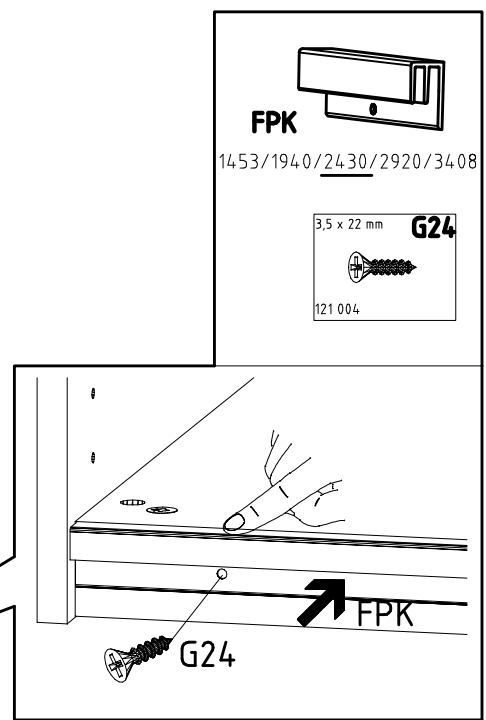
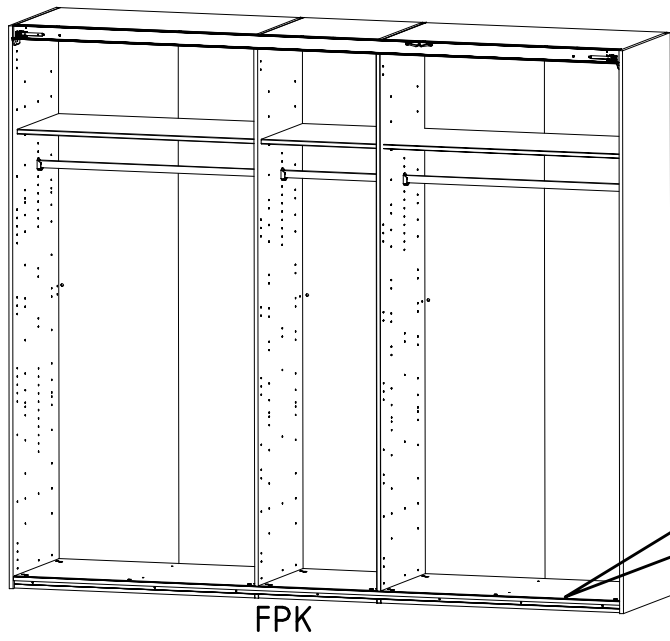

24

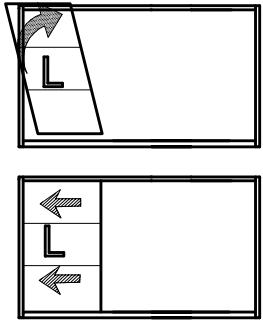

25

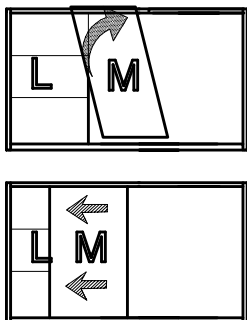

26

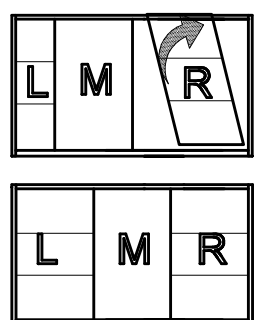

24 + 26

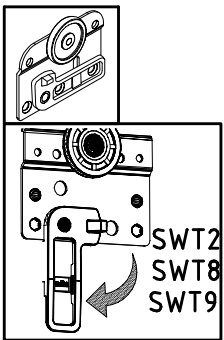
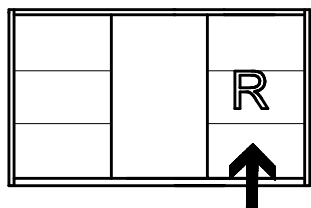
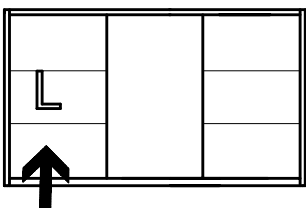

I.

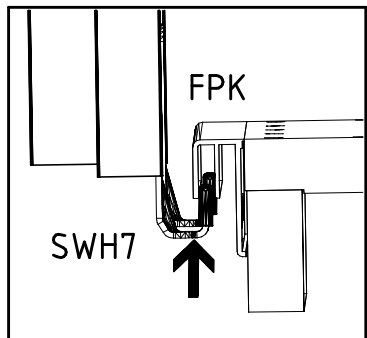

II.

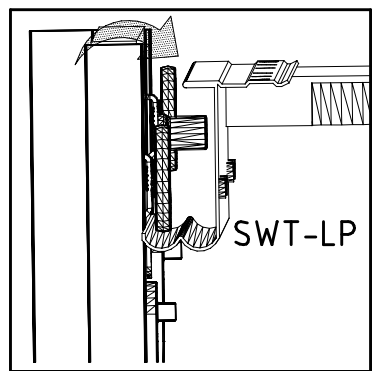

III.

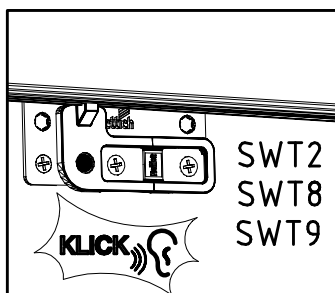
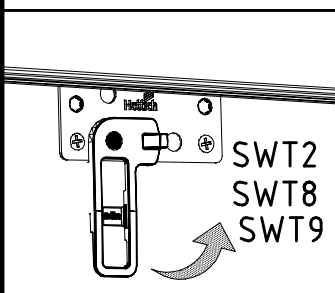

25

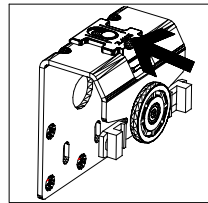
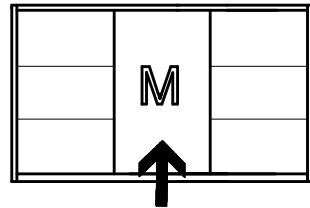

I.

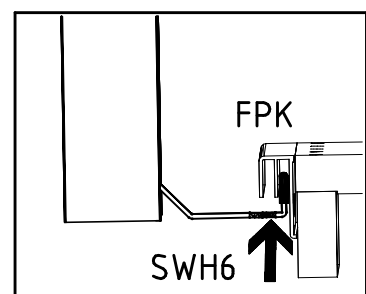

II.

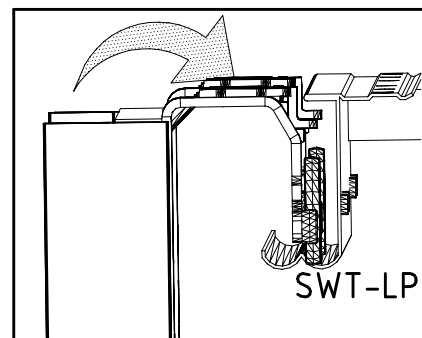

III.

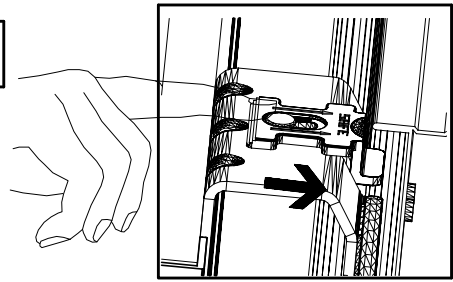

27

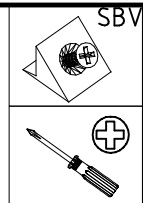
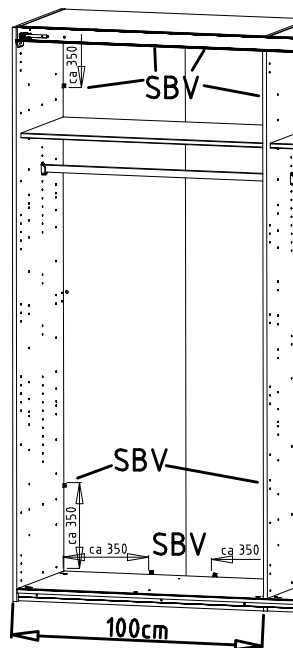
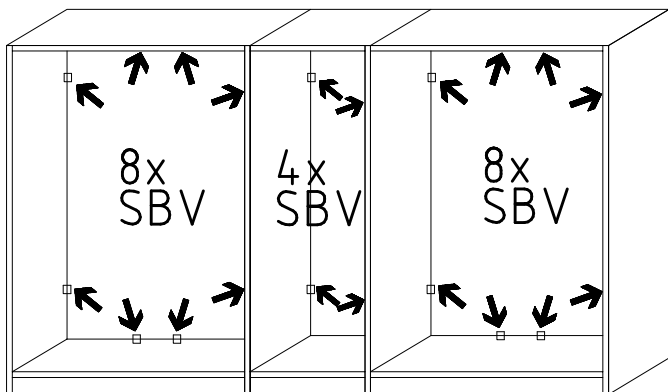
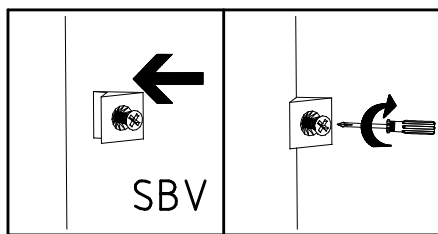

28

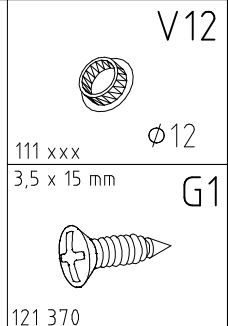
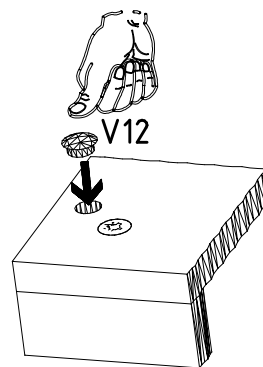
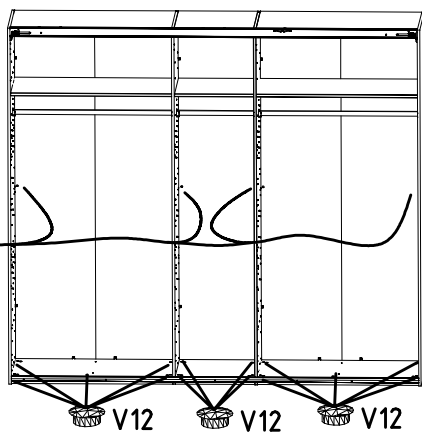
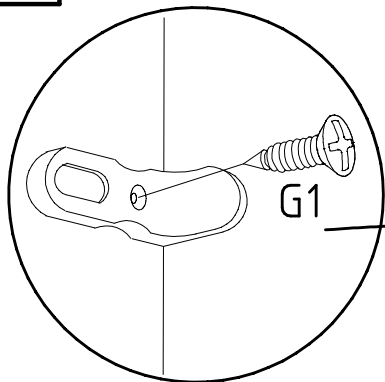

29

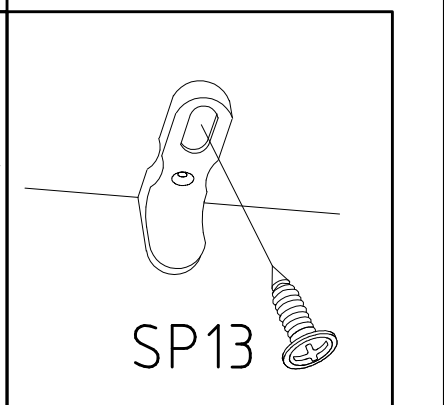
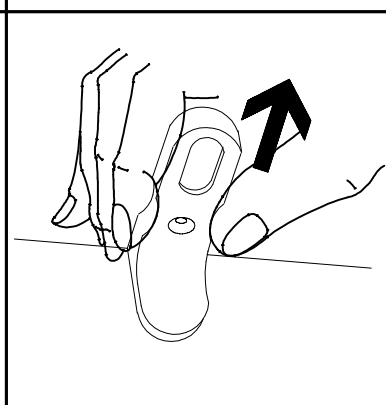
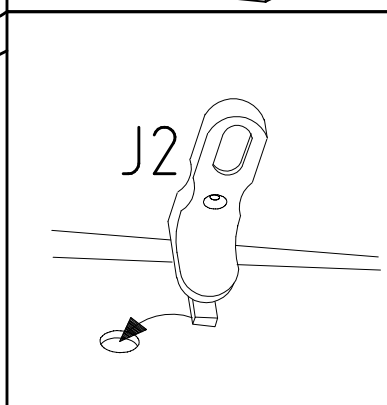
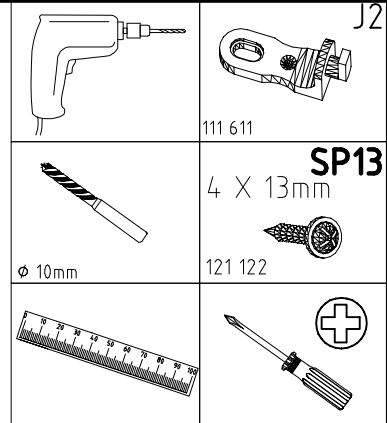
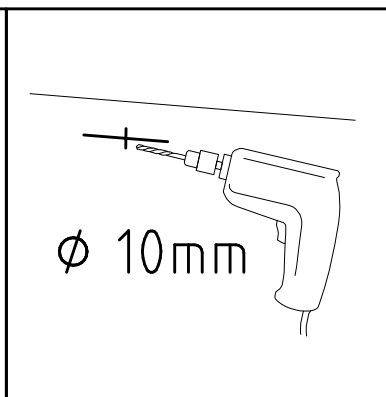
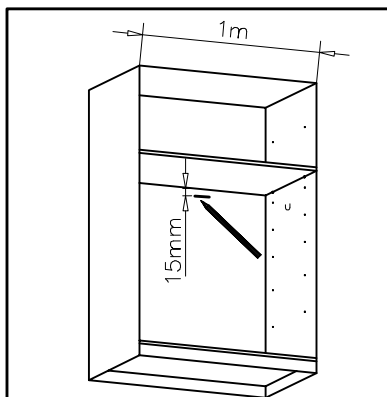
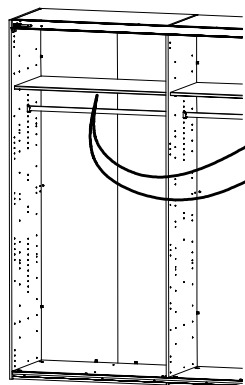

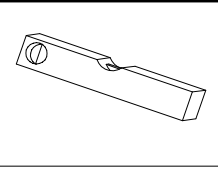
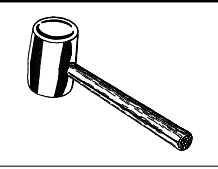
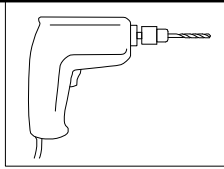

SP15
4 X 15mm
121 120

o10
111 052

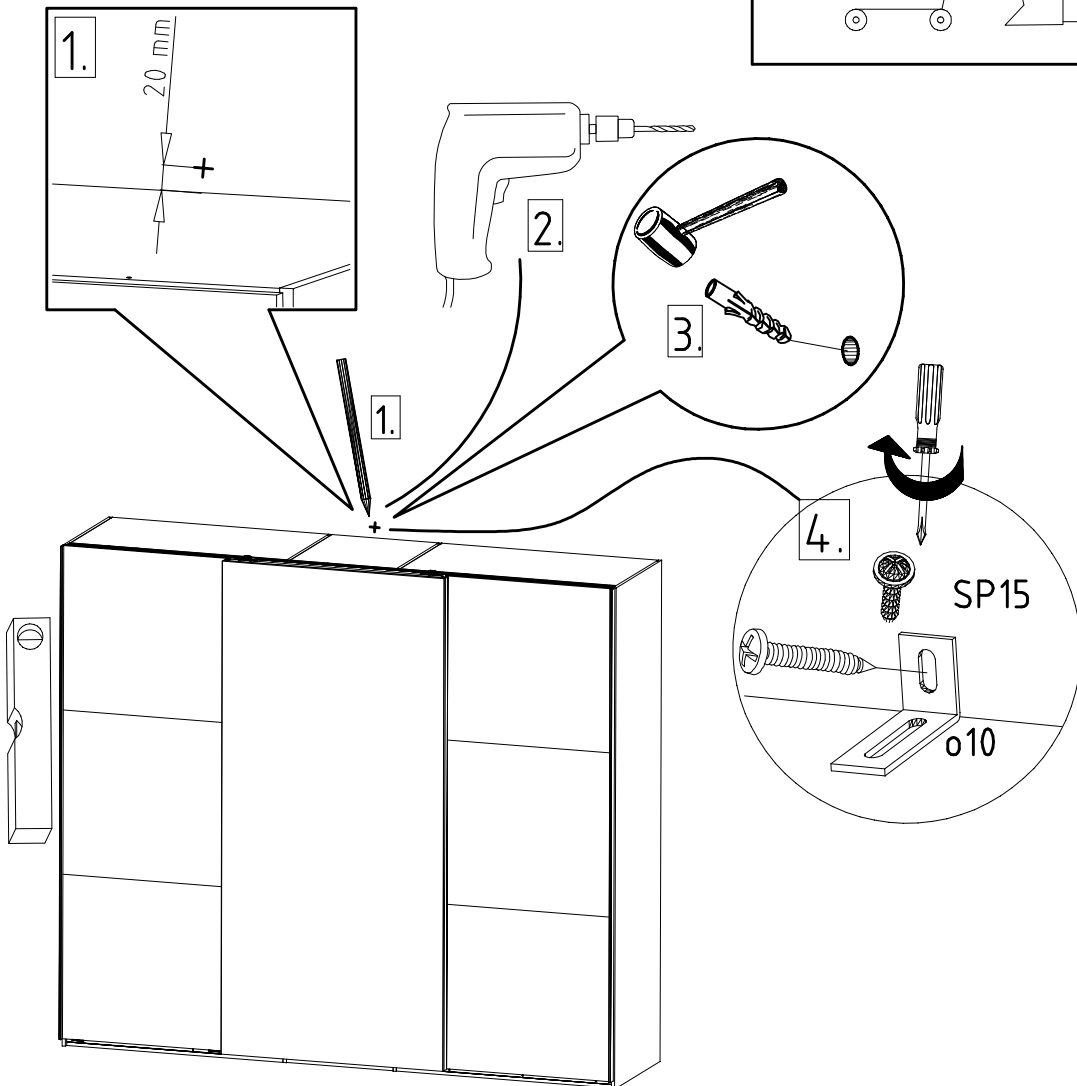
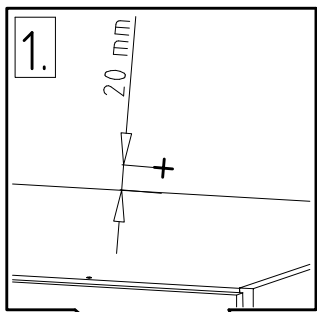
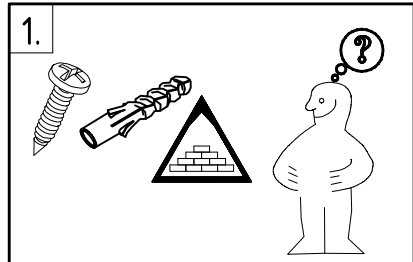

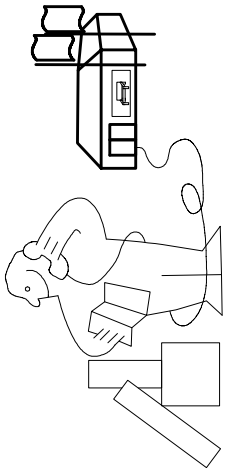
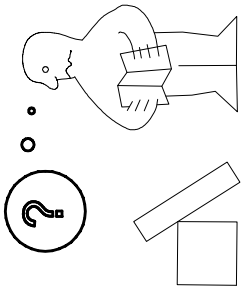

Illustration of a person cutting a box with a utility knife, with a 5 Euro note nearby.

Modell/Modèle

Illustration of a person cutting a box with a utility knife.

Illustration of a person cutting a box with a utility knife.

Illustration of a person cutting a box with a utility knife.

Illustration of a person cutting a box with a utility knife.

Illustration of a person cutting a box with a utility knife.

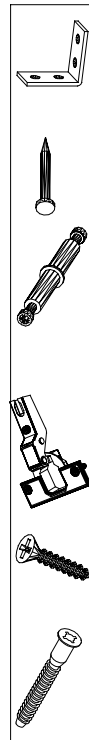

<121 370>	< G 1 >	<4x>

Änderungen die dem technischen Fortschritt geschuldet sind, behalten wir uns vor!
 Bei nicht vorschriftsmäßiger und/ oder nicht fachmännischer Montage wird bei Personen- und/ oder Sachschäden keinerlei Haftung übernommen.
 WIMEX Wohnbedarf Import Export Handels GmbH & CoKG / Postfach 1407 / 49112 Georgsmarienhütte / Germany
 Tel.:(+49) 05401 8598 0 Fax.:(+49) 05401 8598 33 Mail: service_H@wimex-online.com

23203	30110XY
Kunde / Customer / Client: MAX MUSTERMANN	
Kommission / your order reference / votre reference: 3377 MINDEN	
Dekor / Decor: F99	
Modell / Model: SAMPLE	
F99842 SCHWEDLUEBENSCHRANK 250 CM H 216CM PLANKENEICHE NB + RAU STEEL PLANKENEICHE NACHBILDUNG	
414760	
SOCKEL	
Paket / Package / Paquet: 1 von 8	Colli Kommission: 10
HSP-SWT BOD 50 TEXT/TEX SOCKEL 32 FRESH TV / TV SO-BOD TEXT RASTEX / ZWBOD D18MM 1X KLSTA 104	
Montage - Anleitung: KS-64	Laenge: 520,0 Breite: 568,0
SOCKEL32 KLEB	



104
 OBEREN 5 30/19
 HAUT
 23.08.19
 OBEREN 11
 ABOVE
 OBEREN



WIMEX Wohnbedarf
 Import Export Handelsges mbH & Co. KG
 Werner-von-Siemens-Str. 35
 D-49124 Georgsmarienhütte - Germany

SAMPLE **23.08.19**
 Modellname Produktionsdatum
 Model Date of manufacture

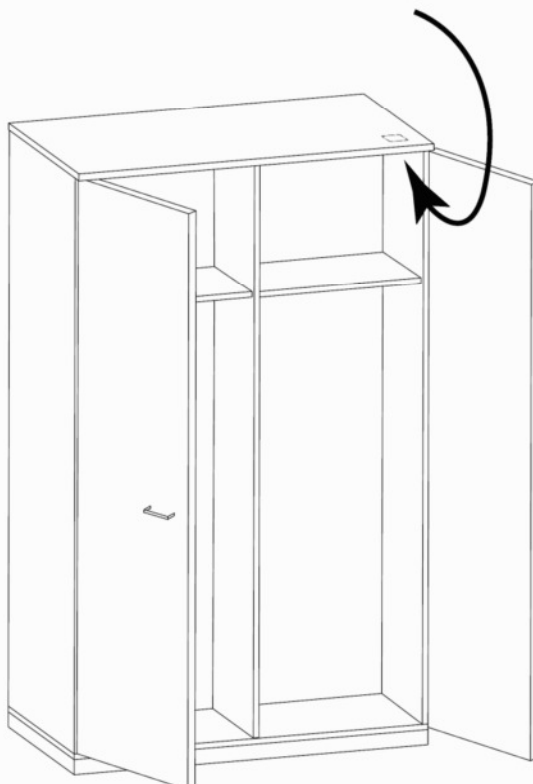
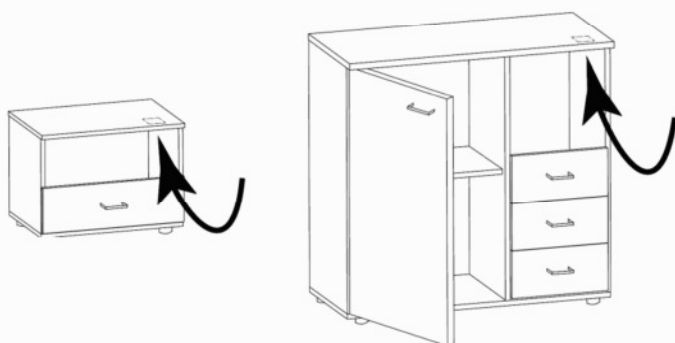
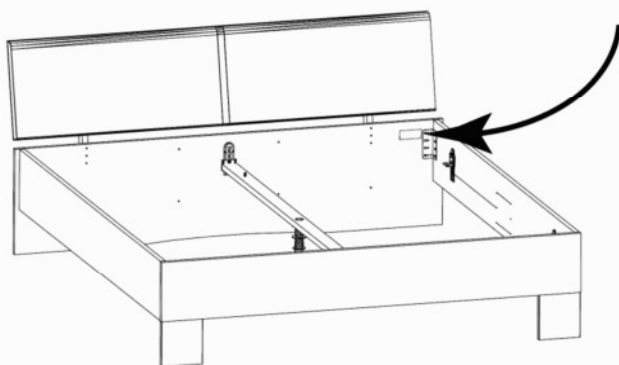

980832

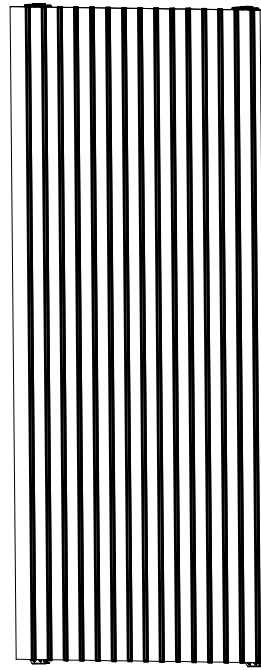
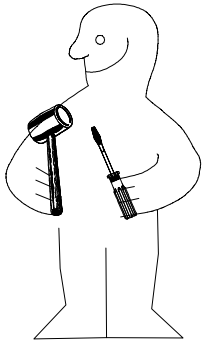

Frontenmontage

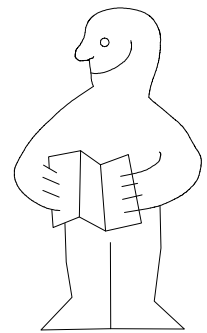
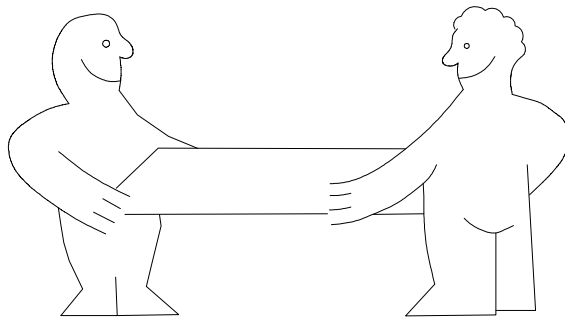
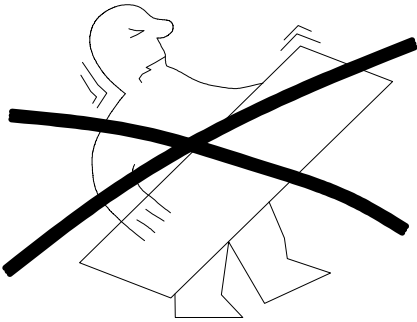

1-2-3-4... ○ ○

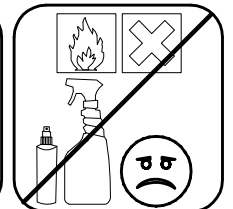
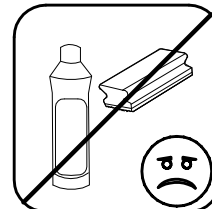
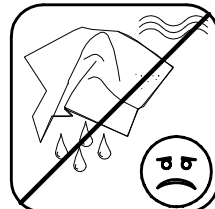
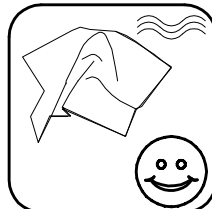
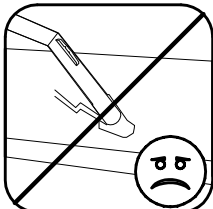
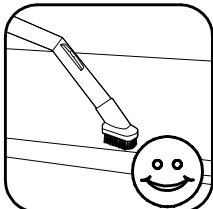
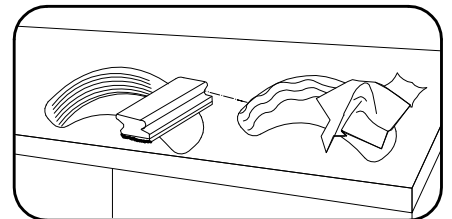
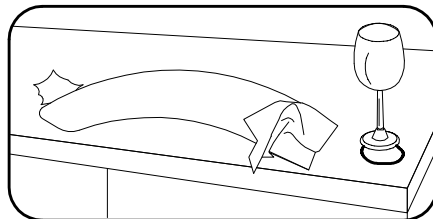
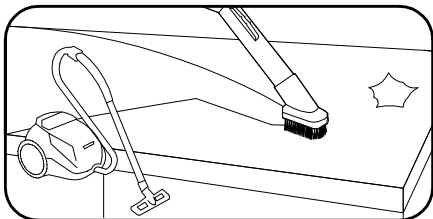
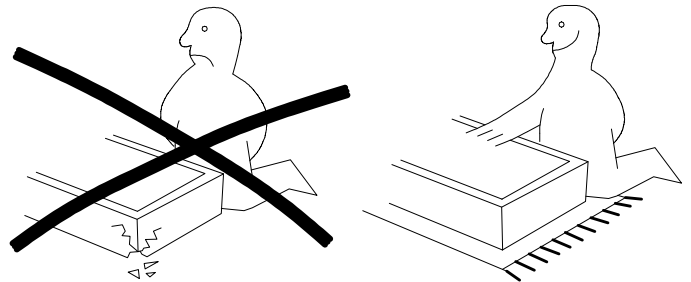
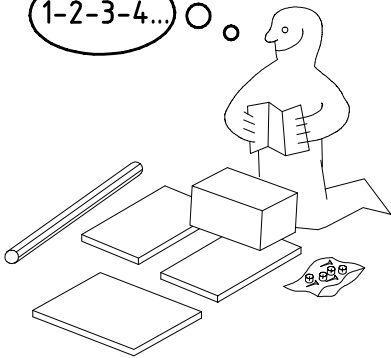

980832

08.02.23 / 01.07.23

07 23

1/4

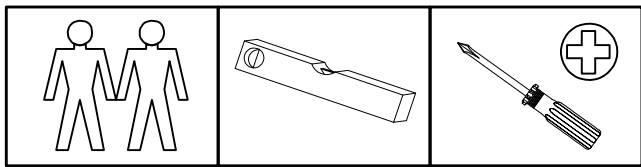

4 X 13mm SP13 121 122	32x	SWH 6	2x
SW-AK	2x	SWT 1	2x
		6,3 x 10,5 mm T2	14x
		111 030	

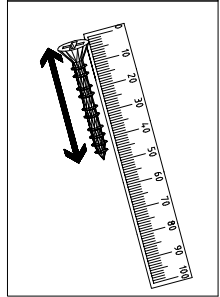
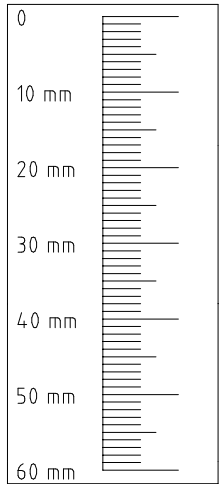

2x 17c



2x 17e

17e

17c

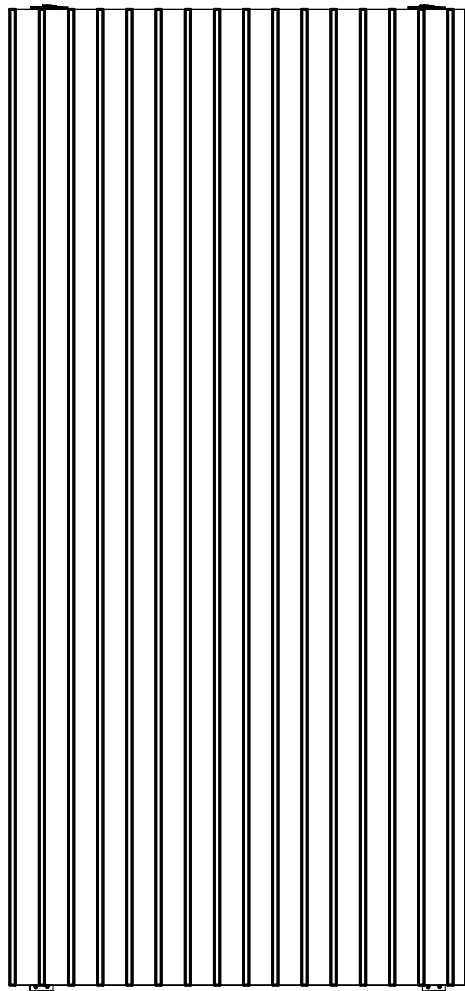
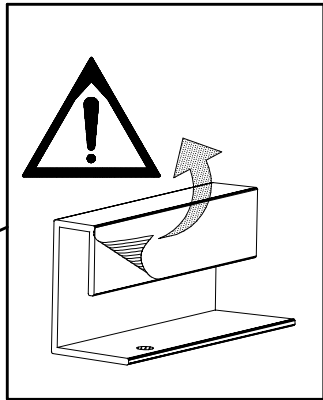

2124 / 2316 x 990 x 15

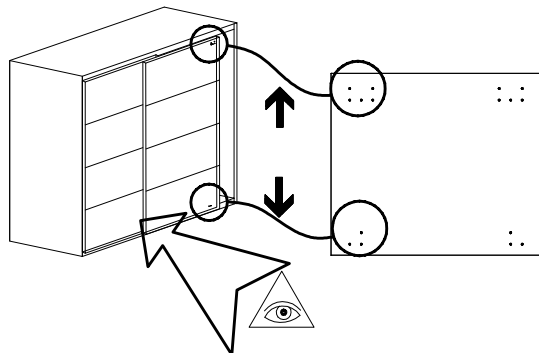

1

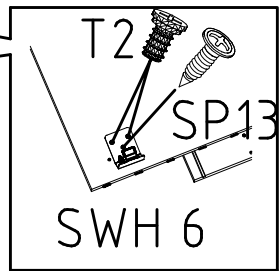
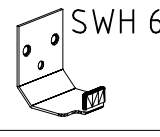
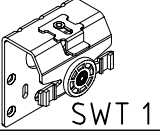
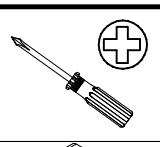
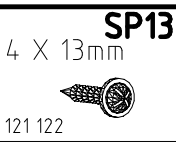
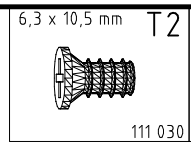
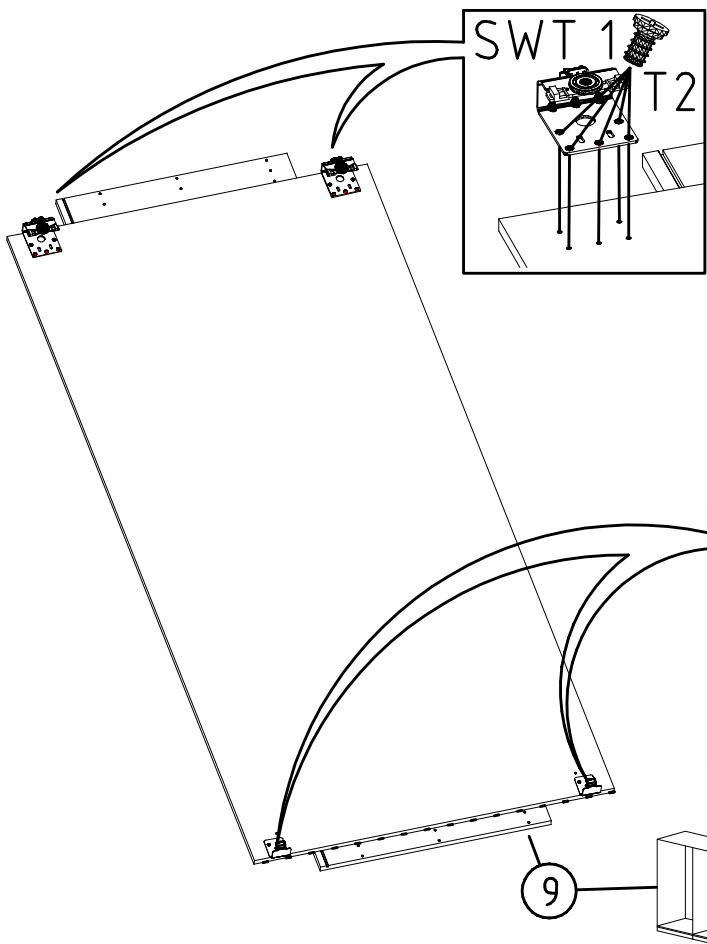

2

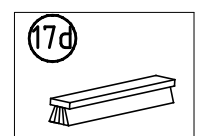
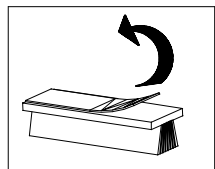
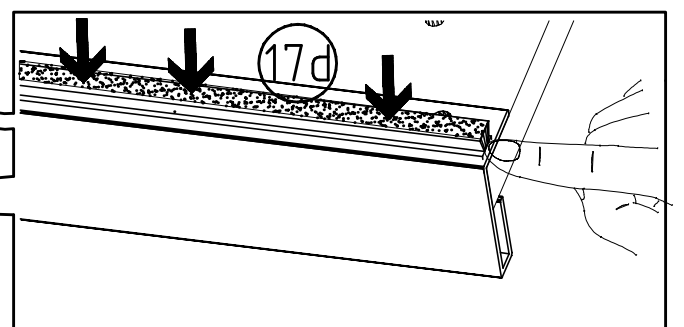
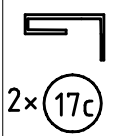
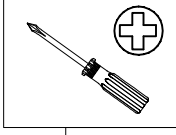
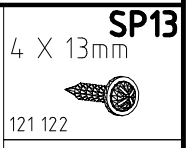
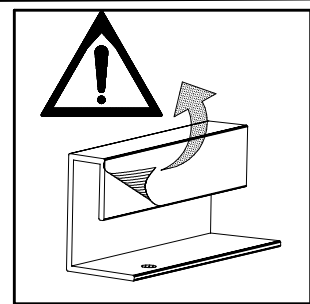
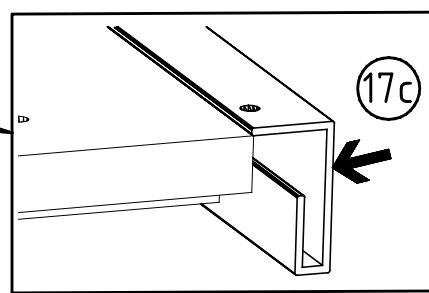
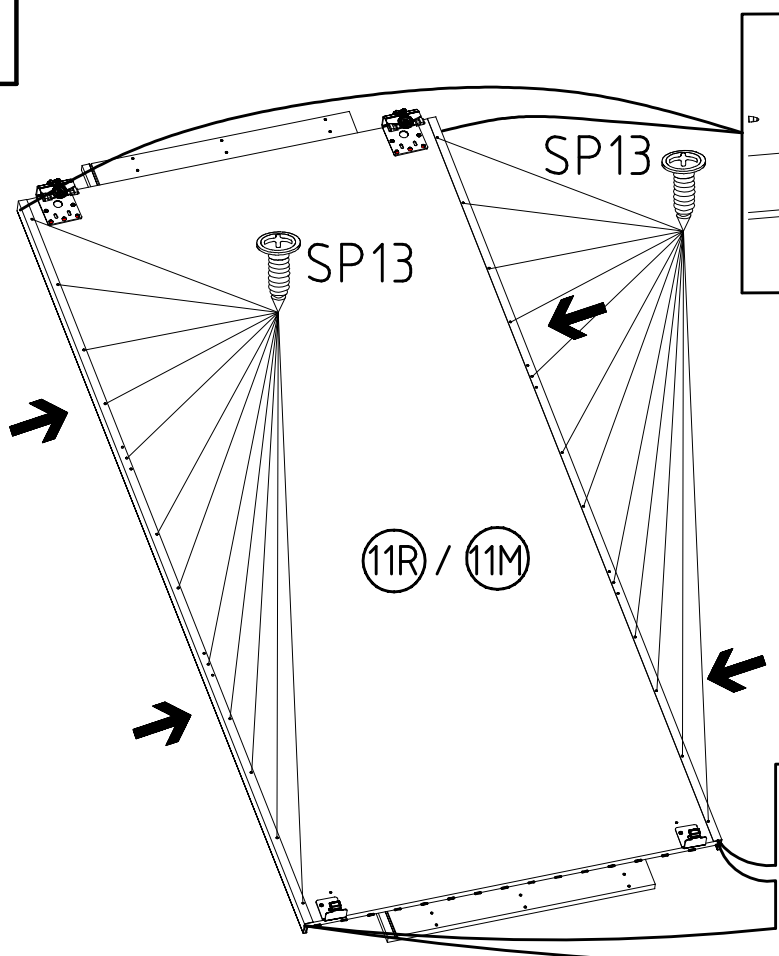

3

SW-AK

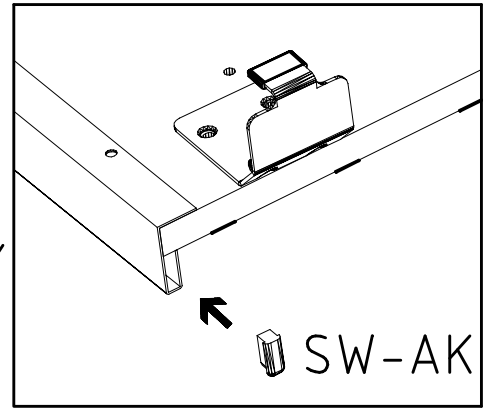
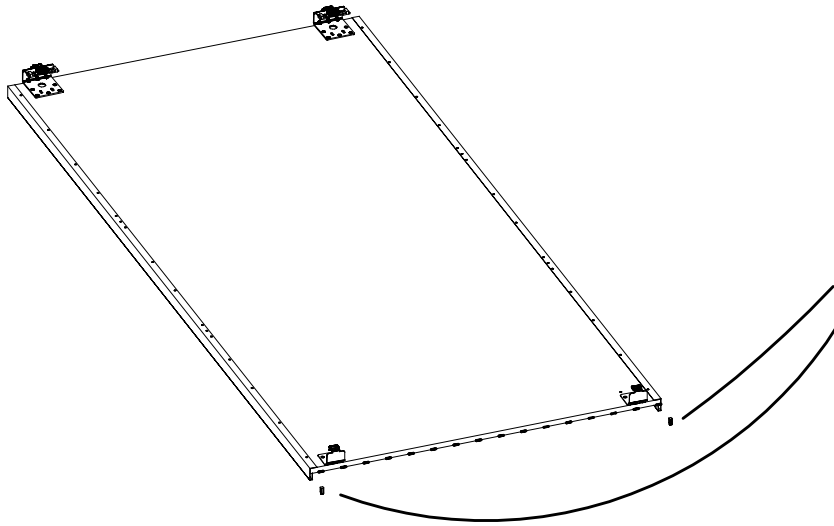

4

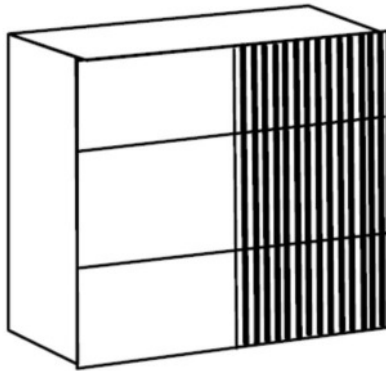

11R

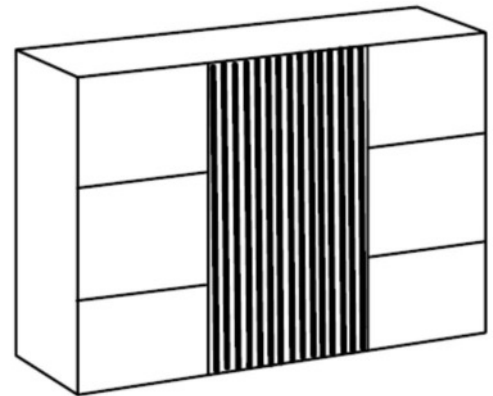

11M

5

