

# WH400 0800/0900/1000 (L/R)

**Achtung!** Gläser niemals ungeschützt auf den Boden stellen.  
Verletzung der Glaskante führt zu Glasbruch.

**Caution!** Never put glass walls on the floor without protection.  
Damaging the glass edges results in breaking of the glass.

**Attention!** Jamais placer des parois de douche en verre au sol sans protection. Des verres endommagés casseront.

**Mögliche Einsatzgebiete des Elements WH400:**  
(MAL = Montageanleitung)

Nische, WH400+WHAN1928



Fronteinstieg, WH400+WH001

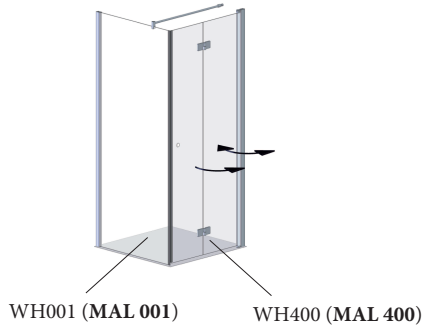

Eckeneinstieg, 2x WH400

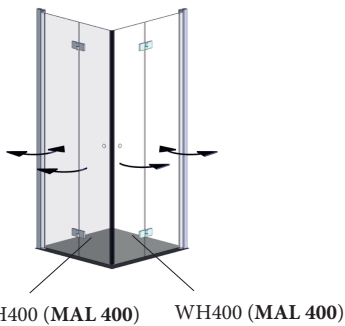

Die abgebildeten Formen der Profile und Griffe dienen der schematischen Darstellung und entsprechen nicht dem tatsächlichen Lieferumfang!

**CE**

Mitgeliefertes Montagematerial  
supplied assembly material  
matériaux pour assemblage

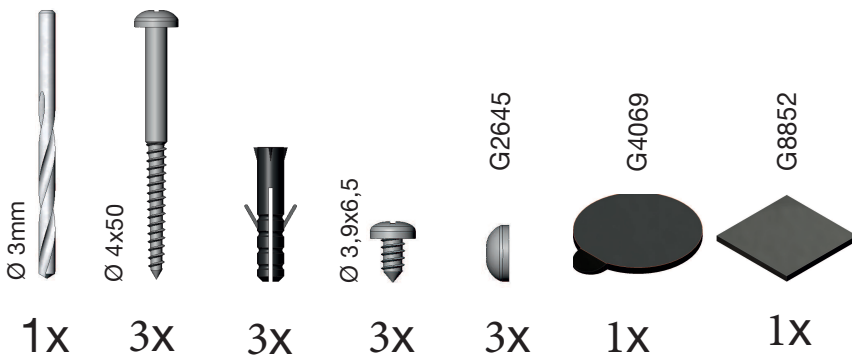

Zum Aufbau benötigen Sie  
for mounting you need  
pour l'installation il vous faut



5 Jahre  
Garantie

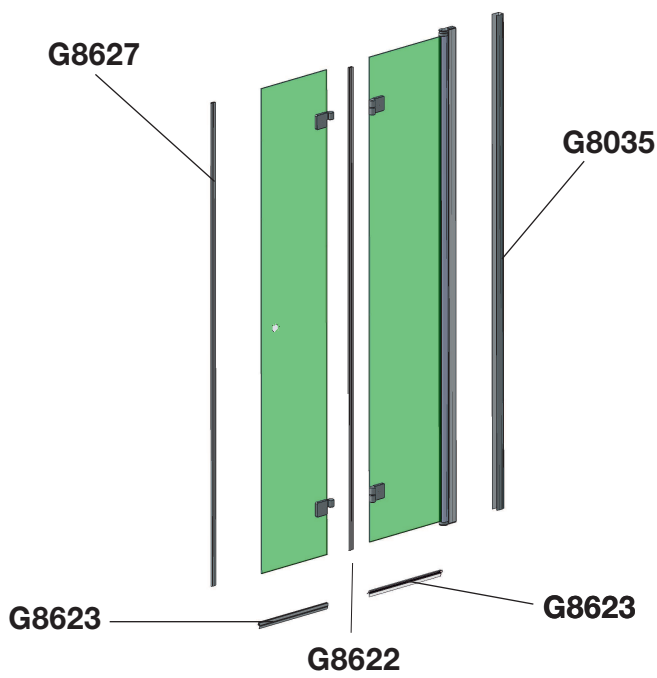

1

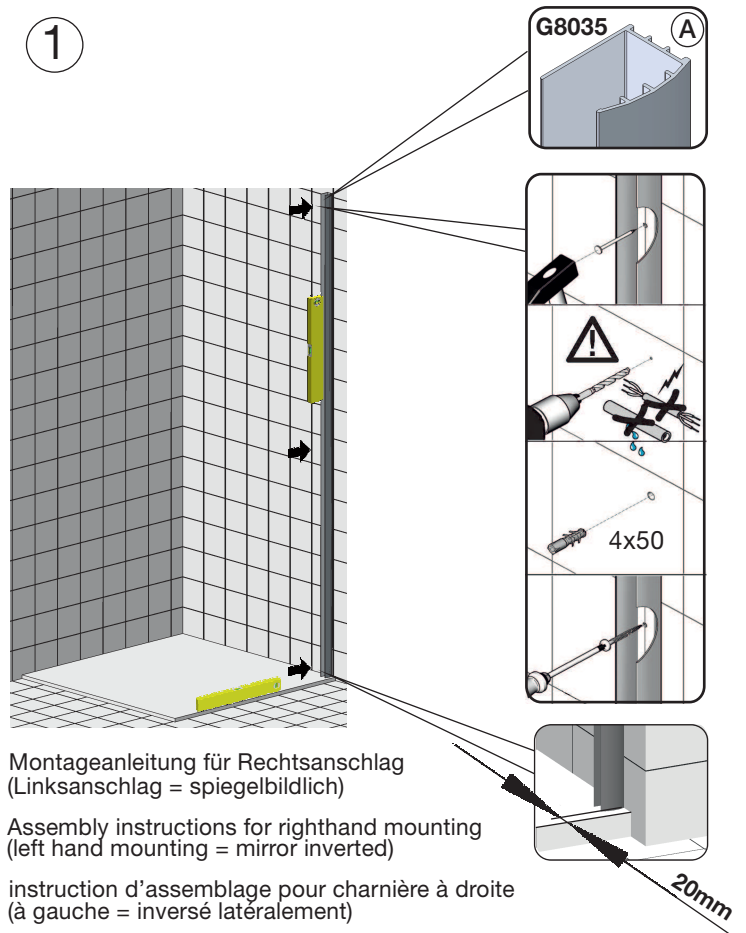

2

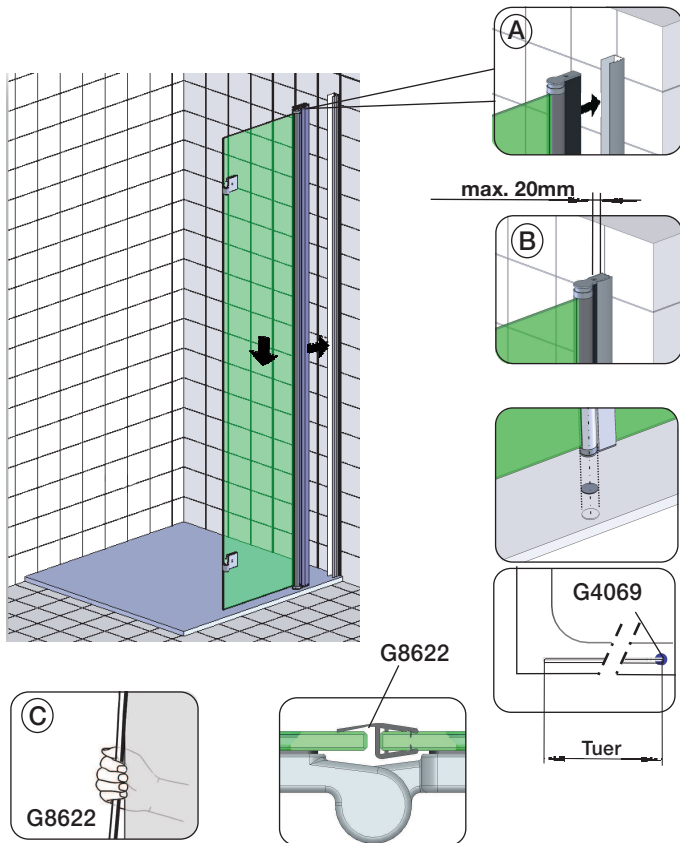

3

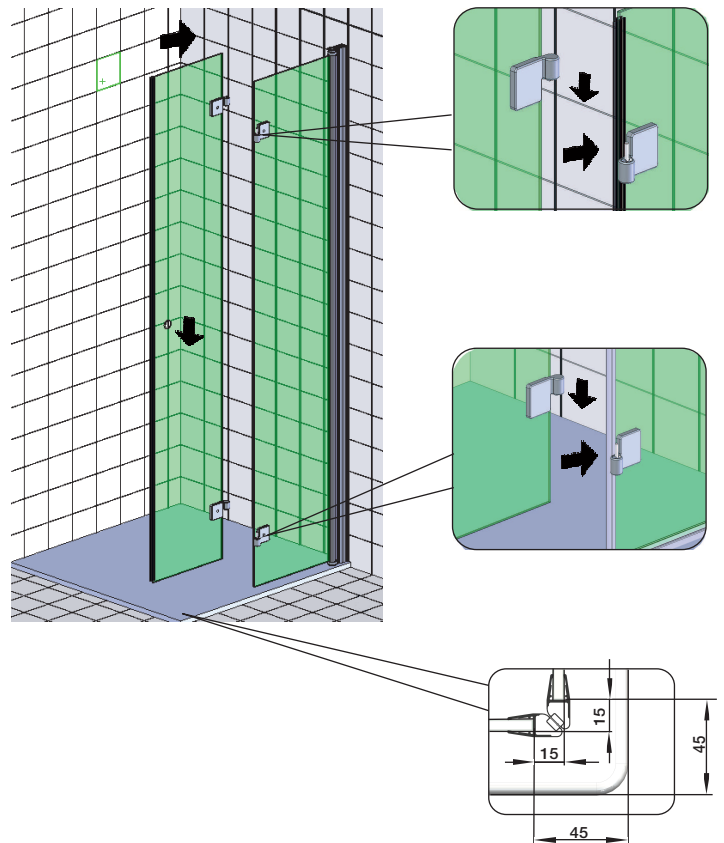

4

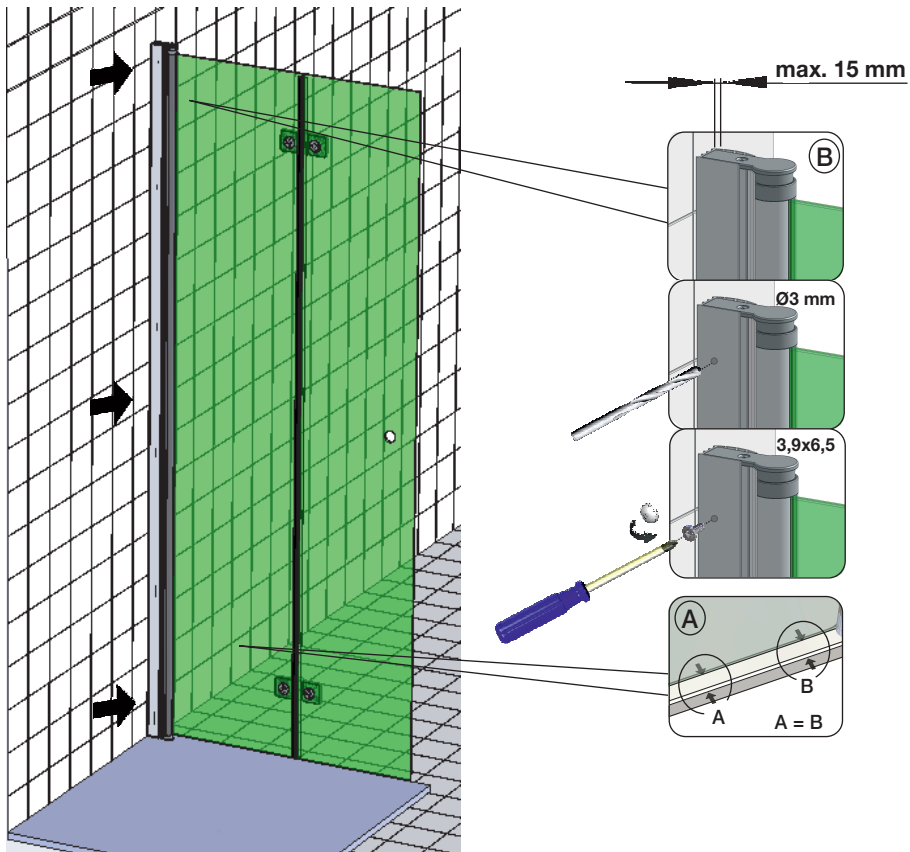

5

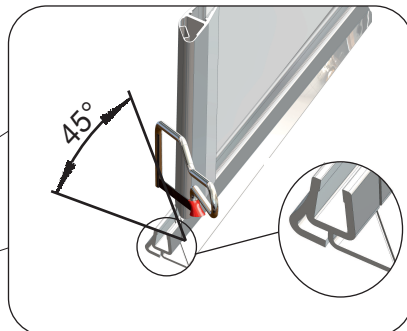
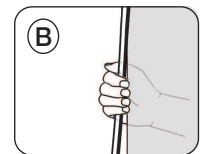
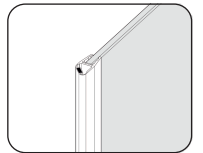
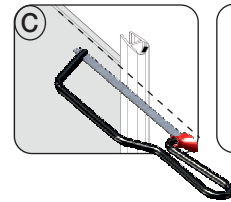
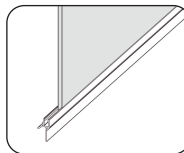
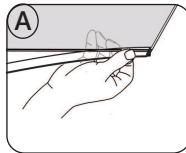
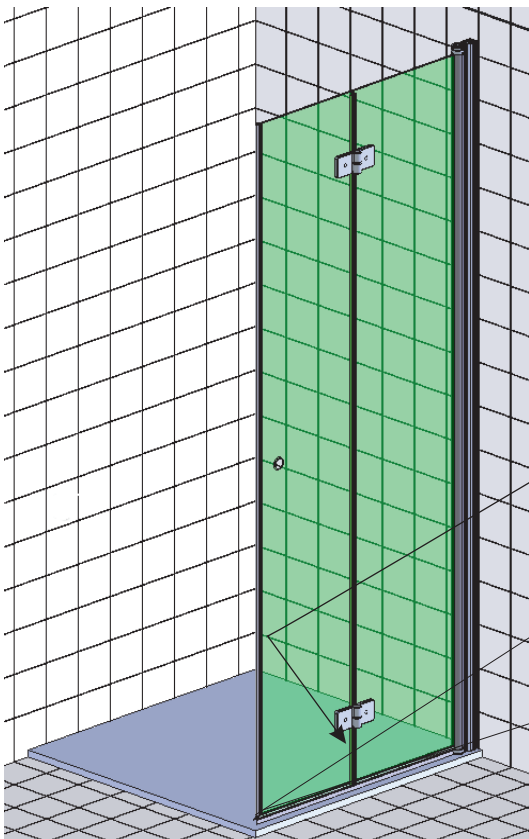

6

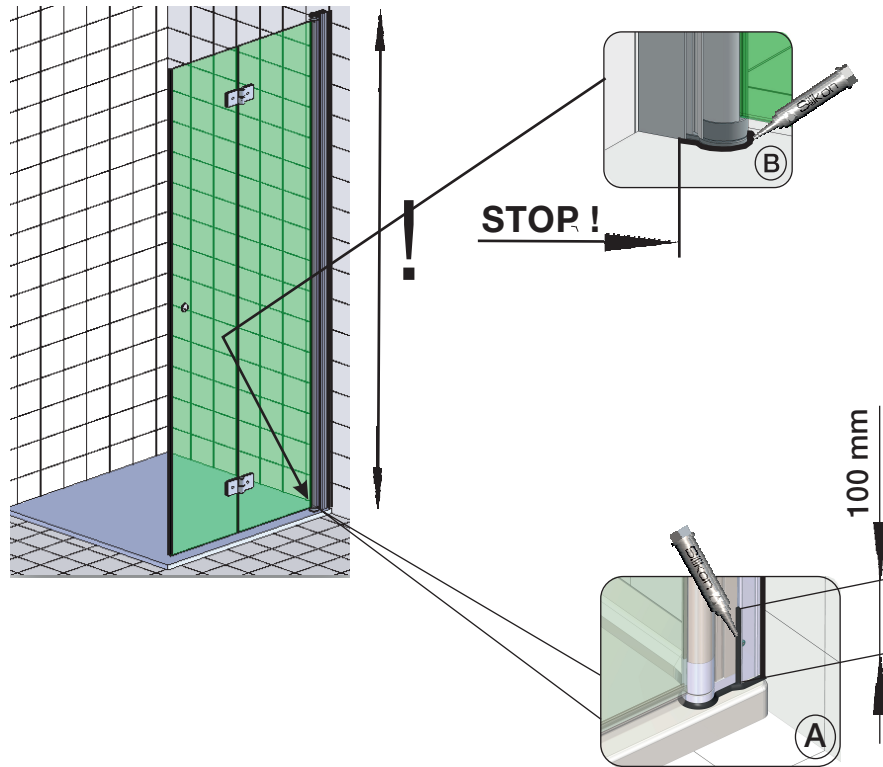

# Nischenmontage / MOUNTING WALL TO WALL

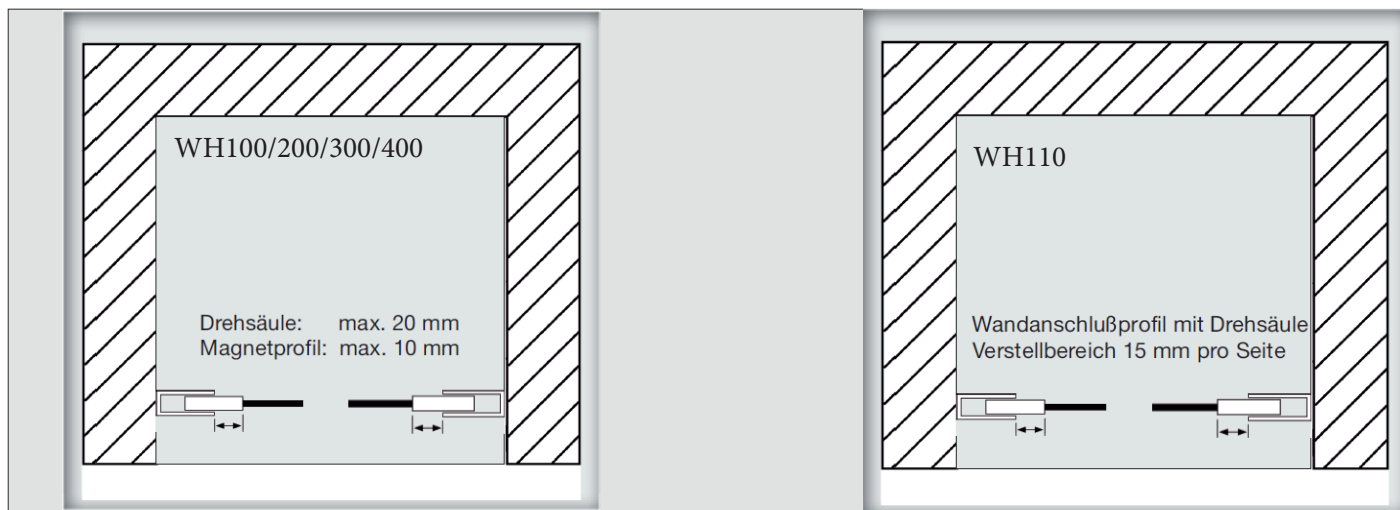

## Montage Fronteinstieg mit Seitenteil / Eckeinstieg / MOUNTING FRONT ENTRY/CORNER ENTRY

### Montage auf Duschtasse

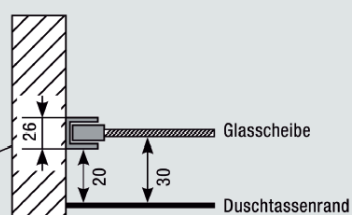
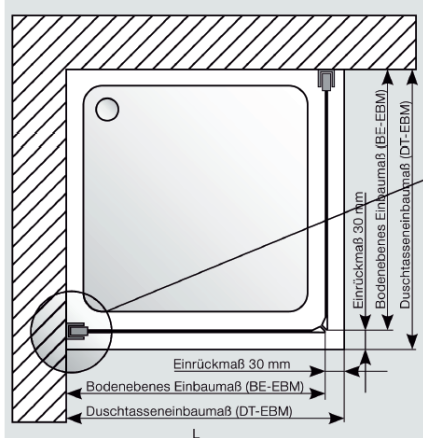

DT	DT-EBM	BE-EBM
800	785-805	755-775
900	885-905	855-875
1000	985-1005	955-975
1200	1185-1205	1155-1175
1400	1385-1405	1355-1375

### Montage Bodeneben

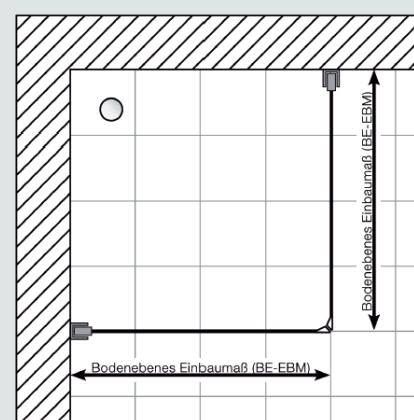

## Detail WH110 mit WHFST / DETAIL WH110 with WHFST

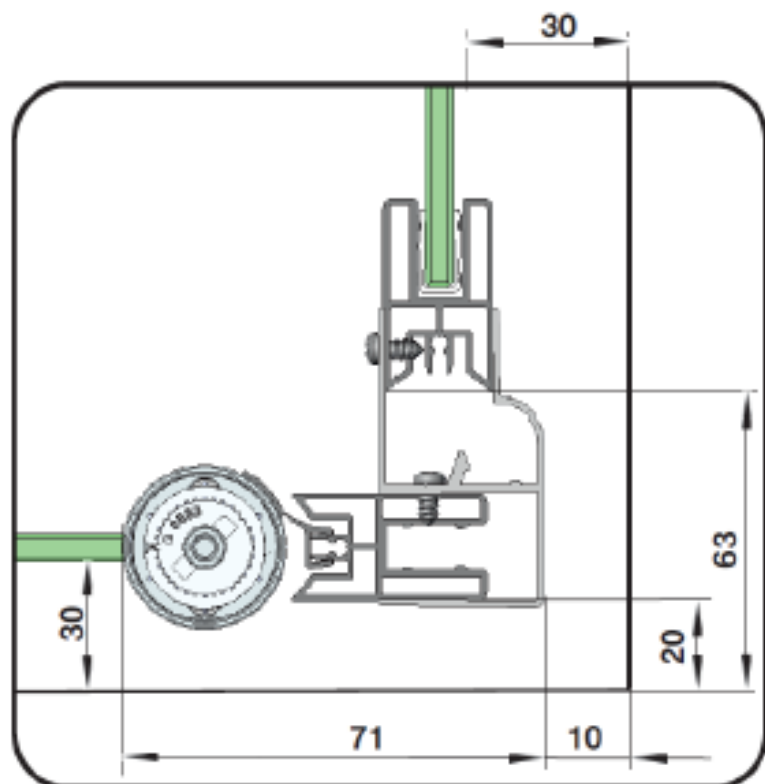

**EG-Konformitätserklärung**  
***EC Declaration of Conformity***

Hersteller/ Name und Adresse: GEO Produkte GmbH  
*Manufacturer/ name and address:* Friedrichsfelder Straße 27  
68723 Schwetzingen

Wir erklären in alleiniger Verantwortung:  
*We declare under our sole responsibility:*

Produktbenennung: Duschabtrennung mit ESG  
oder Kunststoffglas  
*product designation:* shower enclosure with  
tempered glass and acrylic-glass

Typ / Modell: alle Modelle  
*type / model:* all models

stehen in Übereinstimmung mit den Bestimmungen der im Folgenden  
genannten Richtlinie und Standards:  
*are in conformity with the provisions of the following regulations and  
standards:*

**EN 14428:2004 + A1:2008**



GEO Produkte GmbH  
Friedrichsfelder Straße 27  
68723 Schwetzingen /Germany  
Tel. +49(0)6202 20930  
FAX +49(0)6202 209399

13

DE2013/01

[www.geoprodukte.com/service/leistungserklärung.html/](http://www.geoprodukte.com/service/leistungserklärung.html/)

EN 14428

**Duschabtrennung** mit Einscheiben Sicherheitsglas oder Kunststoffglas  
**Shower wall** made of ESG tempered safety glass or sythetic glass

Reinigbarkeit:  
*cleanability:* Bestanden  
passed

Bruch Eigenschaften:  
impact resistance: Bestanden  
passed

Dauerhaftigkeit:  
durability: Bestanden  
passed