

LKZ:80461

Modellname / Model name / Nom du modèle / Modellnamn
 Nome modello / Název modelu / Modelnaam / Ime modela
 Numéro Modèle / Modell neve / Название модели /
 Názov modelu / Ime modela / Denumire model /
 Наименование на модела / Nazwa modelu

MARLON

Modellnummer / Number / Numéro du modèle
 Numero / Номер на модела / modello
 Číslo modelu / Modell száma / Éíslo modelu
 Številka modela / Număr model / Broj modela
 Modelnummer / Numer modelu

2222-481-01

Type / Tipo / Tipus / Typ / Тип / Tip

481

02.10.2023

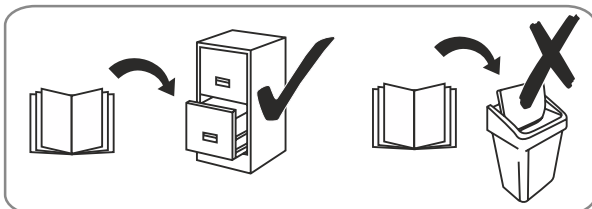
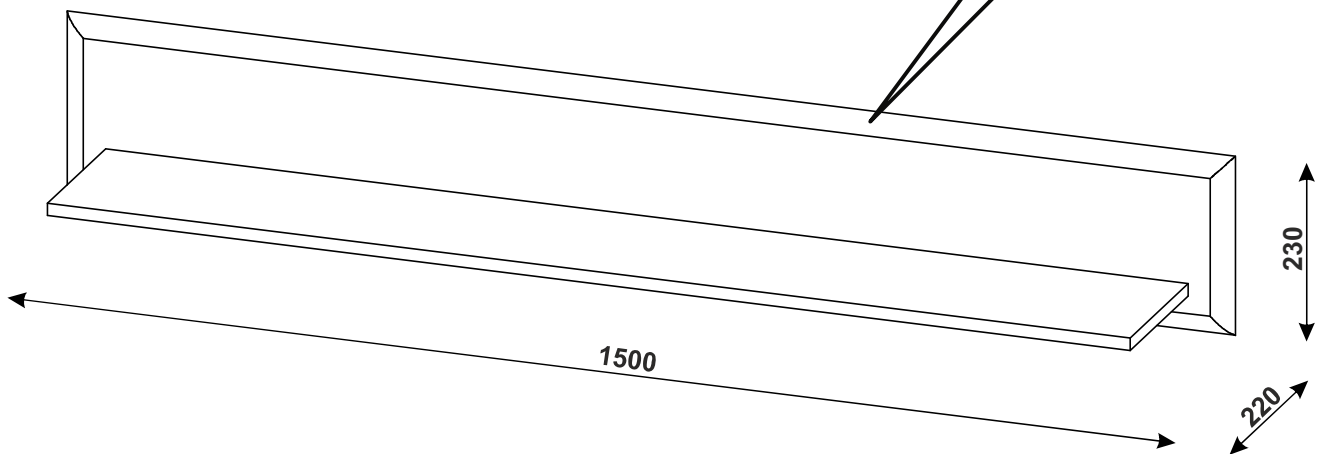
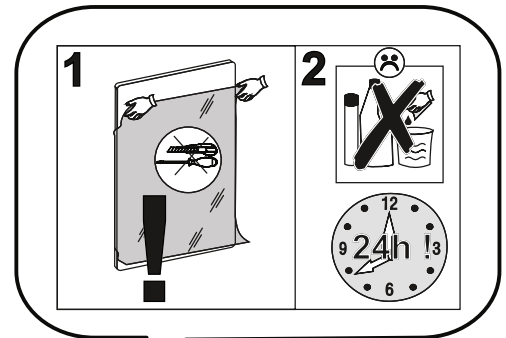
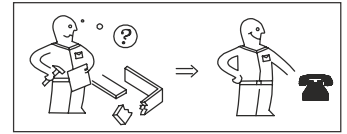
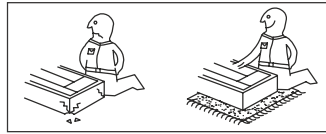
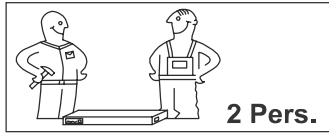
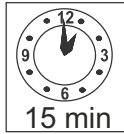

**Wichtig - Für spätere Verwendung
 aufbewahren - sorgfältig lesen!**

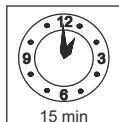
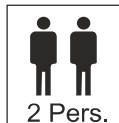
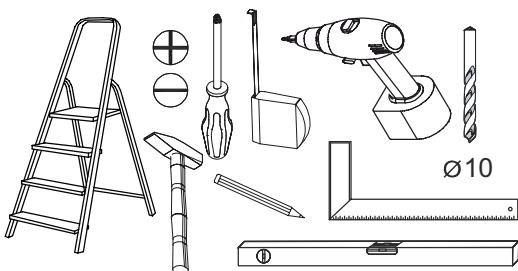

festziehen / tighten / Затягнете /
 serrer / stringere / utåhnut / vastrekken /
 zategnuti / strångere / zwiázac / zacišnaç
 szorosan meghúzni / pevne dotáhnut /
 trdno pritegniti / затянуть / dra át



eindrücken / press in / enfoncer / wcisnaç
 ribattere / zallaçiti / Вкарайте / indrukken
 benyomni / stlaçiti / vtsniti / tryck in
 introducere prin apăşare / вдавить



ausmessen / measure / mesurer /
 misurare / opmeten / izmeriti / miara /
 kimérni / izmeriti / măşurare / измерить
 změřit / Измерете / mät upp / zmierzyc



drücken / press / presser / stisknout /
 Натиснете / vtsniti / nasinaç / drukken /
 pritisnuti / nacisnaç / pritisniti / нажатъ /
 (meg)nyomni / apăşare / tryck fast / nacisnaç



einschlagen / hammer in / beverni / slå in
 frapper au marteau / infossare / Zabit' /
 zarazit / Набийте / zabiti / wbiç
 introduce prin bătaie / забить / zatlouct



Drehen - wenden / przekreçiti - odwróciç /
 Keren - omdraaien / Girare - Ruotare /
 Okrenuti - ubnuti / Retourner - renverser /
 Turn over - turn around / Otoçte - obratne /
 Завъртете - обвъртете / Obrnite list /
 Introarçeiti - rotiți / Vrid runt - vänd /
 прокрутите - повернуть / otoçiti - obrátit
 elforgatni - megfordítani

LKZ:80461

Modellname / Model name / Nom du modele / Modellnamn
Nome modello / Název modelu / Modelnaam / Ime modela
Numéro Modello / Modell neve / Название модели /
Názov modelu / Ime modela / Denumire model /
Наименование на модела / Nazwa modelu

MARLON

Modellnummer / Number / Numéro du modele
Numero / Номер на модела / Modello
Ěíslo modelu / Modell száma / Eíslo modelu
Ěíselvika modela / Numár model / Broj modela
Modelnummer / Numer modelu

2222-481-01



Type / Tipo / Típus / Typ / Тип / Tip

481

02.10.2023

D Unser Direktservice für Beschlagteile
Sollte Ihnen ein Beschlagteil fehlen, können Sie diese Servicekarte direkt an die untenstehende Adresse mailen. Wir können allerdings nur Beschlagteile auf diesem Wege verschicken. Sollten Sie eine andere Beanstandung an Ihrem Möbelstück haben, so wenden sie sich bitte direkt an Ihr Möbelhaus.

GB Our direct order service for fitting
If a fitting part is missing, you can e-mail this service card directly to the address below. However, we can only send fitting parts in this way. If you have any other cause for complaint concerning your item of furniture, please contact your furniture store directly.

CZ Naše přímé služby pro kování
Chybí-li vám nějaký díl z kování, můžete tuto servisní kartu odeslat e-mailem přímo na níe uvedenou adresu. Touto cestou však máme rozesílat jen díly kování. Pokud byste reklamovali jiný díl nábytku, obraťte se přímo na svého prodejce nábytku.

F Bien étudier la notice de montage
S'il vous manque une ferrure, veuillez envoyer directement la présente carte service à l'adresse e-mail indiquée ci-dessous. Cependant, ceci nous permet uniquement d'envoyer des ferrures. Pour tout autre type de réclamation concernant votre meuble, veuillez contacter directement votre magasin d'ameublement.

I Il nostro servizio diretto per l'ordine della ferramenta
Qualora Vi dovesse mancare un pezzo di fissaggio, allora Vi preghiamo di inviare questa carta di servizio immediatamente all'indirizzo sottostante. Possiamo inviare i pezzi di fissaggio solamente per mezzo di questo procedimento. Qualora dovete avere qualche altra reclamazione in merito al mobile, allora Vi preghiamo di rivolgere i direttamente al Vostro Negozio di mobili.

BG Нашата директна услуга за обков
Ако липсват части от комплекта, попълнете настоящата сервисна карта и ни я изпратете на e-mail адреса, посочен по-долу. По този начин можем да доставяме само липсващи елементи от обкова. Ако установите други дефекти по мебелите, Ви съветваме да се обърнете към мебелната къща/магазин, от който сте закупили стоката.

NL Onze directservice voor losse onderdelen
Wanneer er een onderdeel ontbreekt, kunt u deze servicekaart direct aan onderstaand e-mailadres sturen. Wij kunnen langs deze weg echter alleen beslagdelen versturen. Mocht u een ander probleem aan uw meubel hebben, verzoeken wij u contact op te nemen met uw meubeldealer.

PL Nasz bezpośredni serwis części montażowych
Jeżeli brakuje części koniecznych do montażu, prosimy o przesłanie nam niniejszej karty serwisowej na niżej podany adres e-mailowy. W ten sposób możemy przelać Państwu tylko brakujące części. W przypadku innych reklamacji dotyczących mebla, prosimy zgłosić się do salonu meblowego, w którym został dokonany zakup.

HR Servis za okove
U slučaju da nedostaje neki od dijelova molimo vas da na dole navedenu mail adresu pošaljete ovaj servisni obrazac. Na ovaj način mogu se dostaviti samo okovi. U slučaju da imate dodatne prigovore vezane uz komad namještaja molimo vas da se obratite izravno trgovini namještaja gdje je isti kupljen.

HU Direktszoigálatunk vasalatok esetén
Ha hiányzik egy vasalat, ezt a kártyát közvetlenül elküldheti az alább található címre. Azonban csak vasalatoskat tudunk így küldeni. Amennyiben másfajta reklamáció áll fenn bútordarabját illetően, forduljon közvetlenül a bútortházhoz.

SK Náš priamy servis pre časti kovania
Ak by Vám chýbala nejaká časť kovania, môžete poslať túto servisnú kartu poslať e-mailom na nižšie uvedenú adresu. Díly kovania vieme poslať iba týmto spôsobom. Ak by ste mali inú reklamáciu ohľadom Vášho nábytku, obráťte sa priamo na Vašu predajňu nábytku.

SLO Naše direktne uslune storitve za okovje
Ce vam manjka kakšno okovje, lahko to servisno kartico pošljete po e-pošti direktno na spodnji naslov. Po tej poti vam lahko pošljemo samo okovje. Ce elite reklamirati kakšnen drug del pohištva, se obrnite neposredno na vašo trgovino pohištva.

RO Service-ul nostru direct pentru feronerie
În cazul în care vă lipsește o piesă de feronerie puteți să trimiteți direct acest card de service prin e-mail la adresa de mai jos. Noi nu putem expedia piese de feronerie decât pe această cale. Dacă aveți o altă reclamație referitoare la piesa de mobilier, atunci vă rugăm să vă adresați direct la magazinul dvs. de mobilă.

RUS Наш прямой сервис для поставок фурнитуры
Если окажется, что Вам не хватает того или иного элемента фурнитуры, Вы можете отправить сервисную карту по факсу непосредственно на нижеприведенный адрес электронной почты. Однако, таким образом мы можем пересылать лишь фурнитуру. Если же у Вас возникнут иные претензии относительно приобретенной мебели, пожалуйста, обращайтесь непосредственно в организацию, осуществившую продажу.

S Vår direktservice för beslagsdelar
Om du saknar en beslagsdel kan du skicka detta servicekort direkt till e-postadressen som anges nedan. Tänk på att detta är den enda möjligheten att skicka beslagsdelar till dig. Om du vill reklamera din

ES Nuestro servicio directo para accesorios
Si le falta algún accesorio, puede enviar esta tarjeta de servicio directamente a la siguiente dirección. No obstante, por este método solo podemos enviar accesorios. Si tiene alguna otra objeción sobre su mueble, consulte directamente con su mueblería.

TR Donatılar için doğrudan servisimiz
Bir donatınız eksikse bu servis kartını doğrudan aşağıda bulunan adrese doğrudan mail yazabilirsiniz. Sadece bu yolla donatılar gönderiliriz. Mobilyanızda başka şikayetleriniz varsa lütfen doğrudan mobilya satıcınıza danışın.

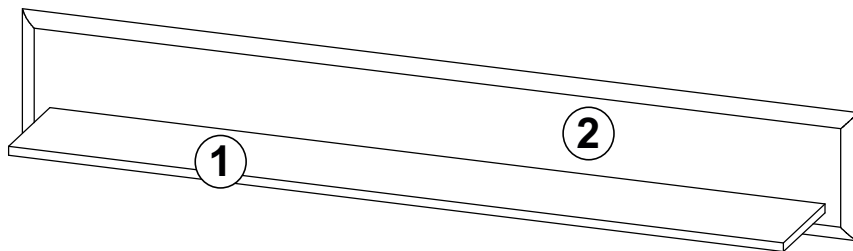
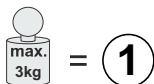

Nr.	Maße mm	Colli	Anzahl
1	1390 204	16	1/1 1
2	1500 230	16	1/1 1
B1			1/1 1

Grund der Beanstandung / Cause for complaint:

Möbelhaus / Furniture store:

Kunde / Customer :

Telefon / Telephone:

PLZ / Postcode :

Ort / City:

Str. +Nr / Street address :

@E-Mail:

LKZ:80461

Modell name/Model name/Nom du modele/Modellnamn
Nome modello/Název modelu/Modelnaam/Ime modela
Número Modelo/ Modell neve/ Название модели /
Názov modelu/Ime modela/Denumire model/
Наименование на модела /Nazwa modelu

MARLON

Modellnummer/Number/Numérodumodele
Numero/ Номер на модела/modello
Číslo modelu/Modell száma/Eíslo modelu
Številka modela/ Număr model /Broj modela
Modellnummer/Number/Numérodumodele







2222-481-01

Туре/Тіпо/Тіpus/Тур/Тип/Тіп

481

02.10.2023

B1 (COLLI 1/1)

A0	B1	D21	E5	M2	Z
					
Ø8x35	Ø6,4x50	5x11	10x50 6x55		4mm
x5	x6	x4	x2	x2	x1

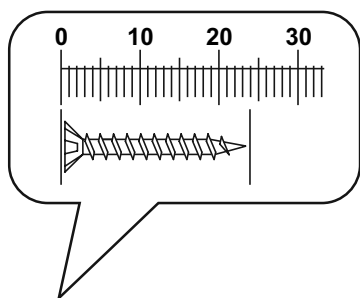

DE	BG	CS	EN
<p>Sehr geehrte Kundin, sehr geehrter Kunde, wir danken Ihnen für den Kauf eines Möbels aus unserem Innenraum-Programm zum ausschließlichen Gebrauch im privaten Räumlichkeiten. Bitte prüfen Sie den Lieferumfang auf Vollständigkeit und lesen Sie sich nachstehende wichtige Informationen vor der Montage sorgfältig durch und bewahren Sie diese für spätere An-/Verwendungen, auch durch Dritte, auf.</p> <p>Unsere Möbelstücke sind bestimmungsgemäß einzusetzen. Die nicht bestimmungsgemäße Verwendung kann zu Sachschäden oder unter Umständen zu Personenschäden führen. Möbel sind keine Kinderspielzeuge. Für Schäden, die durch nicht bestimmungsgemäßen Einsatz oder durch falsche Handhabung entstehen, übernimmt der Hersteller oder Händler keine Haftung.</p> <p>A C H T U N G: Kinder oder Personen mit geistiger Behinderung sind stets von Möbelteilen, spitzen Gegenständen, Kleinteilen und Verpackungsmaterialien fernzuhalten, es besteht Verletzungs- und/oder Erststichungsgefahr.</p> <p>M O N T A G E: Bitte richten Sie sich bei der Montage nach unseren Betriebs-, Bedienungs-, Installations- oder Montageanleitungen und achten Sie insbesondere auf Warn- und Sicherheitshinweise. Werden Anweisungen nicht befolgt, kann dies zu Verletzungen bei Personen oder zu Schäden am Möbel führen / zu einem Sicherheitsrisiko werden. Sollten Sie Schwierigkeiten beim Aufbau / bei der Montage haben, kontaktieren Sie bitte unser Serviceteam. Dieses steht Ihnen mit Rat und Tat zur Seite. Die Montage darf nur durch fachkundige Personen durchgeführt werden. Bei Änderungen am Produkt/Produktteilen, beim Austausch bzw. Einsatz von Teilen / Verbrauchsmaterialien, die nicht vom Hersteller/Händler stammen, kann keine Haftung für Schäden übernommen werden.</p> <p>Wenn der Ware Wandbefestigungsmittel wie Dübel und Schrauben beiliegen, sind diese ausschließlich zur Anwendung an Wänden aus massiven und einheitlichen Materialien bestimmt. Eine Befestigung ist nur so gut wie die Verbindung zwischen Befestigungsmittel und Wand. Bitte prüfen Sie sowohl bei stehenden als auch bei hängenden Möbelstücken vor deren Befestigung Ihre Wand auf ihre diesbezügliche Eignung und verwenden Sie nur dafür geeignete Befestigungsmittel. Vor eventuellen Bohrarbeiten vergewissern Sie sich, dass keine Leitungen im Bohrbereich liegen. Letztendlich ist der Monteur für die Befestigung an der Wand verantwortlich.</p> <p>Dies betrifft auch die Installation von Elektroartikeln sowie anderen bautechnischen Zubehörfteilen. Die Montage / Installation von Elektroartikeln sowie anderem baurelevanten Zubehör sind nur von autorisierten Fachpersonal durchzuführen. Alle elektrischen sowie bautechnischen Installationen sind nach den jeweils gültigen Normen bzw. Sicherheitsvorschriften in Ihrem Bundesland durchzuführen. Bitte setzen Sie bei Lichtquellen nur zulässige Leuchtmittelstärken ein. Bei Nichterhaltung der max. Wattzahl besteht durch Überhitzung Brandgefahr. Das Abdecken der Leuchtmittel ist wegen Brandgefahr zu unterlassen.</p> <p>Die einwandfreie Funktion des Möbels ist nur bei lot- und waagerechter Aufstellung gewährleistet. Die Türen sind vorjustiert, müssen aber ggf. aufgrund örtlicher Bedingungen neu ausgerichtet / eingestellt werden. Halten Sie bitte die Gewichtsangaben zur maximalen Belastung unbedingt ein. Möbel dürfen nicht bestiegen werden. Bei unsachgemäßem Gebrauch, kann es zu einem Umkippen von Möbelstücken kommen. Um dem vorzubeugen, sollten Möbel stets gegen Umkippen gesichert werden. Bei Überlastungen/Überbelastungen (insbesondere durch spielende Kinder, Menschen, Material oder sonstige unsachgemäße Einwirkungen) besteht erheblicher Bruch- und Verletzungsgefahr. Alle Schrauben sowie tragende Verbindungsstellen sollten nach 5 bis 6 Wochen nachgezogen werden, um eine dauerhafte Standsicherheit zu gewährleisten.</p> <p>P F L E G E: -Hinweise zur Möbelpflege- Beachten Sie bitte unsere Hinweise zur richtigen Möbelpflege, damit Sie möglichst lange Freude an unserem Produkt haben. Verwenden Sie bei der Reinigung ein sauberes, trockenes und weiches Baumwolltuch. Wenn Ihre Möbel einer gründlichen Reinigung bedürfen, können Sie das Tuch mit etwas Wasser oder Möbelreinigungsmittel befeuchten und anschließend die gereinigten Elemente trocken. Metall- und Glasteile reinigen Sie am besten mit den handelsüblichen Metall- und Glasreinigern nach den auf ihnen befindlichen Pflegeanweisungen. Die Reinigungsmittel müssen einen klaren Hinweis tragen, dass sie zur Möbelpflege geeignet sind. Verwenden Sie auf gar keinen Fall Dampfreiniger sowie ätzende, scheuende und andere Mittel, deren Wirkung Sie nicht kennen.</p> <p>A C H T U N G: Hochglanzoberflächen sind bei der Auslieferung durch eine Schutzfolie geschützt. Belassen Sie diese auf dem Möbel, bis es vollständig montiert und von Staub befreit ist. Hochglanzelemente, von denen die Schutzfolie entfernt wurde, dürfen erst nach 72 Stunden (Zeit zum Nachhärtan an der Raumluft) gereinigt und verwendet werden. Oberflächen nicht mit scharfen Gegenständen beschädigen und keinesfalls starker Sonnenbestrahlung aussetzen.</p> <p>E N T S O R G U N G: -Hinweise zur Abfallentsorgung- Der Umwelt zuliebe entsorgen Sie bitte den Verpackungsmüll sortenrein in die dafür vorgesehenen Abfall-/ Recyclingtonnen und nicht in die Natur. Beschädigte oder unbrauchbare Möbel können speziellen Wiederverwertungsanlagen zum Recyceln von Einzelteilen zugeführt werden.</p> <p>Ausgediente, jedoch noch funktionstüchtige Möbel müssen nicht gleich entsorgt werden. Spenden Sie sie z. B. an wohltätige Organisationen.</p> <p>Wir wünschen Ihnen viel Freude mit Ihrem neuen Möbel.</p>	<p>Уважаеми клиенти, благодарим Ви, че закупихте мебели от нашата интериорна програма за обзавеждане на дома. Моля, проверете обхвата на доставката за пълнота, преди монтажа прочетете внимателно следната важна информация и я запазете за бъдещи справки, а също и за трети страни. Нашите мебели следва да се използват по предназначение. Неправилната употреба може да доведе до материални щети или при определени обстоятелства до физически наранявания. Мебелите не са детски играчки. Производителят или търговецът не поема отговорност за щети в резултат на употреба извън предназначението или неправилно боравене.</p> <p>В Н И М А Н И Е: Деца или лица с ментални увреждания следва винаги да се държат далече от части на мебелите, остри предмети, малки части и опаковъчни материали, съществува опасност от нараняване и/или задушаване.</p> <p>М О Н Т И Р А Н Е: Во време на монтажа, моля, съблюдавайте нашите ръководства за експлоатация, обслужване, инсталиране или събиране и обърнете особено внимание на предупрежденията и указанията за безопасност. Неспазването на указанията може да доведе до нараняване на лица или повреда на мебелите / да създаде риск за безопасността. Ако имате затруднения при събирането / монтажа, моля, свържете се с нашия сервизен екип. Той е на Ваше разположение със съвети и действия. Монтажът следва да се извършва само от квалифицирани лица. Не се поема отговорност за щети в случаи на модификации на продукта/части на продукта, при подмяна или използване на части / консумативи, които не са предоставени от производителя/търговеца.</p> <p>Ако към izdeliyata са приложени крепежни елементи за стена, като дюбели и винтове, те са предназначени за използване само за стени от масивни и еднородни материали. Закрепването е толкова добро, колкото е добра връзка между крепежния елемент и стената. Моля, проверете пригодността на Вашата стена преди закрепването както на стоящи, така и на окачени мебели и използвайте само подходящи крепежни елементи. Преди да започнете с пробиването, се уверете, че в съответната зона не преминават кабели. По принцип монтажникът е отговорен за закрепването към стената.</p> <p>Това се отнася и за инсталирането на електрически артикули и структурното окабеляване. Мониторинг / инсталирането на електрически артикули, както и на други конструктивни елементи, свързани със строителството, следва да се извършва само от оторизирани специализирани персонал. Всички електрически инсталации и структурно окабеляване следва да се изпълняват в съответствие с приложимите стандарти и разпоредби за безопасност във Вашата страна. Моля, използвайте само източници на светлина с допустимите стойности за сила на светлината. При неспазване на максималната мощност съществува опасност от пожар поради прегряване. Покриването на източниците на светлина не е разрешено поради опасност от пожар.</p> <p>Правилната функция на мебелите е гарантирана само при вертикално и хоризонтално положение. Вратите са регулирани предварително, но при необходимост в зависимост от местните условия може да се наложи да бъдат настроени/регулирани повторно. Моля, съблюдавайте стриктно спецификациите за максималното натоварване. Мебелите не са средство за катерене. При неправилна употреба мебелите могат да се преобърнат. За да се предотврати това, мебелите винаги трябва да се обезопасяват срещу преобръщане. При претоварване/свързотвар (по-специално поради играещи деца, хора, материали или други неподходящи въздействия) съществува опасност от счупване и нараняване. Всички винтове, както и носещите свързващи точки трябва да бъдат затегнати след 5 до 6 седмици, за да се осигури трайна стабилност.</p> <p>П О Д Р Ъ Ж К А: -Указания за поддръжка на мебелите- Моля, съблюдавайте указанията за правилна поддръжка на мебелите, за да можете да се наслаждавате на нашите продукти възможно най-дълго.</p> <p>За почистване използвайте чиста, суха и мека памучна кърпа. Ако Вашите мебели се нуждаят от основно почистване, можете да навлажните кърпата с малко вода или почистващ препарат за мебели и след това да подсушите почистените елементи. Метални и стъклени части се почистват най-добре със стандартни почистващи препарати за метал и стъкло съобразно посочените върху опаковките указания. Почистващите препарати трябва да са с ясно указание, че са подходящи за поддръжка на мебели.</p> <p>В никакъв случай не трябва да използвате парочистачка, корозиони, абразивни или други препарати, чието действие не Ви е познато.</p> <p>В Н И М А Н И Е: При експлоатацията повърхностите с висок гланц са защитени с предпазно фолио. Оставете го върху мебелите, докато те бъдат напълно монтирани и почистени от прах. Елементите с висок гланц, от които е отстранено предпазното фолио, могат да се почистват и използват едва след 72 часа (време за допълнително втвърдяване на въздъх в помещението).</p> <p>Не повреждайте повърхностите с остри предмети и в никакъв случай не ги излагайте на силна слънчева светлина.</p> <p>О Т С Т Р А Н Я В А Н Е К А Т О О Т П А Д Ъ К -Указания за отстраняването като отпадък- За опазване на околната среда, моля, изхвърляйте опаковките, сортирани по вид, в предвидените контейнери за отпадъци / рециклиране, а не в природата. Повредените или непотребните мебели могат да бъдат предадени в специални депа за оползотворяване и рециклиране на отделни части. Излезлите от употреба, но все още годни мебели не бива да се изхвърлят веднага. Дарете ги напр. на благотворителни организации.</p> <p>Пожелаваме Ви да се наслаждавате на новото обзавеждане.</p>	<p>Vážená zákaznice, vážený zákazník, děkujeme, že jste si zakoupili nábytek z našeho interiérového programu pro výhradní použití v soukromých prostorech. Zkontrolujte úplnost rozsahu dodávky a před montáží si pozorně přečtěte následující důležité informace a uchovávejte je pro pozdější využití/použití, a to i třetími osobami.</p> <p>Náš nábytek se musí používat podle předpisů. Používání v rozporu s předpisy může vést k věcným škodám a za jistých okolností také k zraněním osob. Nábytek není hračka. Za škody, které vzniknou použitím výrobků předpisům nebo nesprávnou manipulací, nepřijímá výrobce nebo prodejce žádnou záruku.</p> <p>P O Z O R: Děti nebo osoby s mentálními postiženími se musí neustále držet mimo dílů nábytku, špičatých předmětů, drobných částí a obalových materiálů, protože hrozí riziko zranění a/nebo udušení.</p> <p>M O N T Á Ž: Při montáži dodržujte náš návod k používání, obzvláště, instalaci nebo montáži a dbejte hlavně pozor na výstražná a bezpečnostní pokyny. Pokud se nebudou dodržovat předpisy, může to mít za následek zranění osob nebo poškození nábytku / ohrožení bezpečnosti. Pokud byste měli potíže s instalací/montáží, kontaktujte náš servisní tým. Tento vám ochotně poradí a pomůže. Montáž smí provádět pouze kvalifikovaný personál. Při změnách na produktu/dílech produktu, při výměně nebo použití dílů/spotřebních materiálů, které nepocházejí od výrobce/prodejce, nepřijímáme žádnou odpovědnost za škody.</p> <p>Pokud jsou ke zboží přiloženy upevňovací prvky na zeď, jako jsou hmoždinky a šrouby, jsou tyto určeny výhradně pro použití na stěnách z pevných a jednotných materiálů. Upevnění je jen tak dobré, jak dobré je spojení mezi upevňovacími prostředky a stěnou. Před upevněním musíte zkontrolovat vhodnost vaší stěny pro stojící i závěsný nábytek a použít pouze vhodné spojovací prvky. Před případným vtíráním se ujistěte, že se v oblasti vtírání nenachází elektrické vodiče. Nakonec je za upevnění na stěnu odpovědný instalační technik.</p> <p>Plati to také pro instalaci elektrických produktů a dalšího stavebně-technického příslušenství. Montáž/instalaci elektrických produktů a také dalšího důležitého konstrukčního příslušenství může provádět pouze autorizovaný kvalifikovaný personál. Veškeré elektrické a stavebně-technické instalace musí být provedeny v souladu s platnými normami a bezpečnostními předpisy ve vaší zemi. Pro světelné zdroje používejte pouze povolenou intenzitu osvětlení. Při nedodržení max. počtu Watt hrozí riziko požáru v důsledku přehřátí. Překrývání svítidel není povoleno z důvodu rizika požáru. Dokonalá funkce nábytku je zaručena pouze při vertikální a horizontální instalaci. Dveře jsou předem nastavené, můžou se ale znovu seřídit/nastavit na základě místních podmínek. Dodržujte údaje o hmotnosti pro maximální zatížení. Na nábytek se nesmí ležet. Při neodborném použití může dojít k převrácení nábytku. Aby se tomu zamezilo, musí být nábytek neustále zajištěn proti převrácení. Při přetíženi/nadměrném přetížení (zejména hrajícími si dětmi, lidmi, materiálem nebo jinými nevhodnými vlivy) hrozí riziko rozbití a zranění. Všechny šrouby a nosná spojovací místa by měla být dotažena po 5 až 6 týdnech, aby se zajistila trvalá stabilita.</p> <p>P Ě Č E: -Pokyny k péči o nábytek- Dodržujte naše pokyny pro správnou péči o nábytek, abyste si naš výrobek mohli užívat co nejdéle. Při čištění používejte čistou, suchou a měkkou bavlněnou hadičku. Pokud potřebuje váš nábytek důkladné vyčištění, můžete hadičku navlhčit trochou vody nebo čističím prostředkem na nábytek a pak vyčistěte věci vysušit. Kovové a skleněné díly se nejlépe čistí běžně dostupnými čističimi prostředky na kovy a sklo podle pokynů, které jsou na nich uvedené. Na čističích prostředcích musí být jasně uvedeno, že jsou vhodné k čištění nábytku. V žádném případě nepoužívejte parní čističe, žiraviny, abraziva nebo jiné prostředky, jejichž účinky neznáte.</p> <p>P O Z O R: Vysocce lesklé povrchy jsou při dodávce chráněny ochrannou fólií. Nechte fólii na nábytku, dokud nebude zcela smontován a zbaven prachu. Vysocce lesklé prvky, ze kterých byla odstraněna ochranná fólie, lze čistit a používat až po 72 hodinách (doba pro následné vytvrzení na okulim vzduchu). Povrchy nelze poškodit ostrými předměty a nikdy je nemůžete vystavovat silnému slunečnímu záření.</p>	<p>Dear valued customer, Thank you for purchasing furniture from our interior programme, exclusively for use in private rooms. Please check the delivery for completeness, carefully read the following important information prior to assembly and retain it for future use, also by third parties.</p> <p>Our furniture may only be used as intended. Improper use can cause damage to property, or personal injury under certain circumstances. Furniture is not a toy. The manufacturer or distributor assumes no liability for damage caused by unintended use or improper handling.</p> <p>ATTENTION: Children or persons with a mental disability must be kept away from furniture components, sharp objects, small parts and packaging materials at all times. There is a risk of injury and/or suffocation.</p> <p>ASSEMBLY: Please observe our operating, assembly or installation instructions for assembly and observe the warnings and safety instructions in particular. Failure to follow instructions may lead to personal injury or damage to the furniture, and can pose a safety risk. Please contact our service team if you have problems with setup/assembly. They will be happy to help you. Assembly may only be carried out by competent persons. No liability for damage is assumed in case of changes to the product/product components or the replacement/use of parts/consumables not provided by the manufacturer/distributor. If wall mounting materials such as dowels or screws are included with the product, these are intended exclusively for use on solid walls made of uniform materials. Attachment is only as good as the connection between the mounting materials and the wall. For both standing and hanging furniture, check your wall for suitability prior to attachment and only use suitable mounting materials. Ensure there are no lines in the drilling zone before drilling any holes. Ultimately, the installer is responsible for the attachment to the wall.</p> <p>This also applies to the installation of electrical appliances and other structural accessories. The assembly/installation of electrical appliances and other structural accessories must be performed exclusively by authorised, qualified personnel. All electrical and structural installations must be carried out according to the respective applicable standards and safety regulations in your federal state. Only use approved illuminants for light sources. There is a risk of overheating and fire if the maximum wattage is exceeded. Covering illuminants is prohibited due to the risk of fire.</p> <p>Proper functioning of the furniture requires plumb and horizontal alignment. The doors are pre-adjusted, but may have to be re-adjusted due to local conditions. Be sure to observe the weight specifications for maximum loads. Climbing on furniture is prohibited. Furniture may tip over in case of improper use. To prevent this, furniture should always be secured against tipping over. There is a risk of breakage and injury in case of overloading (in particular by playing children, people, materials or other prohibited loads). All screws and load-bearing connections should be re-tightened after 5 to 6 weeks to ensure permanent stability.</p> <p>CARE: - Notes on furniture care - Please observe our information on proper furniture care to ensure you can enjoy our product for a long time. Use a clean, dry, soft cotton cloth for cleaning. If your furniture is heavily soiled, you may moisten the cloth with some water or furniture cleaner and dry the cleaned elements afterwards. Metal and glass components are best cleaned with conventional metal and glass cleaners according to the instructions provided for them. The cleaning agents must be clearly identified as being suitable for furniture care. Do not use steam cleaners, corrosive, scouring cleaning agents or other cleaners with unknown effects under any circumstances. ATTENTION: High-gloss surfaces are covered by a protective film on delivery. Leave this on the furniture until it has been fully assembled and dusted. Once the protective film is removed, high-gloss elements may only be cleaned and used after 72 hours (time for post-curing in room air). Do not damage surfaces with sharp objects and never expose them to strong sunlight.</p> <p>DISPOSAL - Notes on waste disposal - For the good of the environment, please sort the packaging for disposal, use the waste/recycling bins provided and do not litter. Damaged or unusable furniture can be recycled by special facilities for the recycling of components. Discused furniture that is still functional does not have to be discarded. Consider donating it to a charitable organisation.</p> <p>We hope you enjoy your new furniture.</p>

Değerli müşterimiz, evde kullanım için tasarlanan iç mekan programımızdan bir mobilya satın aldığınız için teşekkür ederiz. Lütfen teslimat kapsamının eksiksiz olup olmadığını kontrol edin ve montajdan önce aşağıdaki önemli bilgileri dikkatlice okuyun ve daha sonra üçüncü şahıslar tarafından da kullanılmak üzere saklayın.

Mobilyalarımız amaçlandığı şekilde kullanılmalıdır. Amacı dışında kullanımı, maddi hasarlara veya bazı durumlarda kişisel yaralanmalara neden olabilir. Mobilyalar çocuk oyuncakları değildir. Üretici veya satıcı, amacı dışında veya yanlış kullanımdan kaynaklanan hasarlar için hiçbir sorumluluk kabul etmez.

D İ K K A T: Çocuklar veya zihinsel engelli kişiler, yaralanma ve/veya bozulma riski bulunduğundan, mobilya parçalarından, sivri uçlu nesnelere, küçük parçalardan ve ambalaj malzemelerinden daima uzak tutulmalıdır.

M O N T A J: Montaj sırasında lütfen işletim, kullanım, kurulum veya montaj talimatlarınıza uyun ve uyan ve güvenlik talimatlarına özellikle dikkat edin. Talimatlara uyulmaması, kişisel yaralanmaya veya mobilya hasarına/güvenlik riskine neden olabilir.

Montaj / kurulum konusunda zorluk yaşıyorsanız, lütfen servis ekibimize iletişime geçin. Ekibimiz tavsiyeleriyle ve destekleriyle size yardımcı olacaktır. Montaj sadece uzman kişiler tarafından yapılmalıdır.

Ürün/ürün parçalarında değişiklikler, üreticiden/satıcıdan gelmeyen parçalarla/sarf malzemeleriyle değiştirilmesi veya kullanılması durumunda meydana gelebilecek hasarlar için sorumluluk kabul edilmez.

Ürünlere dübel ve vida gibi duvara sabitleme araçları eklenmişse, bunlar sadece sağlam ve tek tip malzemelerden yapılmış duvarlarda kullanılmak üzere tasarlanmıştır. Bir bağlantı sadece bağlantı elemanı ve duvar arasındaki bağlantı kadar iyidir. Lütfen mobilyayı sabitlemeden önce duvarınızın hem ayakta hem de asılı mobilya için uygunluğunu kontrol edin ve sadece uygun bağlantı elemanları kullanın. Olası bir delme işleminden önce delme alanında tesiat olmadığının emin olun. Sonuçta, montajı yapan kişi duvara sabitlemekten sorumludur.

Bu aynı zamanda elektrikli parçaların ve diğer yapısal aksesuarların montajı için de geçerlidir. Elektrikli parçaların ve diğer ınsaatla ilgili aksesuarların montajı/kurulumu sadece yetkili uzman personel tarafından yapılabilir. Tüm elektrik ve yapısal kurulumlar, eyletinizdeki geçerli standartlara ve güvenlik yönetmeliklerine uygun olarak yapılmalıdır. Işık kaynakları için lütfen sadece izin verilen aydınlatma güçlerini kullanın. Maksimum Watt değerine uyulmaması durumunda aşırı ısınma nedeniyle yangın riski söz konusudur. Yangın tehlikesi nedeniyle aydınlatmaların üstünü kapatmak yasaktır.

Mobilyaların düzgün fonksiyonu sadece düz ve yatay konumda garanti edilir. Kapılar önceden ayarlanmıştır, ancak yerel koşullar nedeniyle yeniden hizalanması/ayarlanması gerekebilir. Lütfen maksimum yük ile ilgili ağırlık bilgilerine uyun. Mobilyaların üzerine çıkılması yasaktır. Yanlış kullanım mobilyaların devrilmesine neden olabilir. Bunu önlemek için mobilyalar her zaman devrilmeye karşı emniyete alınmalıdır. Aşırı yük/aşırı zorlama durumunda (özellikle oyun oynayan çocuklar, insanlar, malzeme veya diğer uygunsuz etkilere nedeniyle) kırılma ve yaralanma riski söz konusudur. Kalıcı sağlamlığı güvenceye almak için tüm vidalar ve yük taşıyan bağlantı noktaları 5-6 hafta sonra tekrar sıkılmalıdır.

B A K I M:
-Mobilya bakımıyla ilgili notlar-
Ürününüzün keyfini alabildiğince uzun süre çıkarabilmemiz için lütfen uygun mobilya bakımıyla ilgili talimatlarımızı dikkate alın.

Temizlik sırasında temiz, kuru ve yumuşak pamuklu bir bez kullanın. Mobilyanız kapsamı bir temizliğe ihtiyacı varsa, bezi biraz su veya mobilya temizleyicisiyle nemlendirebilir ve ardından temizlenen eşyaları kurutabilirsiniz. Metal ve cam parçaları, üzerindeki bakım talimatlarına göre piyasada bulunan metal ve cam temizleyicilerle en iyi şekilde temizleyebilirsiniz. Temizlik maddeleri, mobilya temizliği için uygun olduklarının açık bir göstergesini taşımaz.

Hiçbir koşulda buharlı temizleyiciler, kostik, aşındırıcı veya etkilene aşına olmadığınız diğer maddeleri kullanmamalısınız.

D İ K K A T: Çok parlak yüzeyler teslimat sırasında koruyucu bir folyoyla korunur. Bunu tamamen monte edilene ve tozu temizlenene kadar mobilya üzerinde bırakın. Koruyucu folyonun çıkarıldığı çok parlak elemanlar ancak 72 saat sonra temizlenebilir ve kullanılabilir (ortam havasında son katlaşma süresi). Yüzeylere keskin nesnelere zarar vermeyin ve asla güçlü güneş ışığına maruz bırakmayın.

T A S F İ Y E

-Tasfiyeyle ilgili notlar-
Çevre için lütfen türüne göre ayrılmış ambalaj atıklarını doğaya değil, bunlar için sağlanan atık/geri dönüşüm kutularında tasfiye edin.
Hasarlı veya kullanılmaz mobilyalar, her bir parçanın geri dönüştürülmesi için özel geri kazanım tesislerine gönderilebilir.

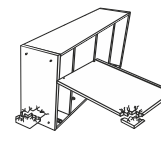
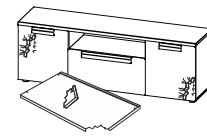
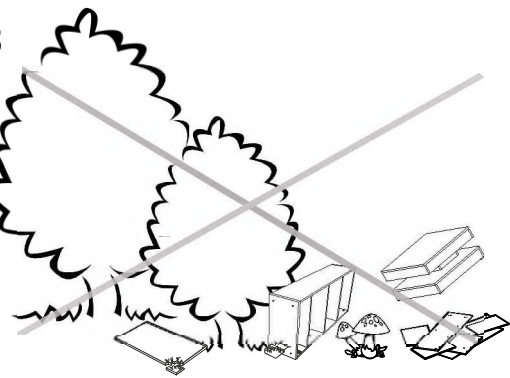
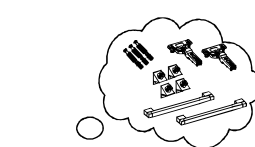
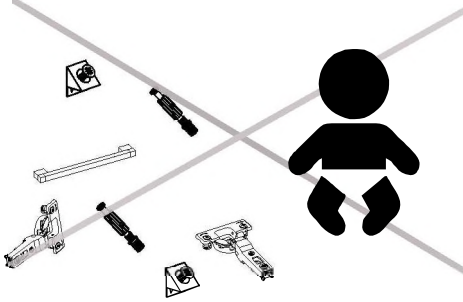
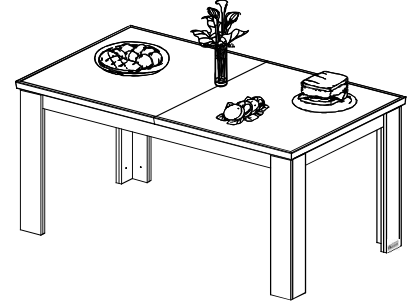
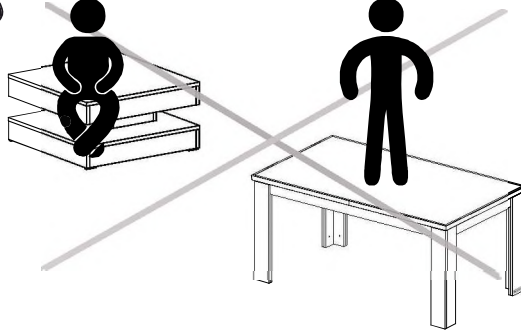
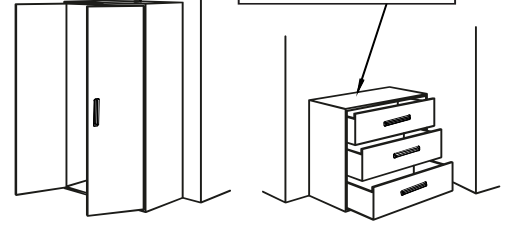
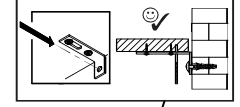
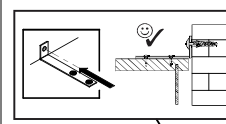
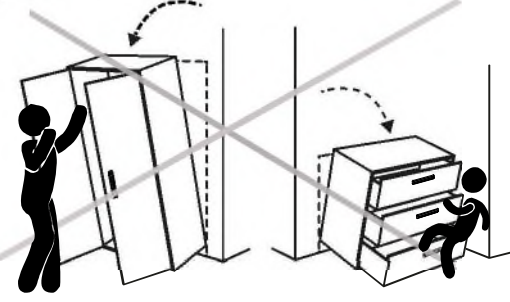

Artık kullanılmayan ancak hala işlevsel olan mobilyaların hemen tasfiye edilmesi gerekmez. Bunları örneğin hayır kurumlarına bağışlayın.

Yeni mobilyalarınızı güle güle kullanın.

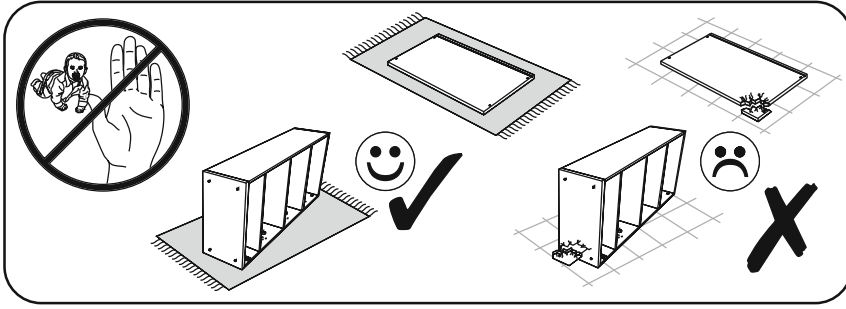

1



D21	M2
	
5x11	
x4	x2

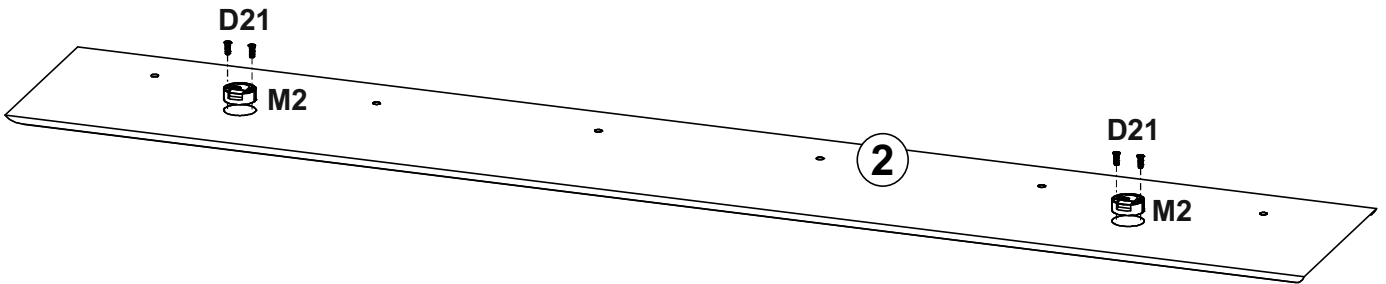
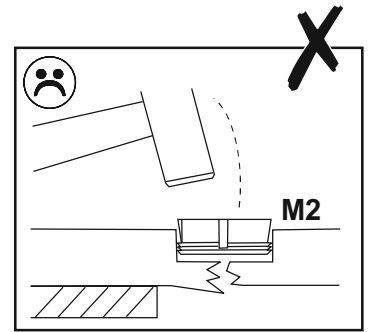
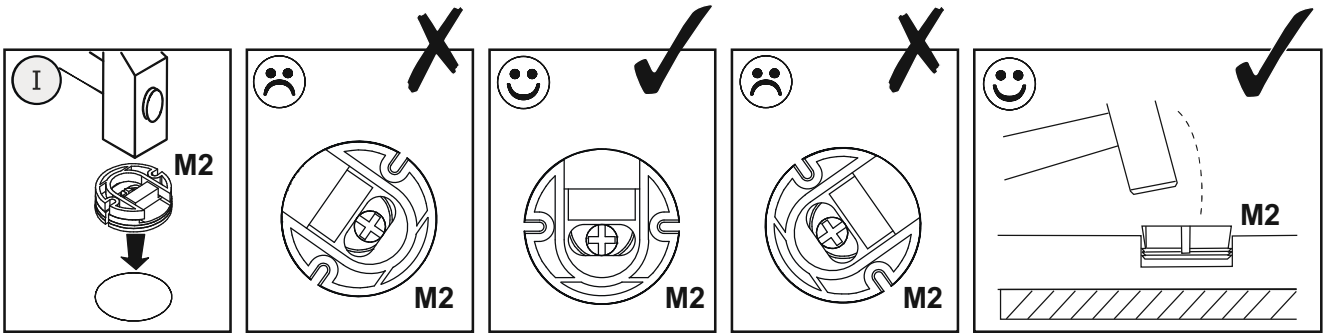

5x11



D21

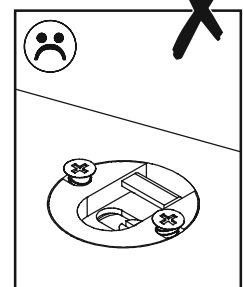
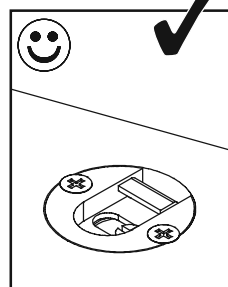
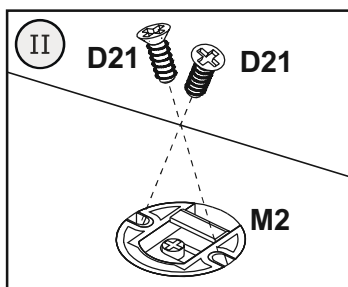
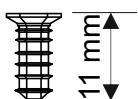

2

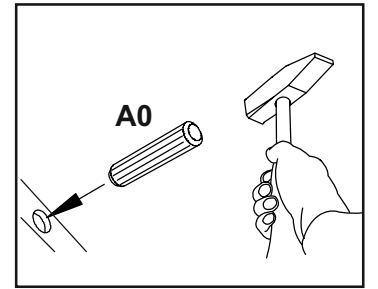
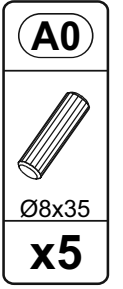
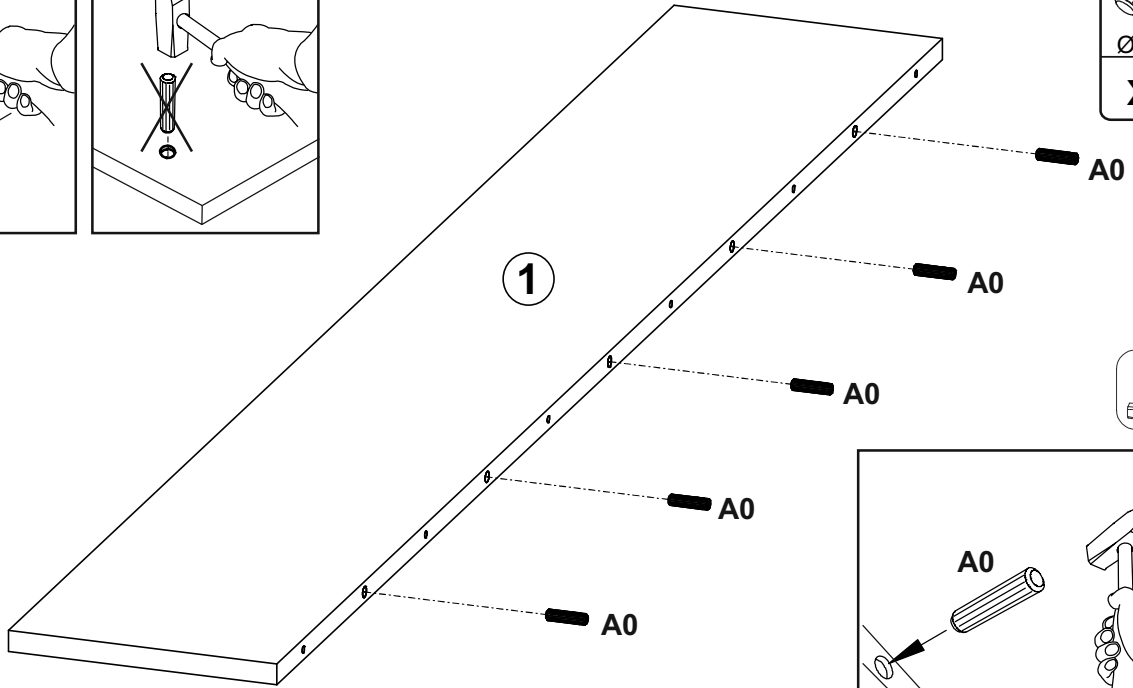
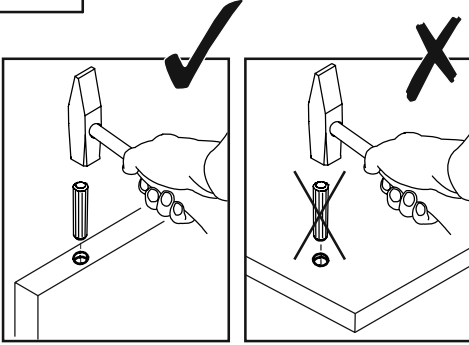

3

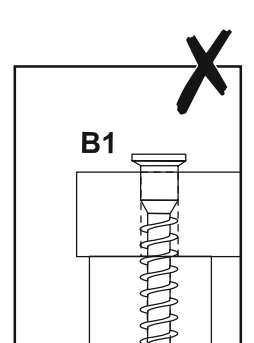
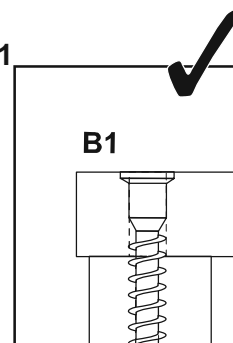
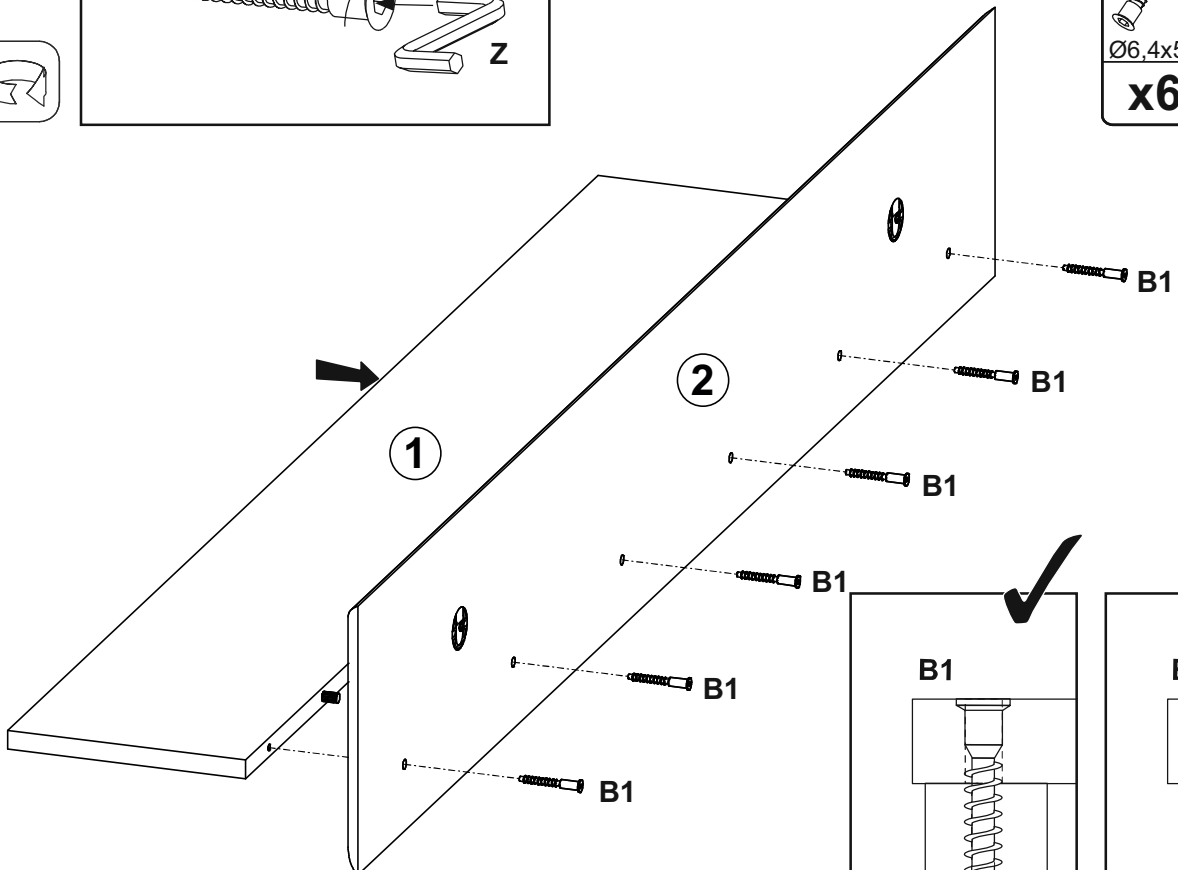
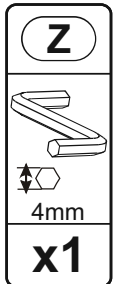
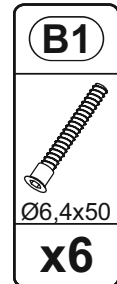
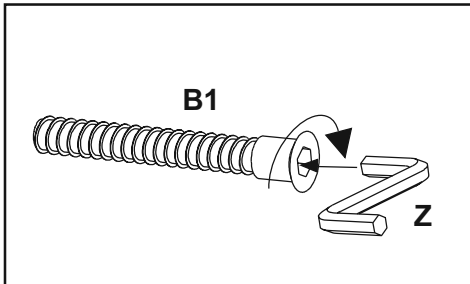

4

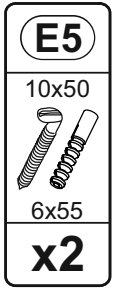
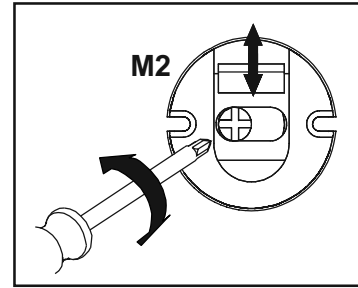
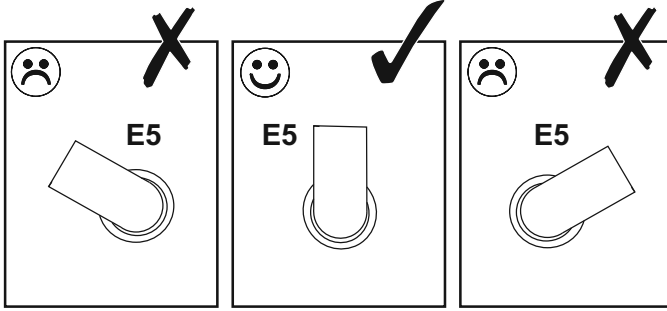

Ø10 mm

1020 mm

Ø10 mm

