

MAGGIORE
8241/2500/8300
8100/2500/8242

- | | | | |
|-----------|--|-----------|---|
| D | MONTAGEANLEITUNG
BEDIENUNGSANLEITUNG | GB | ASSEMBLY INSTRUCTIONS
INSTRUCTION MANUAL |
| NL | HANDLEIDING VOOR DE MONTAGE
GEBRUIKSAANWIJZING | PL | INSTRUKCJA MONTAŻU
INSTRUKCJA OBSŁUGI |
| TR | MONTAJ TALIMATI
KULLANIM KLAVUZU | RU | ИНСТРУКЦИЯ ПО МОНТАЖУ
ИНСТРУКЦИЯ ПО ЭКСПЛУАТАЦИИ |
| RO | INSTRUCȚIUNI DE INSTALARE
INSTRUCȚIUNI DE UTILIZARE | IT | ISTRUZIONI DI MONTAGGIO
MANUALE DI ISTRUZIONI |
| FR | NOTICE DE MONTAGE
MANUEL INSTRUCTIONS | SK | MONTÁŽNY NÁVOD
NÁVOD NA POUŽITIE |
| HU | KÖZGYŰLÉS UTASÍTÁSOK
KEZELÉSI UTASÍTÁS | CZ | MONTÁŽNÍ NÁVOD
NÁVOD K POUŽITÍ |
| SI | NAVODILA ZA MONTAŽO
NAVODILA ZA UPORABO | PT | INSTRUÇÕES DE MONTAGEM
MANUAL DO USUÁRIO |
| ES | INSTRUCCIONES DE MONTAJE
MANUAL DEL USUARIO | HR | UPUTE ZA MONTAŽU
UPUTE ZA UPOTREBU |

F/B

220701

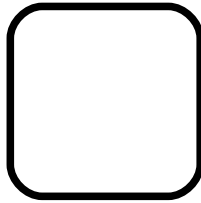
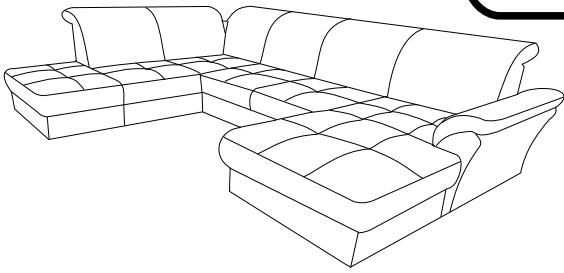
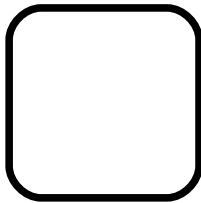

0019

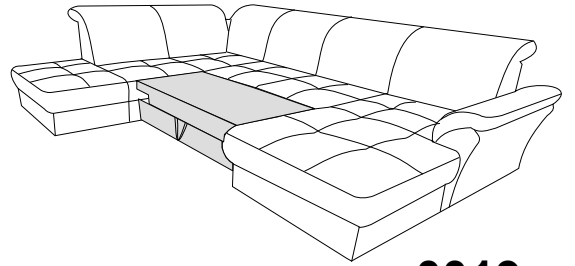

0019

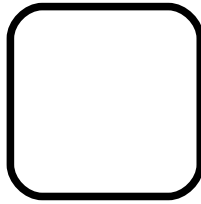
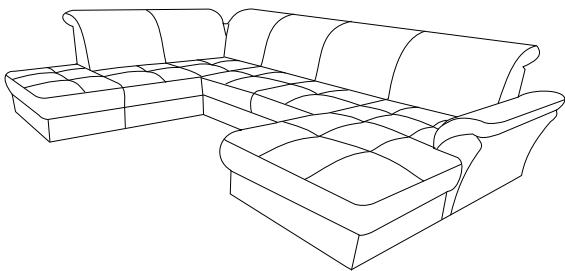
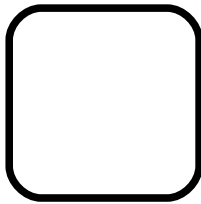

0088

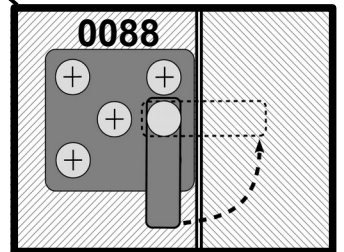
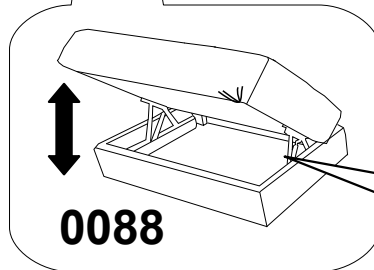
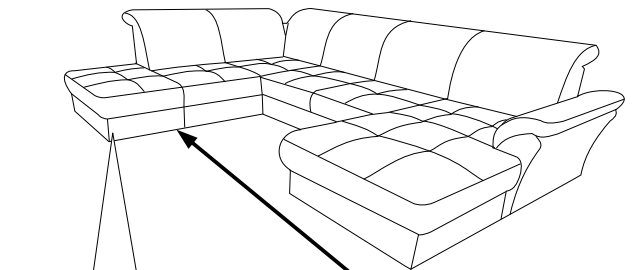
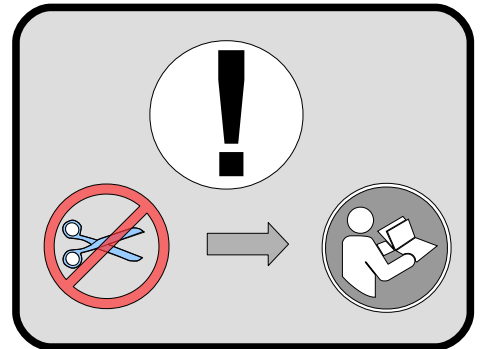

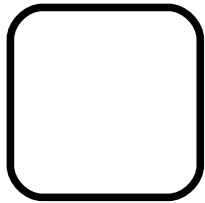
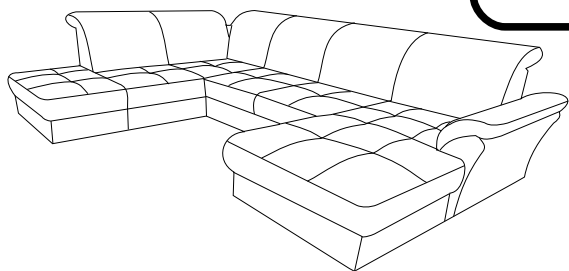
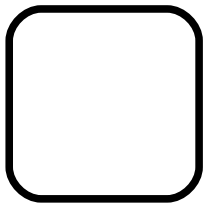

0089

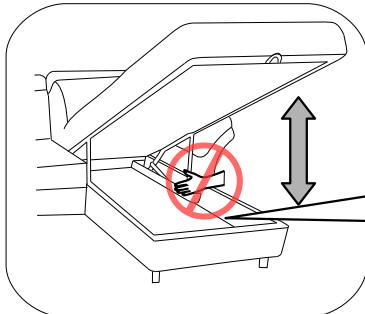
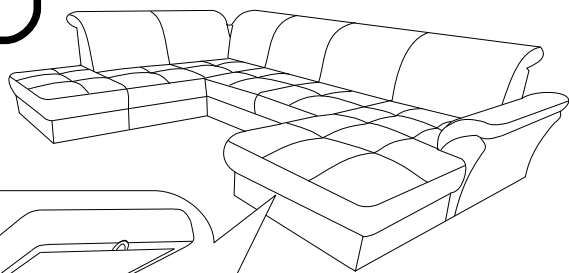

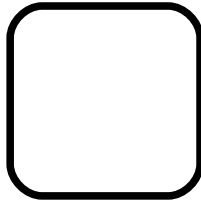
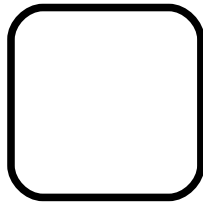

0064

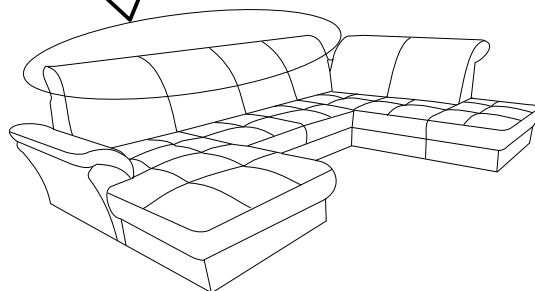
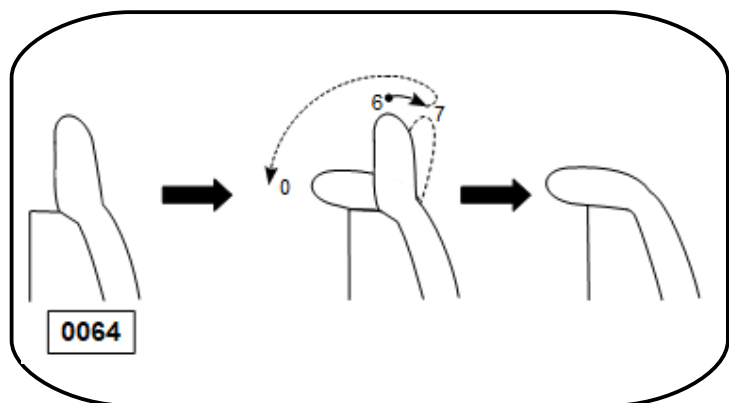
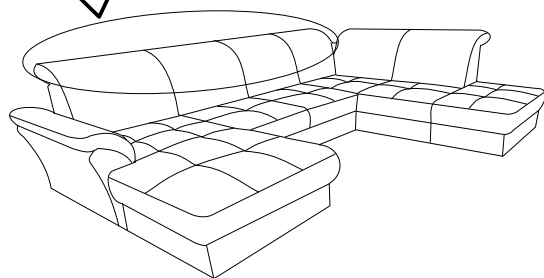
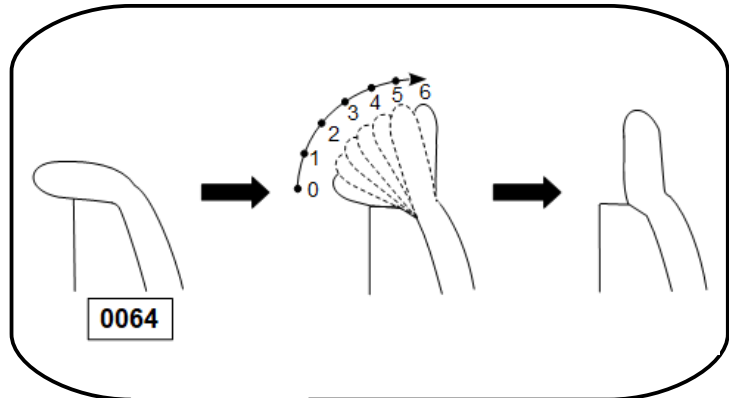
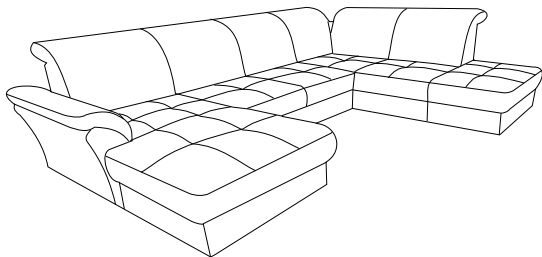

L

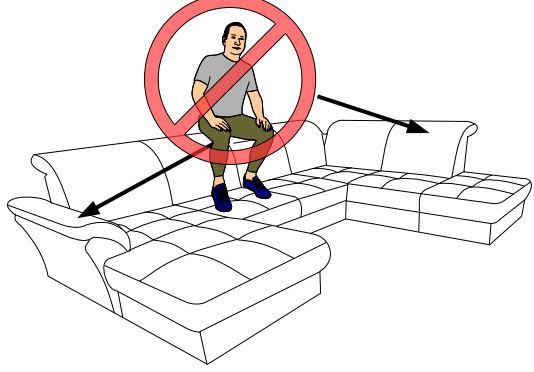

R

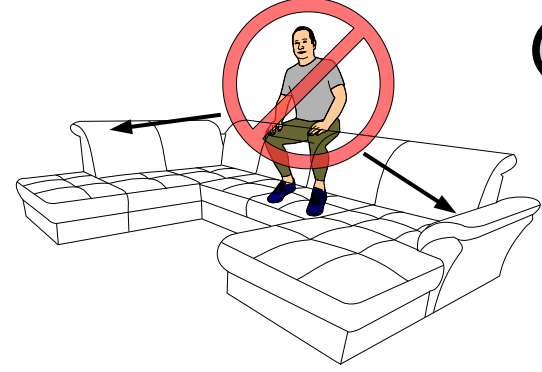



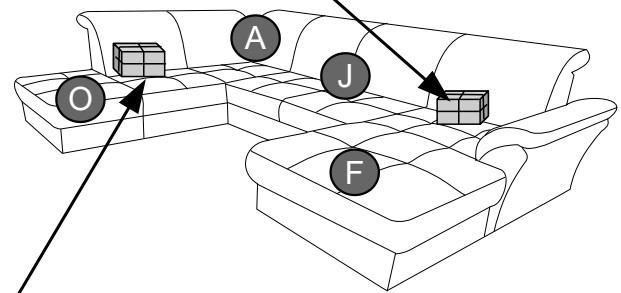
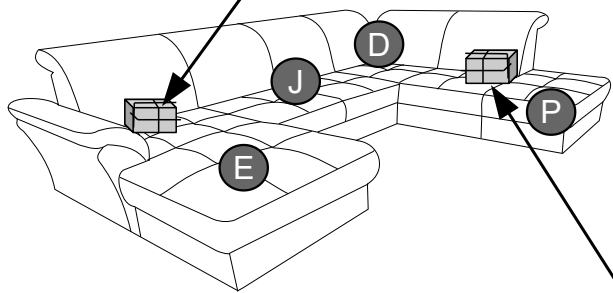

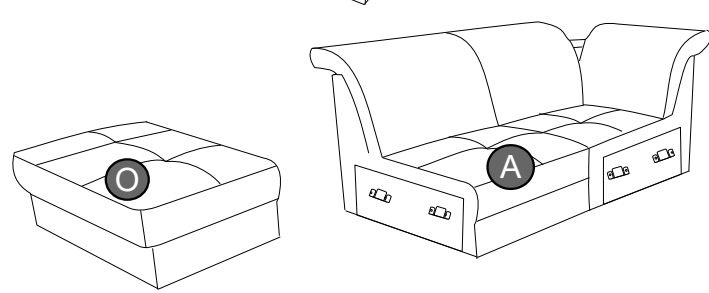
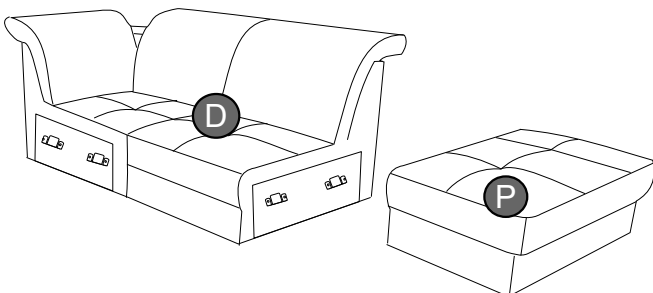
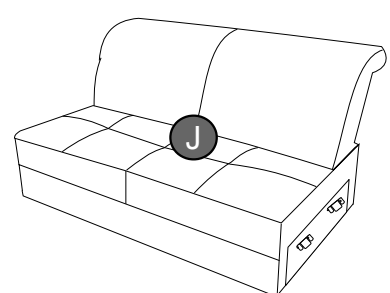
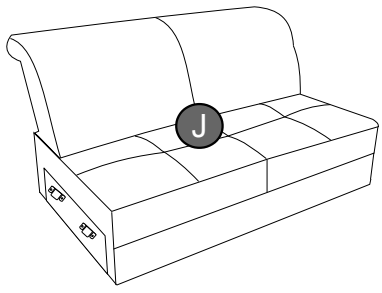
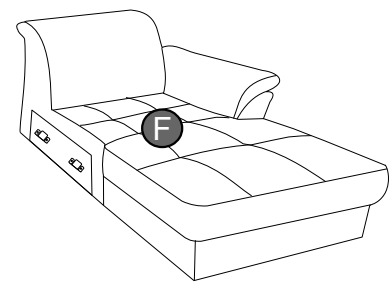
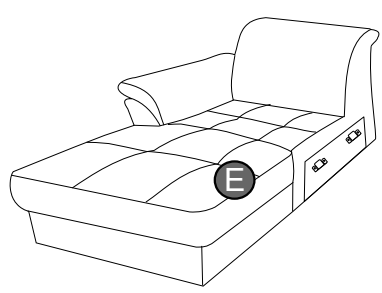

g H-120 X1	y H-120 X1	i L-5 X1	X H-120 X4	q M8*20 [mm] X4
--------------------------	--------------------------	------------------------	--------------------------	-------------------------------

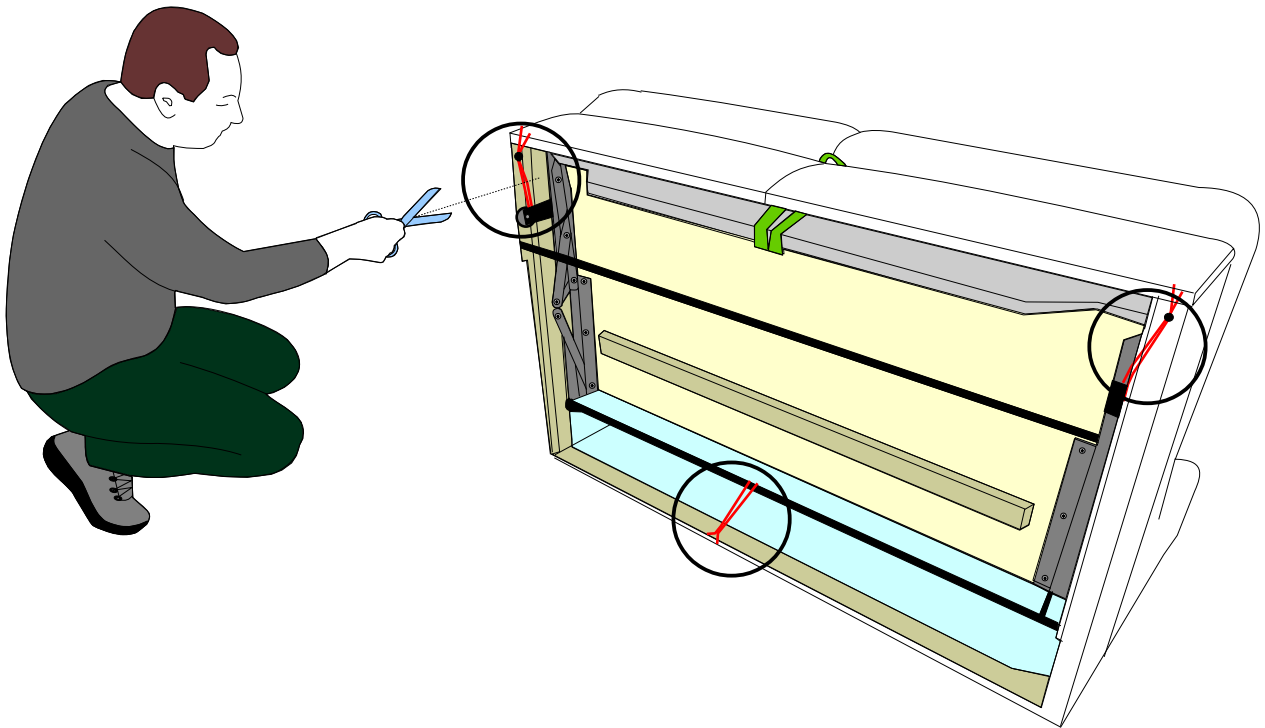
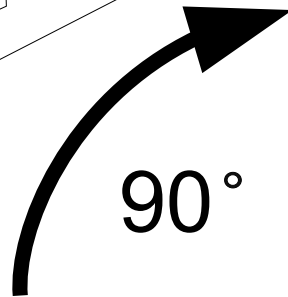
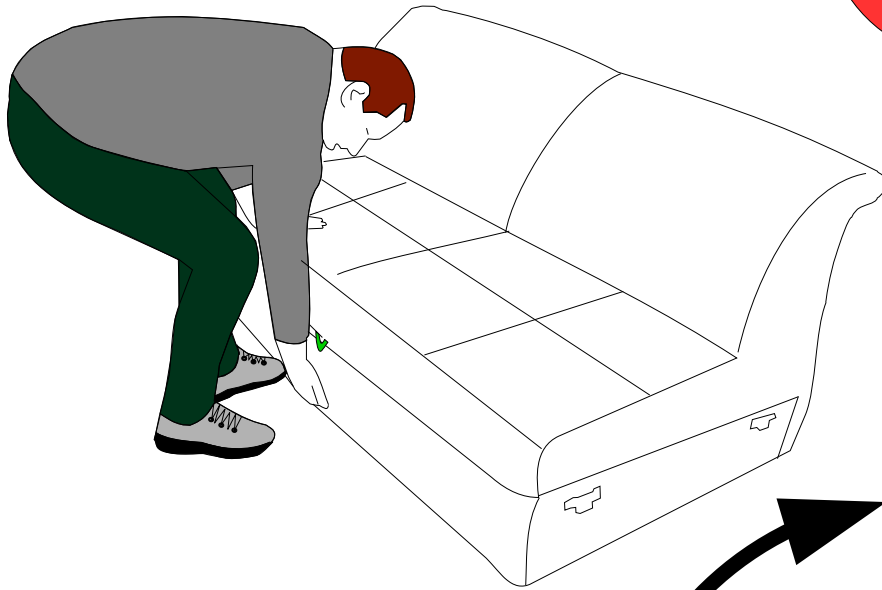

g H-120 X3	y H-120 X1	i L-5 X1	X H-120 X3	q M8*20 X3
--------------------------	--------------------------	------------------------	--------------------------	--------------------------





Z H-120  X4	y H-120  X2	i L-5  X1	X H-120  X₁ X7	q M8*20  X7
---	---	---	---	---

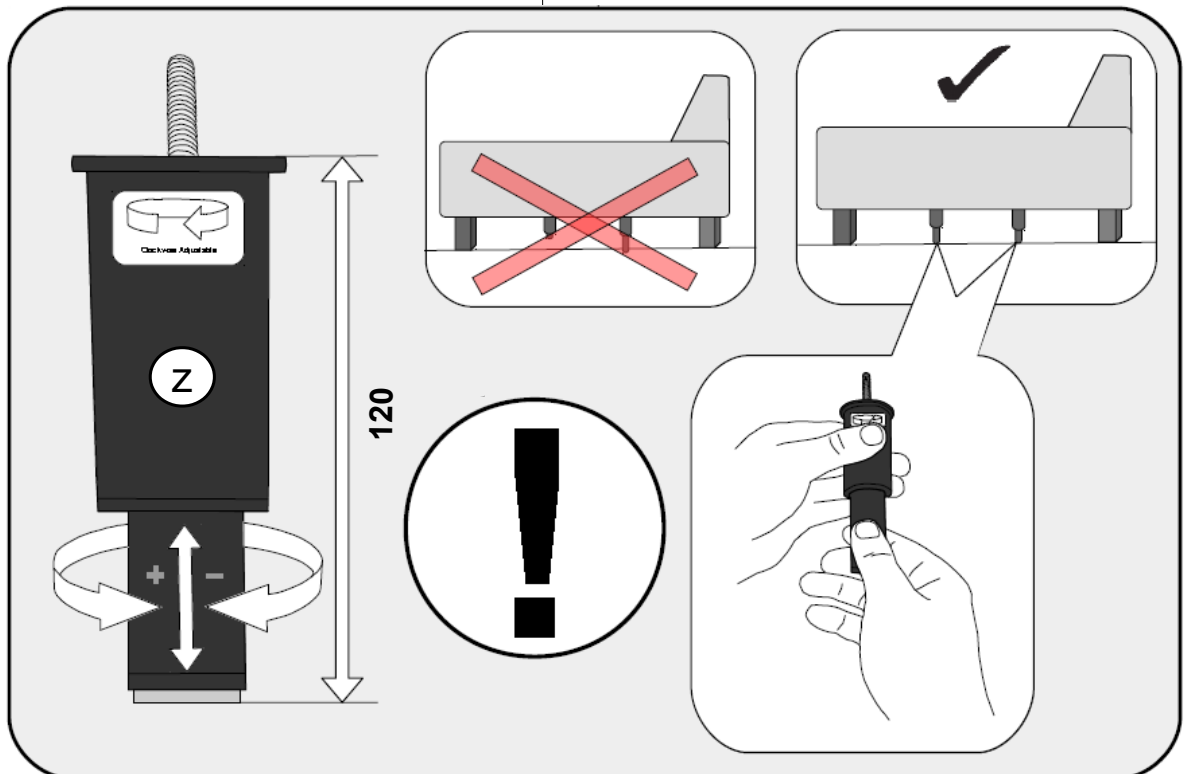
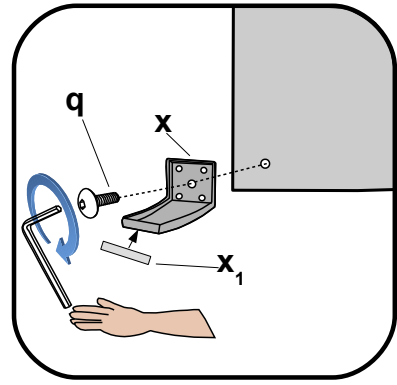
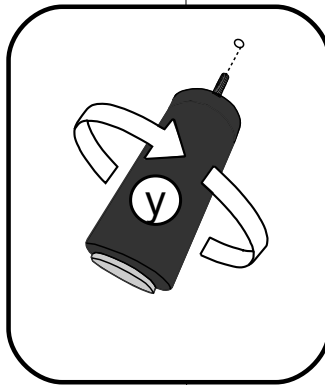
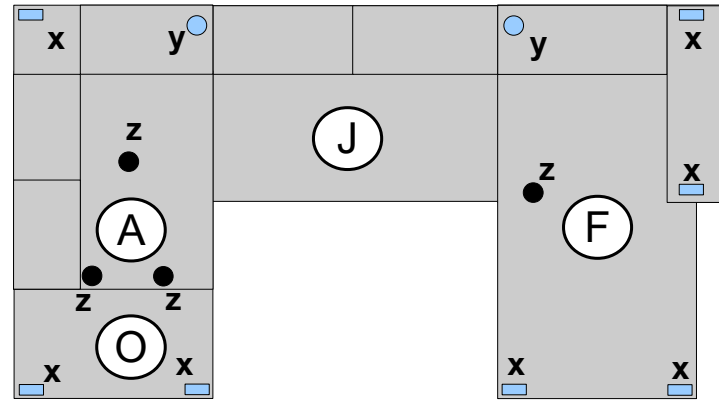
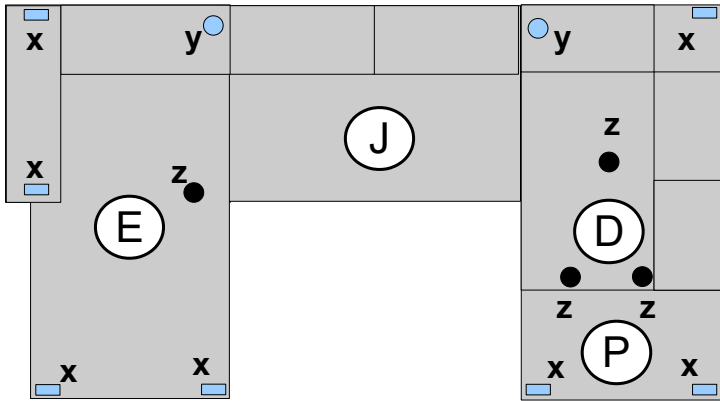
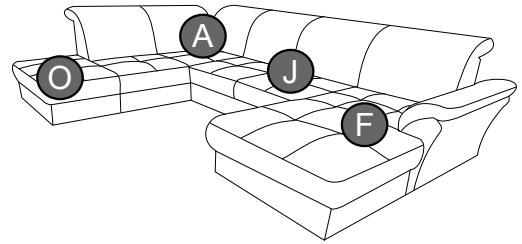
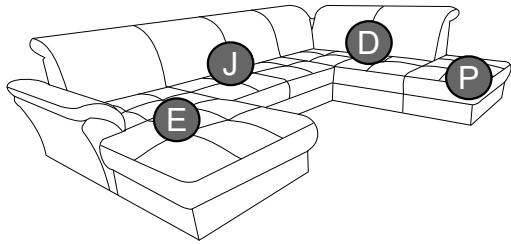

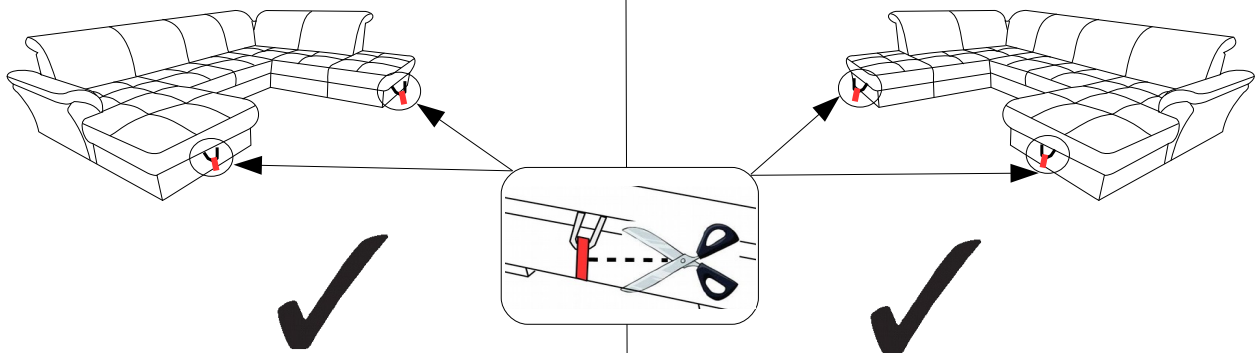
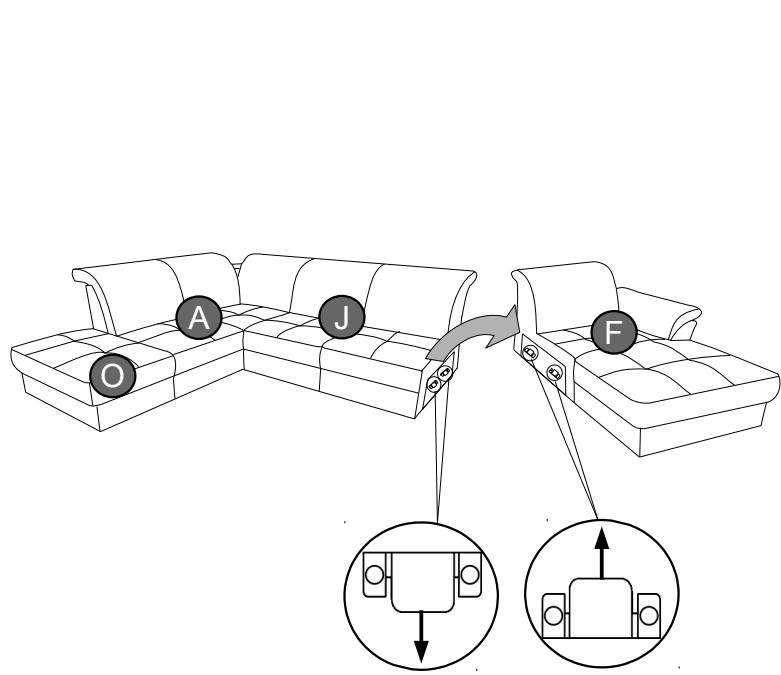
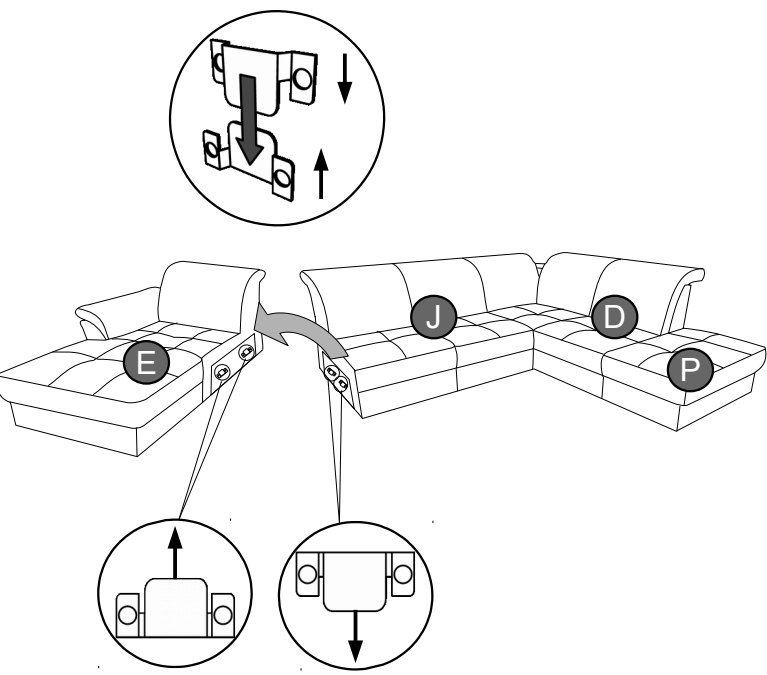
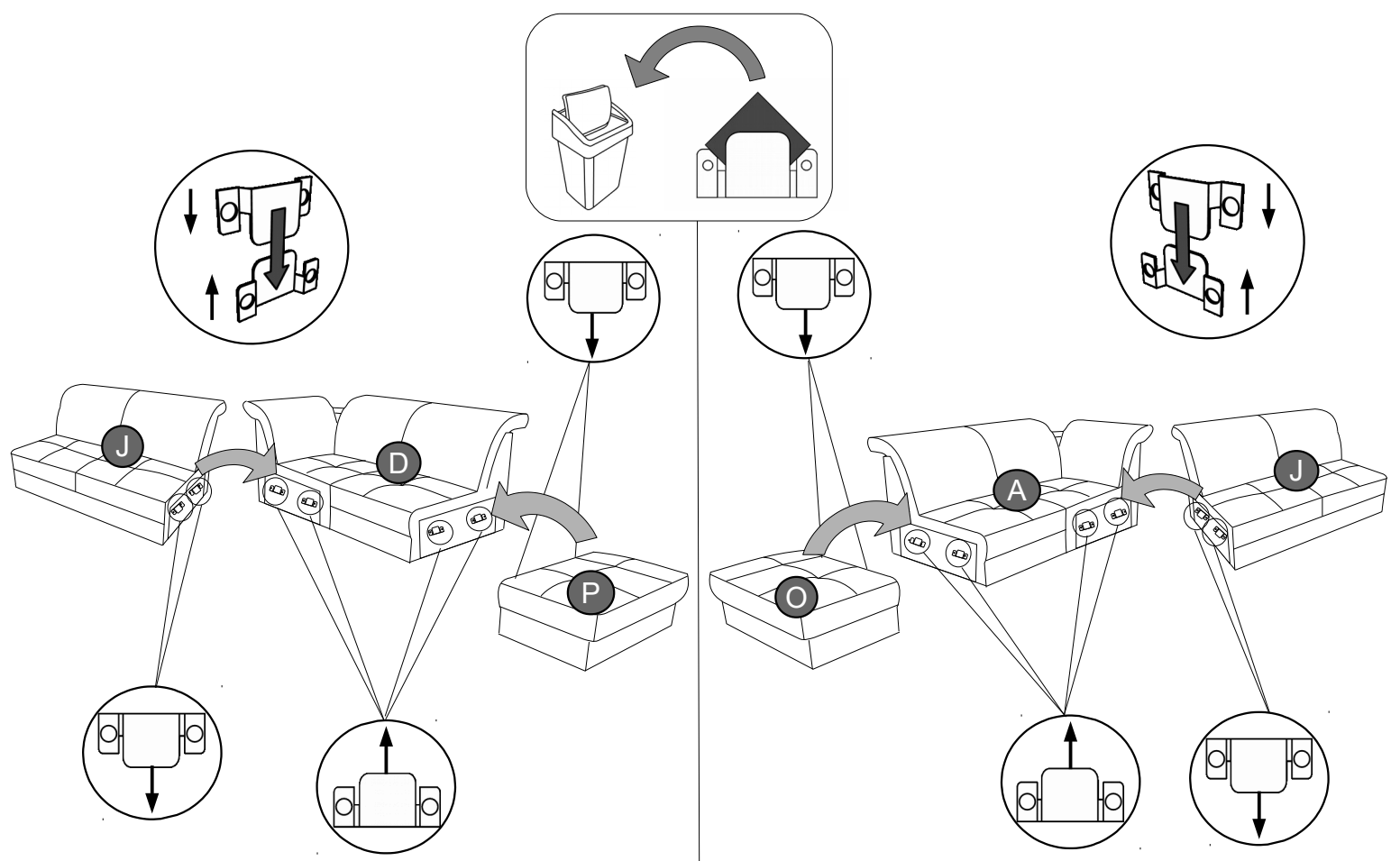

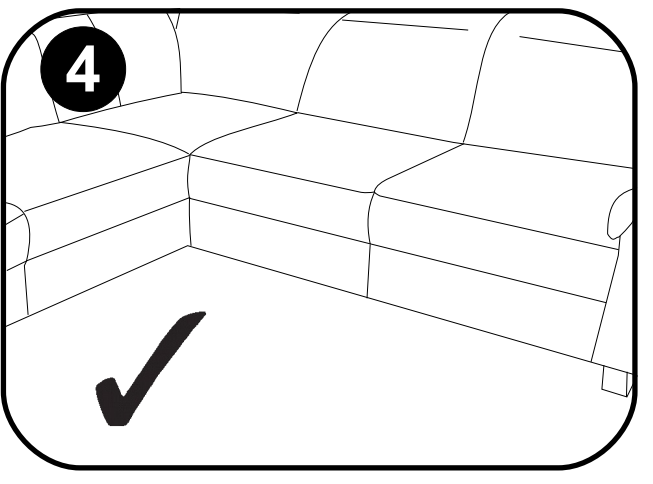
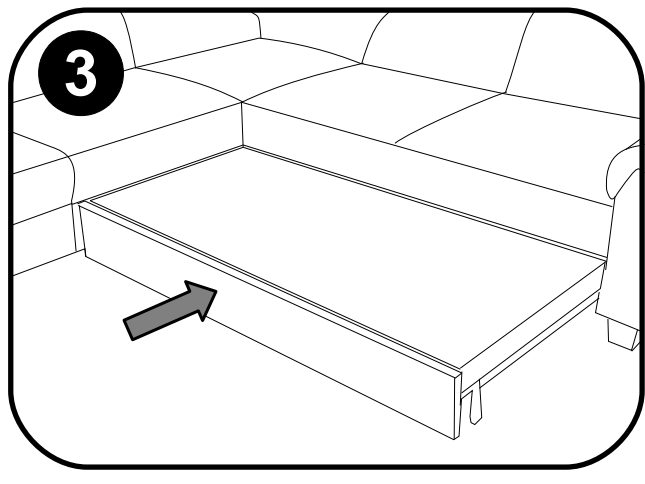
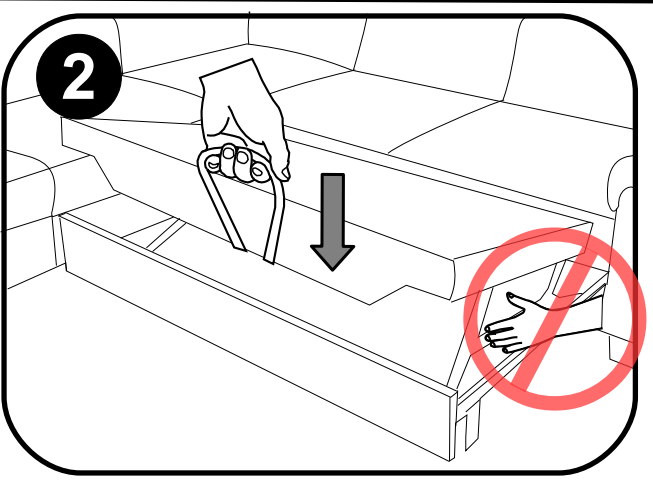
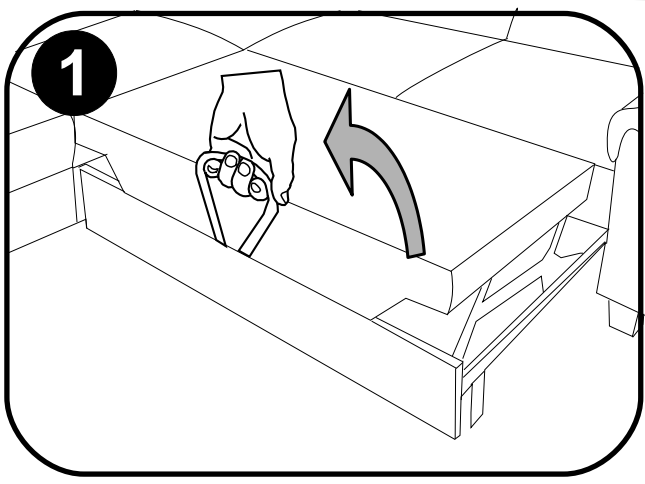
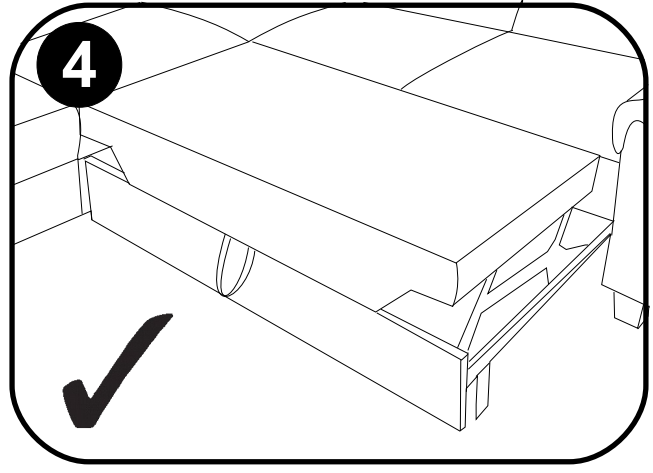
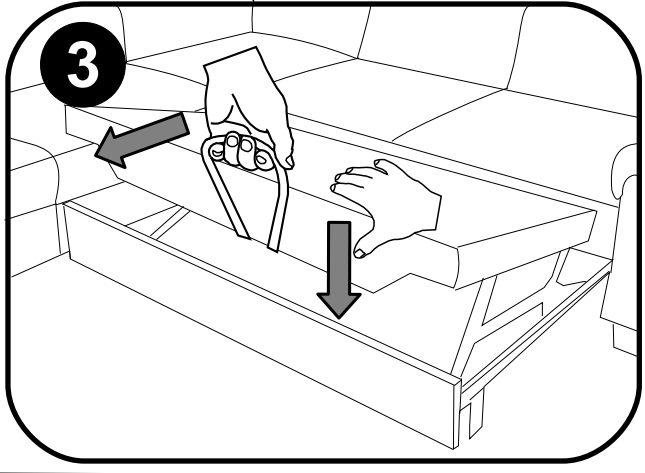
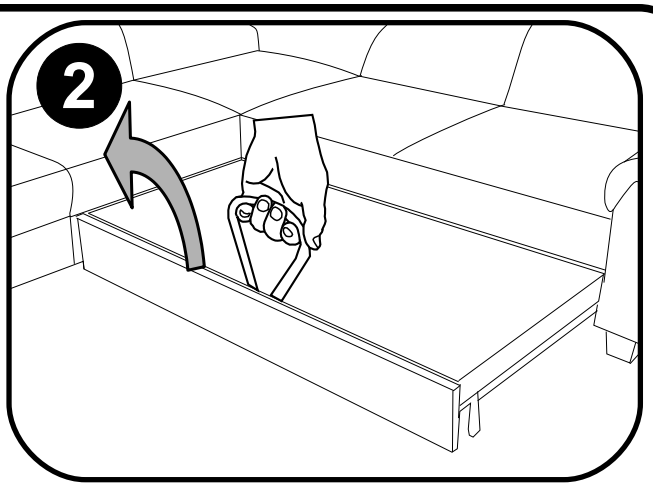
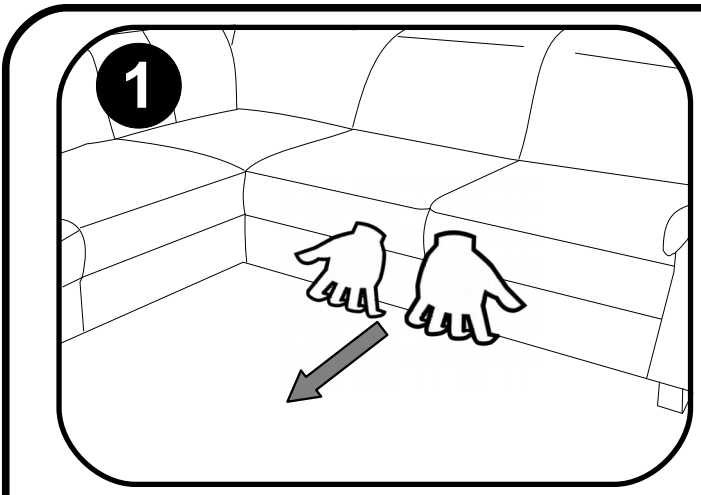
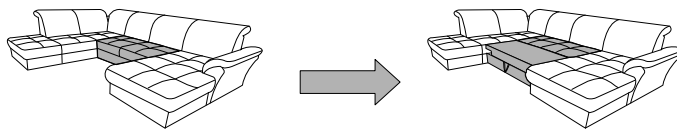

Name · Naam · Nazwa · İsim · Название · Nume · Nome · Názov · Názov ·
 Název · Neve

MAGGIORE



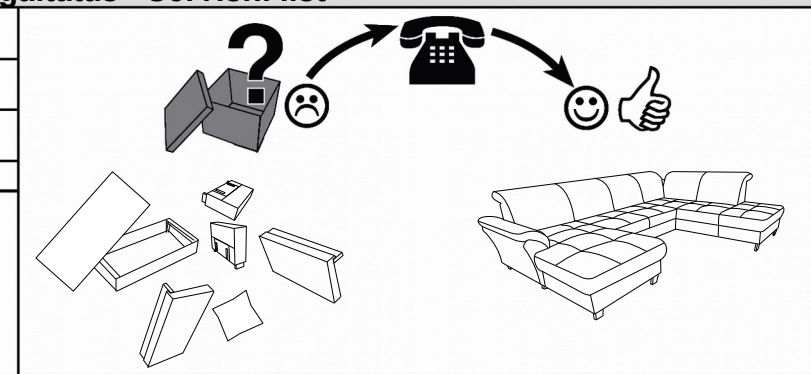
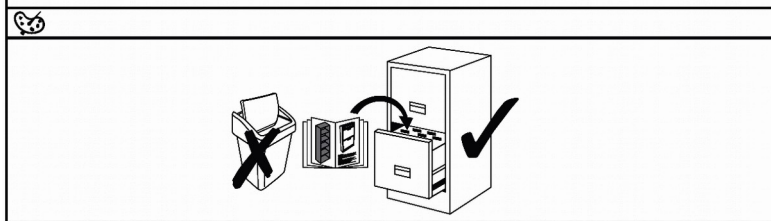

Typ · Type · Tip · Тип · Tipo · Típus

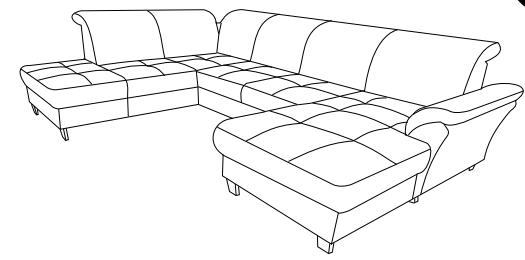
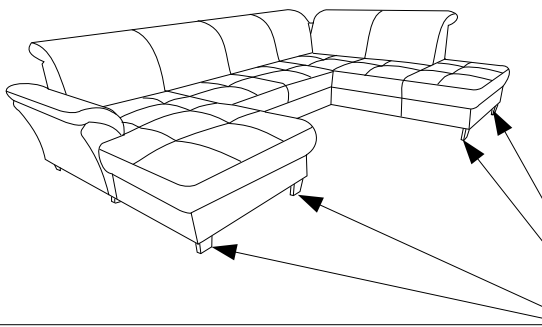

L

R



g H-120 	y H-120 	S H-120  S ₁	q M8*20 
--	--	---	--

