



PERIDUO-606



- ▶ User Manual
- ▶ Bedienungsanleitung
- ▶ manual de instrucciones
- ▶ Mode D'Emploi
- ▶ Manuale Utente
- ▶ 取扱説明書
- ▶ 产品说明书
- ▶ 使用手冊





Perixx's warranty obligations are limited to the terms set forth below. Perixx warrants this hardware product against defects in materials and workmanship for a period of two (2) years from the date of original invoice.

If you discover a defect, Perixx will, at its option, repair or replace the product at no charge to you, provided you return it during the warranty period with shipping charges pre-paid to Perixx. You must contact Perixx for a Return Merchandise Authorization number (RMA) prior to returning any product. For each product returned for warranty service, please include your name, shipping address (no P.O. Box), telephone number, a copy of the bill of sale as proof of purchase and make sure that the package is clearly marked with your RMA number.

THE WARRANTY AND REMEDIES SET FORTH ABOVE ARE EXCLUSIVE AND IN LIEU OF ALL OTHERS, WHETHER WRITTEN, ORAL, EXPRESS OR IMPLIED. PERIXX SPECIFICALLY DISCLAIMS ANY AND ALL IMPLIED WARRANTIES, INCLUDING AND WITHOUT LIMITATION, WARRANTIES OF MERCHANTABILITY AND FITNESS FOR A PARTICULAR PURPOSE. NO PERIXX DEALER, AGENT, OR EMPLOYEE IS AUTHORIZED TO MAKE ANY MODIFICATION, EXTENTION OR ADDITION TO THIS WARRANTY.

PERIXX IS NOT RESPONSIBLE FOR SPECIAL, INCIDENTAL OR CONSEQUENTIAL DAMAGES RESULTING FROM ANY BREACH OF WARRANTY, OR UNDER ANY LEGAL THEORY, INCLUDING BUT NOT LIMITED TO LOST PROFITS, DOWNTIME, GOODWILL, DAMAGE TO OR REPLACEMENT OF EQUIPMENT OR PROPERTY AND ANY COST OF RECOVERING, REPROGRAMMING OR REPLRODUCING ANY PROGRAM OR DATA STORED IN OR USED WITH PERIXX PRODUCTS. PERIXX'S MAXIMUM LIABILITY FOR ANY AND ALL DAMAGES ARISING OUT OF USE OF THE PRODUCT SHALL BE LIMITED TO THE AMOUNTS PAID BY PURCHASER FOR SUCH PRODUCT.



Caution

- The manufacturer and re-resellers are not responsible for any malfunctions, damage, or personal injury incurred by:
 - ▶ A misuse of the product
 - ▶ Any attempt to dismantle, change or modify the product in any manner
 - ▶ You are cautioned that changes or modifications not expressly approved by the party responsible for the compliance could void your authority to operate the equipment.
 - ▶ Mandatory repair charges are required for the following conditions, within the guarantee period:
 - ▶ Malfunction or damage is due to misuse or improper alteration or repair.
 - ▶ Malfunction or damage caused by the falling after the purchase.
 - ▶ Malfunction or damage is caused by a fire, salt, gas, earthquake, lighting, wind, water, or other natural calamities, or abnormal voltage.
 - ▶ Malfunction or damage is caused by other devices connected to the keyboard.
- All brand names, trademarks and logos are the properties of their respective owners.

Please Note: Long-term repetitive use of any keyboard could cause injury to user. Perixx recommends users avoid excessive use of this or any keyboard.



FCC Warning

This device complies with Part 15 of the FCC Rules. Operation is subject to the following two conditions:

(1) This device may not cause harmful interference, and (2) this device must accept any interference received, including interference that may cause undesired operation.

NOTE 1: This equipment has been tested and found to comply with the limits for a Class B digital device, pursuant to part 15 of the FCC Rules. These limits are designed to provide reasonable protection against harmful interference in a residential installation. This equipment generates uses and can radiate radio frequency energy and, if not installed and used in accordance with the instructions, may cause harmful interference to radio communications. However, there is no guarantee that interference will not occur in a particular installation. If this equipment does cause harmful interference to radio or television reception, which can be determined by turning the equipment off and on, the user is encouraged to try to correct the interference by one or more of the following measures:

- Reorient or relocate the receiving antenna.
- Increase the separation between the equipment and receiver.
- Connect the equipment into an outlet on a circuit different from that to which the receiver is connected.
- Consult the dealer or an experienced radio/TV technician for help.

NOTE 2: Any changes or modifications to this unit not expressly approved by the party responsible for compliance could void the user's authority to operate the equipment.

③ Keyboard Stand

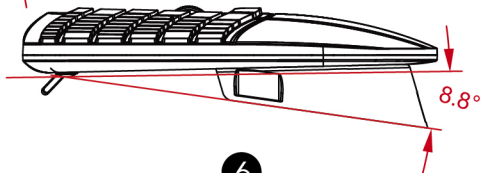
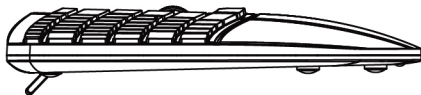
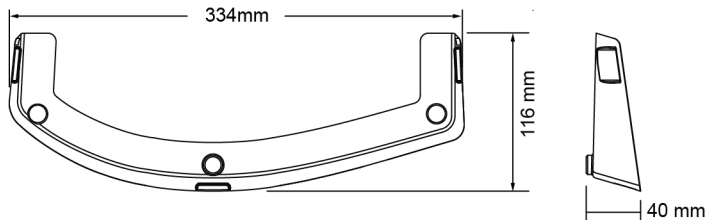



Product Illustration

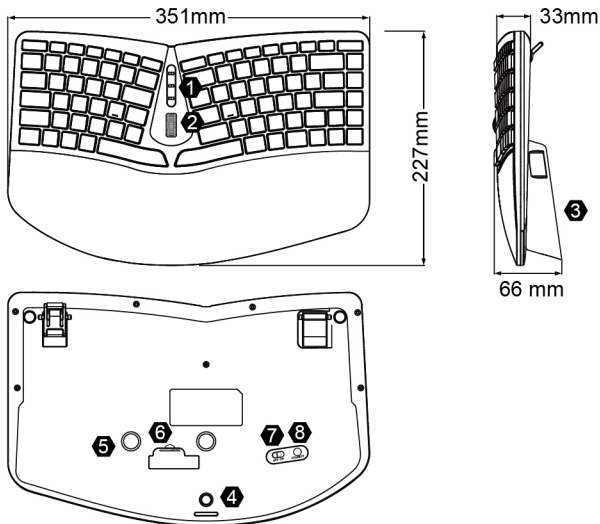

- ① LED Indicators (Num Lock, Caps Lock and Scroll Lock) ② Scroll Wheel/Middle Click
③ Keyboard Stand ④ Position 1: For Removable Magnet Foot & Keyboard Stand
⑤ Position 2: For Removable Magnet Foot ⑥ Battery ⑦ On/Off switch ⑧ Connect Button

⑤



Product Illustration

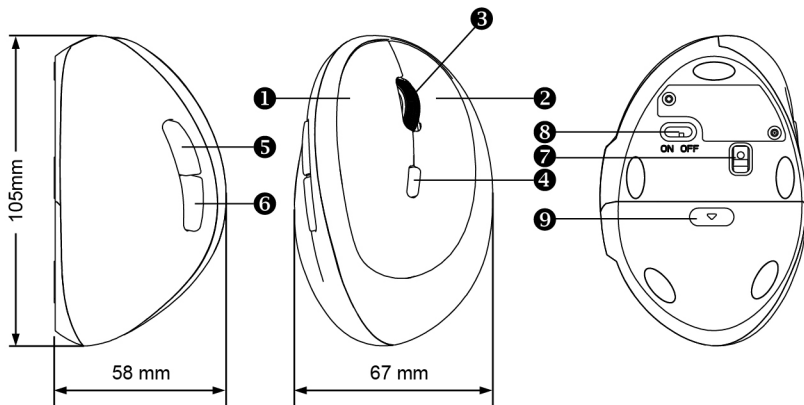

- ① Left Click Button
- ② Right Click Button
- ③ Scroll Wheel/Middle Click
- ④ DPI Switch
3DPI Levels: 800/1200/1600 DPI

- ⑤ Forward(Browser)
- ⑥ Backward(Browser)
- ⑦ Sensor
- ⑧ On/Off Switch
- ⑨ Battery Cover



Product Specification

Color	Black or White
Interface	Wireless 2.4G
Size	Keyboard: 351x227x66mm (with stand) Keyboard: 351x227x33mm (without stand) Mouse: 105*58*67mm
Weight	Keyboard: 640g Mouse: 102± 5g
Function key	17
Operation Temperature	0°C to 45°C
Storage Temperature	-15°C- 60°C
Electrical Rating	4.25 – 5.25 V
Operation voltage	≤ 20mA
Material	ABS
OS requirement	Windows XP and above



Installation Process

Step 1

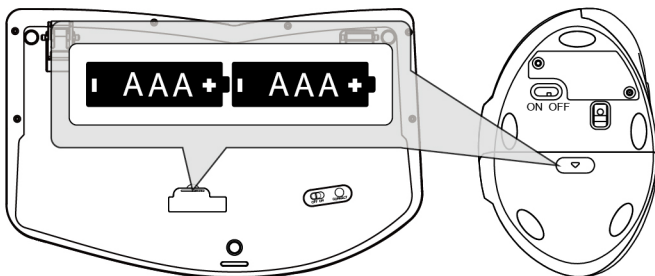

Step 2

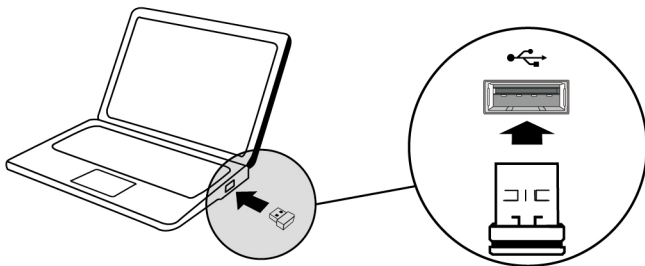

Step 3

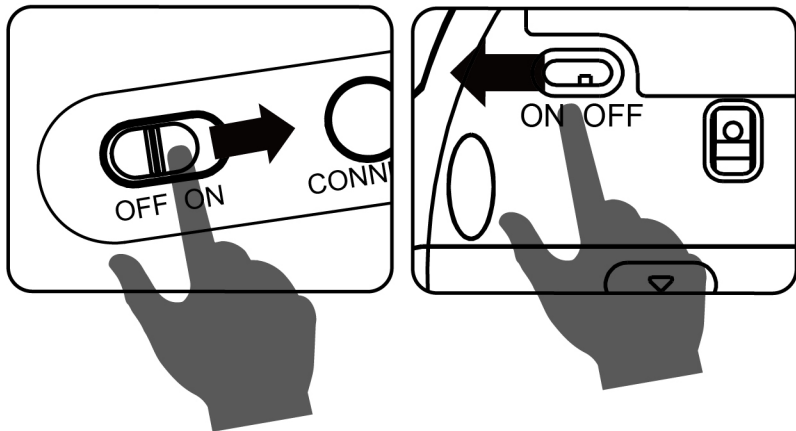



Power Saving Mode & Battery Consumption

Power Saving mode helps to consume minimum power (when kept on) by turning off signal connection when the mouse is in Idle Mode and increases the battery life.

Keyboard

	Active Mode	Static Mode	Sleeping Mode (LED off)
Stop Working Time	-	2 Sec	After 5 Minutes
Current Consumption	<3.5mA	<0.15mA	<0.1mA

When the mouse is in power saving mode, click on any mouse button to reconnect.

2pcs of brand-new AAA battery (1100mAh) provides up to 80 days of use when you use about two hours a day

Low Voltage Indicator:

Indicator (Num Lock) will flash 15 times

Mouse

	Working Mode	Static Mode	Power Saving Mode	Power Saving Mode II (LED flash slowly)	Deeply Sleeping Mode (LED off)
Stop Working Time	-	2 Sec	10 Sec	6 Minutes	After 8 Minutes
Current Consumption	<10mA	<5mA	<1.8mA	<0.5mA	<0.3mA



When the mouse is in power saving mode, click on any mouse button to reconnect
2pcs of brand-new AAA battery (1100mAh) provides up to 80 days of use when you
use about two hours a day.

Caution

Please do not use rechargeable AAA battery with the product. The voltage spec of
rechargeable battery (1.2V) is lower than the normal alkaline battery (1.5V), and your
device may run out of power very soon if you use the rechargeable battery. With the
optimal performance of the product, we recommend you to use the alkaline battery
on the device.



Table of Content

ENGLISH	-----	14
DEUTSCH	-----	17
ESPAÑOL	-----	20
FRANÇAIS	-----	23
ITALIANO	-----	26
日本語	-----	29
簡中	-----	32
繁中	-----	35

Caution

- The manufacturer and re-resellers are not responsible for any technical malfunctions, damage, or personal injury incurred by:
 - ▶ Any attempt to dismantle, change or modify the product in any manner
 - ▶ Malfunction or damage due to misuse or improper alteration or repair.
 - ▶ Malfunction or damage caused by external influence such as falling
 - ▶ Malfunction or damage is caused by a fire, salt, gas, earthquake, lightning, wind, water, or other natural calamities, or abnormal voltage.
 - ▶ Malfunction or damage is caused by other devices connected to the products.
 - ▶ Malfunction or damage is caused by high temperature, humid, greasy, dusty and hazardous environment.
- You are cautioned that changes or modifications not expressly approved by Perixx Computer GmbH could void your authority to operate the equipment.
- All brand names, trademarks and logos are the properties of their respective owners.

Please Note: Long-term repetitive use of any keyboard and mouse could cause injury to user. Perixx recommends users to avoid excessive use of this or any keyboard and mouse.



English(US/UK)

Thank you for purchasing a Perixx product. PEIRDUO-606 is a user friendly full size keyboard. It is an ideal solution for the office or home working space. It is easy to install and use with plug and play feature. There is no need to install any driver or software. You can use it with various applications like All-in-one PC, Notebook, and your Desktop PC.

System Requirements

- Operating System: Microsoft Windows XP/7/8/10
- 1 x Free USB Port

Installation Process

The following steps initiate a connection process of the PERIDUO-606 to your PC.

1. Turn ON the PC
2. Insert Batteries
3. Plug the USB Receiver into a free USB Port
4. The device will be automatically detected by the PC, and it should be ready to work
5. If the device is still not working, please repeat the process from step 1
5. If the device is still not working, please repeat the process from step 1
6. If the device is still not working, try to reboot the connection by unplugging your receiver from port and plug it back in again. Then, press and hold the connect button for 5 seconds.

Hot Keys

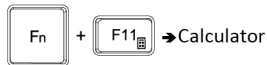
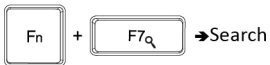
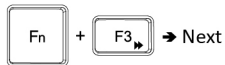
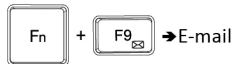

Bitte beachten Sie:

- Der Hersteller sowie die Wiederverkäufer sind nicht verantwortlich für technische Defekte, Schäden oder mögliche Verletzungen verursacht durch:
 - ▶ Versuche, den Artikel zu demontieren oder in jeglicher Form zu verändern
 - ▶ Zweckentfremdung oder eigene Reparaturen
 - ▶ Fremdeinwirkung wie z.B. Sturz oder Schlag
 - ▶ Feuer, Gas, Erdbeben, Blitz, Wind, Wasser, Überspannung oder jede andere Form von äußerer Gewalt
 - ▶ Andere mit der Tastatur verbundene Geräte
 - ▶ Zu hohe Temperaturen oder eine feuchte, staubige oder gefährliche Umgebung
- Der Benutzer wird darauf hingewiesen, dass Änderungen oder Modifizierungen an der Gerätschaft, die von Perixx Computer GmbH nicht ausdrücklich genehmigt sind, die Erlaubnis des Benutzers zur Inbetriebnahme des Gerätes außer Kraft setzen könnte.
- Alle Markennamen, Warenzeichen und Logos sind Eigentum von Perixx.

Die übermäßige Langzeit-Verwendung jeder Tastatur und Maus kann zu Verletzungen führen. Perixx empfiehlt Benutzern den übermäßigen Gebrauch von jeglicher Tastatur und Maus zu vermeiden.

Vielen Dank für Ihren Kauf dieses Perixx Produkts. Das PEIRDUO-606 zeichnet sich durch seine praktische Größe und seinem ausgezeichnetem Design aus, welches sich in jede Arbeitsumgebung einpasst. Es bietet somit die ideale Lösung für Büro-, Heim- und Gaming-Bedürfnisse. Durch die Plug & Play Funktion ist es leicht zu verwenden, einfach anschließen, es benötigt keine weitere Treiber- oder Softwareinstallation.



System Voraussetzungen:

- Betriebssysteme: Microsoft Windows XP/7/8/10
- 1 x freier USB Port

Tastatur Installation

1. Schalten Sie Ihren PC ein.
2. Legen Sie die Batterien ein.
3. Stecken sie den USB Receiver in einen freien USB-Anschluss.
4. Das Gerät sollte nun automatisch vom PC erkannt werden und funktionsbereit sein.
Sollte das Gerät nicht funktionieren, wiederholen Sie bitte die Installation mit Schritt 1
5. Wenn Ihr Gerät immer noch nicht funktioniert, schließen Sie den Empfänger erneut an und drücken Sie die "Connect" -Taste für 5 Sekunden.

Hot Keys

 +  → Vorheriges Lied

 +  → - Volume



 +  → E-Mail öffnen

 +  → Play / Pause

 +  → + Volume



 +  → Startseite

 +  → Nächstes Lied

 +  → Suche

 +  → Rechner öffnen

 +  → Stumm

 +  → Favoriten

Caution

Tenga en cuenta:

- El fabricante y los distribuidores no son responsables de los defectos técnicos, daño o perjuicio causado por:
 - intentos de desmantelar o cambiar el producto en cualquier forma
 - apropiación indebida o propias reparaciones
 - influencias externas como caída o un golpe
 - fuego, gas, terremotos, rayos, viento, agua o cualquier otra forma de fuerza externa
 - Otros dispositivos conectados al teclado
 - temperaturas altas o un ambiente húmedo, polvoriento o peligroso
- Se advierte al usuario que los cambios o modificaciones del producto que no estén aprobados expresamente por Perixx Computer GmbH, permiten anular el uso del dispositivo al usuario.
- Todos los nombres de marcas, marcas comerciales y logotipos son propiedad de Perixx.

El uso excesivo a largo plazo de cualquier teclado y el ratón puede causar lesiones. Perixx recomienda evitar el uso excesivo de cualquier teclado y ratón.



ESPAÑOL (ES)

Gracias por la compra de un producto Perixx. Con un excelente rendimiento y funcionamiento, el PEIRDUO-606 cumple con las exigencias de una amplia variedad de aplicaciones. Es una solución ideal en el hogar o en la oficina. No es necesario instalar ningún software o driver antes de utilizar el teclado.

Requisitos del sistema

- Sistema operativo: Microsoft Windows XP/7/8/10
- 1 puerto USB libre

Instalación

1. Encienda el ordenador
2. Coloque pilas
3. Enchufe el receptor USB a un puerto USB libre
4. El ordenador detectará automáticamente el dispositivo, que estará en condiciones de funcionar
5. Si el dispositivo todavía no funciona, repita el proceso nuevamente a partir del paso 1
Si el dispositivo sigue sin funcionar, sírvase volver a encender el receptor. Enseguida presionar el botón “Connect” durante 5 segundos.

Teclas de acceso rápido

Fn + **F1** → Canción anterior

Fn + **F5** → - Volumen

Fn + **F9** → Abrir correo electrónico

Fn + **F2** → Reproducir / Pausa

Fn + **F6** → + Volumen

Fn + **F10** → Abrir página principal

Fn + **F3** → Canción siguiente

Fn + **F7** → Búsqueda

Fn + **F11** → Calculadora

Fn + **F4** → Silencio

Fn + **F8** → Favoritos

Avertissement

- Le fabricant et les revendeurs ne sont pas responsables des défaillances techniques ou des dommages occasionnés par:
 - ▶ Toute tentative de démonter, changer ou modifier le produit quelle qu'elle soit la manière
 - ▶ Dysfonctionnement ou dommages à cause d'une mauvaise utilisation, d'une modification incorrecte ou d'une réparation.
 - ▶ Dysfonctionnement ou dommages causés par une chute après l'achat.
 - ▶ Dysfonctionnement ou dommages causés par un incendie, le sel, le gaz, un tremblement de terre, la foudre, le vent, l'eau, ou d'autres désastres naturels, ou d'une tension anormale.
 - ▶ Dysfonctionnement ou les dommages causés par d'autres appareils connectés au clavier.
 - ▶ Dysfonctionnement ou dommage causé par une température élevée, environnement humide, gras, poussiéreux et dangereux
- Vous êtes averti sur les changements ou des modifications qui ne sont pas expressément approuvés par le responsable tiers pour la conformité pourraient annuler votre autorité quant à utiliser cet appareil.
- Tous les noms de marque, marques et logos sont de la propriété de Perixx.



FRANÇAIS (FR)

PEIRDUO-606 permet de créer un environnement de travail flexible, pratique et sans fil grâce à sa conception ergonomique. PEIRDUO-606 offre une pénétration haute fréquence fiable de 2,4 GHz, de faibles interférences et une transmission omnidirectionnelle des signaux avec une distance de réception de 10 mètres

Configuration requise

- Systèmes d'exploitation : Microsoft Windows XP/7/8/10
- 1 x Port USB libre























Processus d'installation

Les étapes ci-dessous indiquent le processus de connexion de PERIDUO-606 à votre PC.

1. Allumer le PC
2. Mettre en place piles
3. Brancher le récepteur USB dans un port USB libre.
4. Le dispositif sera automatique détecté par le PC et il doit être prêt à fonctionner.
5. Si le dispositif ne fonctionne toujours pas, veuillez recommencer la procédure à partir de l'étape 1.
6. Si le dispositif ne fonctionne toujours pas, veuillez rebrancher le récepteur. Ensuite appuyer sur le bouton « Connect » pendant 5 secondes.

FRANÇAIS (FR)

Hotkeys

 +  → Piste précédente	 +  → Volume –	 +  → E-mail
 +  → Lecture / Pause	 +  → Volume +	 +  → Accueil
 +  → Piste suivante	 +  → Recherche	 +  → Calculatrice
 +  → Muet	 +  → Favoris	

Attenzione

- Il produttore e i rivenditori non sono responsabili per eventuali malfunzionamenti tecnici, danni o lesioni personali causati da:
 - ▶Qualsiasi tentativo di smantellare, cambiare o modificare il prodotto in qualsiasi modo
 - ▶Malfunzionamenti o danni dovuti ad uso, alterazione o riparazione impropri.
 - ▶Malfunzionamenti o danni causati da fattori esterni come la caduta
 - ▶Malfunzionamenti o danni causati da incendi, sale, gas, terremoti, fulmini, vento, acqua, o altre calamità naturali, ovvero da voltaggio anomalo.
 - ▶Malfunzionamenti o danni causati da altri dispositivi connessi al prodotto.
 - ▶Malfunzionamenti o danni causati da alte temperature ovvero da ambiente umido, grasso, polveroso o pericoloso.
- Si avvisa che alterazioni o modifiche non espressamente approvate da Perixx Computer GmbH potrebbero annullare il vostro permesso di utilizzare l'apparecchiatura.
- Tutte le etichette, i marchi e loghi sono di proprietà dei rispettivi titolari.

Nota: A lungo termine l'uso ripetitivo di qualsiasi tastiera e mouse potrebbe causare lesioni all'utente. Perixx consiglia agli utenti di evitare l'uso eccessivo di questa o di qualsiasi altra tastiera o mouse.



ITALIANO (IT)

PEIRDUO-606 permette di creare un ambiente di lavoro flessibile, comodo e wireless grazie al suo design ergonomico. PEIRDUO-606 offre un'affidabile penetrazione ad alta frequenza 2,4 GHz, un basso livello di interferenza e una trasmissione onnidirezionale del segnale con una distanza di ricezione di 10 metri.

Requisiti di sistema

- Sistema operativo: Microsoft Windows XP/7/8/10
- 1 porta USB libera

Procedura di installazione

Le seguenti istruzioni permettono di avviare la procedura di connessione di PERIDUO-605 al proprio PC.

1. Accendere il PC
2. Inserire batterie
3. Inserire la ricevente USB in una porta USB libera
4. La periferica verrà rilevata automaticamente dal PC e normalmente sarà pronta all'uso
5. Qualora la periferica non fosse ancora operativa, ripetere la procedura dal punto 1
6. Se il dispositivo continua a non funzionare correttamente, ricollegare il ricevitore. Quindi premere il pulsante "Connetti" per 5 secondi.

Hot Keys

Fn + F1  → Traccia precedente

Fn + F5  → Volume basso

Fn + F9  → E-mail

Fn + F2  → Play / Pausa

Fn + F6  → Volume aumento

Fn + F10  → Aprire homepage

Fn + F3  → Traccia successiva

Fn + F7  → ricerca

Fn + F11  → Calcolatrice

Fn + F4  → Muto

Fn + F8  → Il mio preferito

保証規定のご注意

- 保証期間中でも次の場合は、弊社若しくは再販売業者が保証対象外と判断させていただきます。
 - ▶弊社および弊社が指定する機関以外の第三者ならびにお客様による改造、分解、修理により故障した場合。
 - ▶乱用、誤用などによる故障・損傷が生じた場合。
 - ▶お取扱上の不注意(落下、衝撃、水掛り、砂・泥の付着、機器内部への水・砂・薬品の入り込みなど)により故障した場合。
 - ▶地震、火災、落雷、風水害、その他の天変地異、公害、異常電圧などの外的要因により故障した場合。
 - ▶弊社が定める機器以外に接続、または組み込んで使用し、故障または破損した場合。
 - ▶通常一般家庭内で想定される使用環境の範囲を超える温度、湿度、振動等、若しくは手入れの不備(カビ発生、チリ・ホコリ等)により故障した場合。
 - ▶その他、無償修理または交換が認められない事由が発見された 場合。
- 利用規約を遵守いただけない場合(不当な改造や修理等)には、本製品の使用を制限させていただきます。何卒ご了承ください。
- 本書に記載のブランド名、ロゴマーク商標権はPerixxが所有しています。

ご注意:マウスやキーボードなどを長時間操作すると、手や腕や首、肩などに深刻な障害を引き起こす恐れがあります。長時間連続のご使用をお控えください。

日本語 (JA)

Perixx製品をご購入いただきありがとうございます。PEIRDUO-606は、その品質、デザインと競争力のある価格で、快適な性能と優れたパフォーマンスを生み出すことができ、使い勝手の良い製品です。オフィス、家庭のニーズに最適なソリューションです。プラグアンドプレイがサポートされており、ドライバやソフトウェアをインストールする必要はありません。デスクトップPC、ノートパソコン、All-in-Oneなど様々な応用に使えます。

対応OS・機種









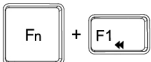

- 対応OS: Windows XP/7/8/10
- USBポート搭載PC

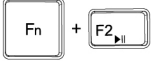
インストール手順

以下はPERIDUO-606をお手持ちのパソコンにインストールする際の手順です。

1. PCの電源を入れます。
2. 電池を挿入します。
3. USBレシーバーを接続します。
4. 機器がPCに自動的に認識され使用可能になります。
5. もし使用できない場合は、もう一度手順の1から繰り返してください。
6. 万が一キーボードが動かない場合はレシーバーを一度とり外し、もう一度入れなおしてから接続"Connect"ボタンを再度5秒間押してください。

日本語 (JA)

 → 前の曲	 → 音量を下げる	 → 電子メール
 → 再生 / 一時停止	 → 音量を上げ	 → ブラウザの ホームページ
 → 次の曲	 → 検索	 → 電卓
 → ミュート	 → お気に入り	

注意

- 制造商和经销商不对以下行为所导致的任何技术故障损失或人身伤害承担责任
 - 以任何方式企图拆除，更改或修改产品引起的故障或损坏
 - 由于误用或不当更改，修理故障引起的故障或损坏
 - 由于购买后摔落产品引起的故障或损坏
 - 由于火，盐，气体，地震，曝晒，风，水，或其他自然灾害，或异常电压引起的故障或损坏
 - 由于产品连接到其它设备引起的故障或损坏。
 - 由于高温，潮湿，油腻，多尘和危险的环境引起的故障或损坏
- 请注意，若由未经合规责任方明确批准的变更或修改，可能使用户失去对设备的操作权限
- 所有的品牌名称，商标和标志是其各自所有者的财产

请注意：长期反复使用键盘和鼠标可能对用户造成伤害。Perixx建议用户避免过度使用任何键盘和鼠标。



简体中文(SC)

感谢您购买PeriXX产品。 PEIRDU0-606 以其舒适的设计，极具竞争力的价格以及完整的功能性，来满足一般的家庭与办公室的使用需求。透过随插即用的便利性，您无需安装任何额外的驱动程序或软体即可立即使用本产品。

您亦可将本产品与数位多媒体搭配使用，如：多媒体电脑、家庭电影院、网路电视或是车用电脑。

系统需求

- 作业系统：微软Windows XP/7/8/10
- 1 个USB连接口

安装流程

请依照下面的步骤正确连结PERIDU0-606到您的电脑。

1. 打开电脑电源：
2. 装置电池
3. 请将USB无线接收器插入USB口
4. 系统会自动开始安装产品驱动程式，待驱动程式安装完成后若无线连结正常，产品即可顺利运作
5. 如果产品还是无法顺利运作，请再重覆第1个步骤
6. 如果键盘显示没有链接成功，请从电脑上移除接收器，再重新插入接收器后按住键盘底部对码键5秒钟，看到数字切换指示灯会闪烁8秒钟，即表示链接成功。

热键

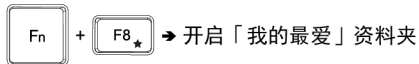
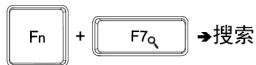
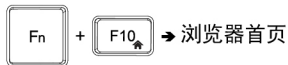
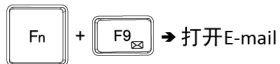



繁體中文(TC)

注意

- 製造商和經銷商不對以下行為所導致的任何技術故障損失或人身傷害承擔責任
 - ▶以任何方式企圖拆除，更改或修改產品引起的故障或損壞
 - ▶由於誤用或不當更改，修理故障引起的故障或損壞
 - ▶購買後摔落產品引起的故障或損壞
 - ▶由於，鹽，氣體，地震，曝曬，風，水，或其他自然災害，或異常電壓引起的故障或損壞
 - ▶由於產品連接到其它設備引起的故障或損壞。
 - ▶由於高溫，潮濕，油膩，多塵和危險的環境引起的故障或損壞
- 請注意，若由未經合規責任方明確批准的變更或修改，可能使使用者失去對設備的操作許可權
- 所有的品牌名稱，商標和標誌是其各自所有者的財產

請注意：長期反覆使用鍵盤和滑鼠可能對用戶造成傷害Perixx建議用戶避免過度使用任何鍵盤和滑鼠。



繁體中文(TC)

感謝您購買PeriXX產品。 PEIRDU0-606 以其舒適的設計，極具競爭力的價格以及完整的功能性，來滿足一般的家庭與辦公室的使用需求。透過隨插即用的便利性，您無需安裝任何額外的驅動程序或軟體即可立即使用本產品。

系統需求

- 作業系統：微軟Windows XP/7/8/10
- 1 個USB連接埠

安裝流程

請依照下面的步驟正確連結PERIDU0-606到您的電腦。

1. 打開電腦電源：
2. 裝置電池
3. 請將USB無線接收器插入USB埠
4. 系統會自動開始安裝產品驅動程式，待驅動程式安裝完成後若無線連結正常，產品即可順利運作
5. 如果產品還是無法順利運作，請再重覆第1個步驟
6. 如果鍵盤還是沒有連結成功，請移除接收器，再重新插入接收器，然後按下鍵盤底部的” connect” 鍵5秒，如果看到指示燈閃爍8秒，就表示連結成功

快捷鍵

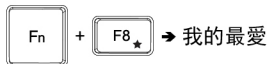
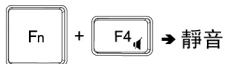
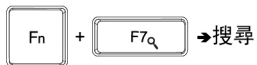
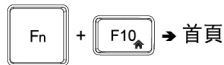

petixx

VALUE
CREATOR