

Modellname:  
Nazwa modelu:

**Nature Plus**

Modellreihe:  
Numer modelu: **1205FF10**

Type: **10**  
Typ: **10**

Blatt Nr 1 von: 6  
Strona z: 6

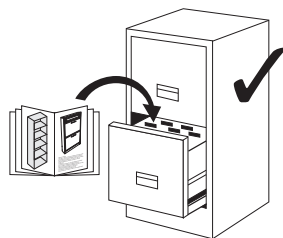

- (D)** Montageanleitung
- (NL)** Handleiding voor de montage
- (TR)** Montaj talimati
- (GB)** Assembly instructions
- (PL)** Instrukcja montażu
- (RU)** Инструкция по монтажу

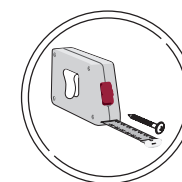
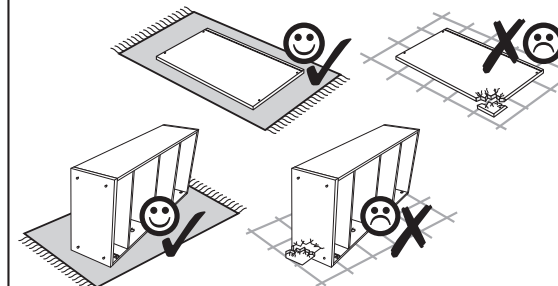
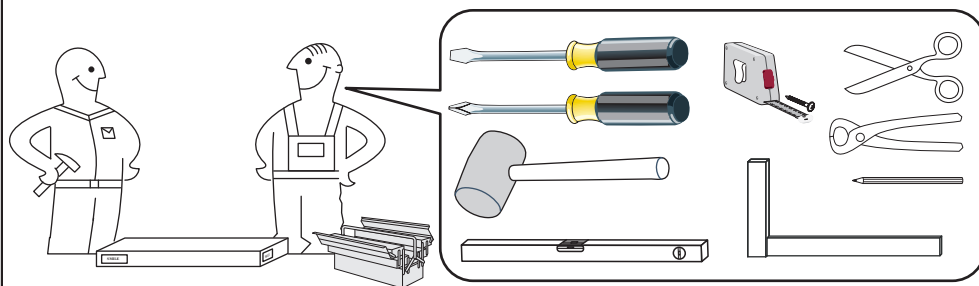
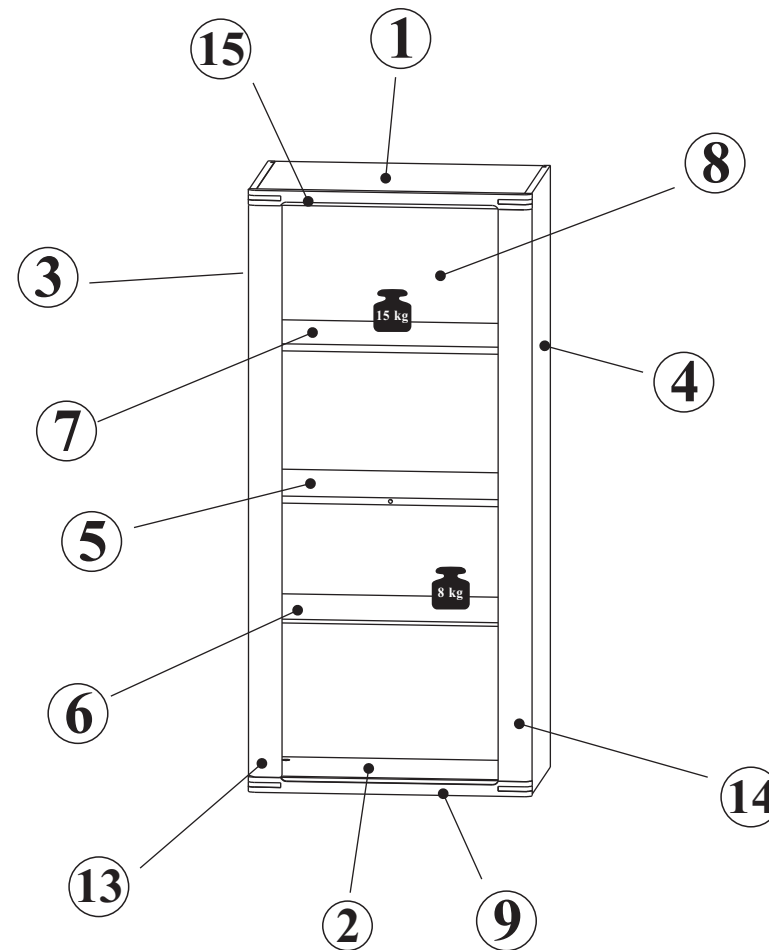
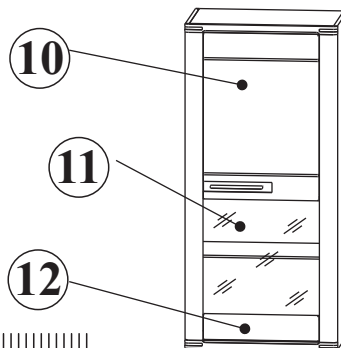

<b>D</b>	Bitte nur mit einem Staubtuch oder leicht feuchtem Lappen reinigen. Keine scheuernden Putzmittel verwenden.
<b>GB</b>	Please only clean with a duster or a damp cloth. Do not use any abrasive cleaners.
<b>NL</b>	Reinig alleen met een stofdoek of een lichtjes vochtige doek. Gebruik geen schurende poetsmiddelen.
<b>PL</b>	Czyszczenie należy wykonać wyłącznie za pomocą ściereczki lub lekko nawilżonego ręcznika. Nie stosować środków czyszczących do szorowania.
<b>TR</b>	Lütfen sadece bir toz bezilye veya hafif nemli yumuşak bir bezle siliniz. Aşındırıcı temizlik malzemeleri kullanmayınız.
<b>RU</b>	Очищайте от пыли тряпкой или слегка влажной ветошью. Не допускается применение чистящих средств, не предназначенных для ухода за мебелью.

<b>D</b>	Stoßen Sie nicht mit harten Gegenständen an die Glasflächen oder -kanten.
<b>GB</b>	Do not bump glass surfaces or edges with hard objects.
<b>NL</b>	Stoot niet met harde voorwerpen tegen de glazen oppervlakken of randen.
<b>PL</b>	Nie uderzać twardymi przedmiotami w szklane powierzchnie i krawędzie.
<b>TR</b>	Cam yüzeylere veya cam kenarlara sert cisimlerle temas etmemeye dikkat ediniz.
<b>RU</b>	Не допускайте ударов твердыми предметами по стеклянным поверхностям или по их краям.

<b>D</b>	Ziehen Sie alle Schrauben sowie tragende Verbindungsteile nach ca. 5 Wochen nach, um eine dauerhafte Standsicherheit zu gewährleisten.
<b>GB</b>	After approx. 5 weeks, tighten all screws and load-bearing connecting parts to ensure permanent stability.
<b>NL</b>	Draai alle schroeven en ook dragende verbindingstukken na ca. 5 weken nog eens vast, zodat een continue stabiliteit wordt gegarandeerd.
<b>PL</b>	Aby zagwarantować trwałą stabilność mocowania należy po ok. 5 tygodniach dokręcić wszystkie śruby oraz elementy łączeniowe.
<b>TR</b>	Tüm vida ve taşıyıcı bağlantı parçalarını kalıcı bir duruş güvenliğini sağlamak için yaklaşık 5 hafta sonra tekrar sıkınız.
<b>RU</b>	Подкрутите все болты, а также несущие соединительные детали прикл. через 5 недель для обеспечения устойчивости в течение длительного времени.

<b>D</b>	Schützen Sie Ihre Möbel generell vor Wasser (z.B. beim Wischen oder Blumen gießen). Die Feuchtigkeit kann in das Möbelstück eindringen und es beschädigen.
<b>GB</b>	In general, keep water away from your furniture (e. g. when mopping or watering plants). The moisture may penetrate the furniture and damage it.
<b>NL</b>	Bescherm uw meubelen doorgaans tegen water (bijv. bij het dweilen of als u de bloemen water geeft). De vochtigheid kan in het meubelstuk dringen en het beschadigen.
<b>PL</b>	Mebel należy chronić przed wodą (np. podczas czyszczenia lub podlewania kwiatków). Wilgoć może wnikać w mebel i uszkodzić go.
<b>TR</b>	Genelde mobilyalannızı sudan koruyunuz (ömeğin, yerleri paspaslarken veya çiçekleri sularken). Nem, mobilya parçasına nüfuz edebilir ve zarar verebilir.
<b>RU</b>	Предохраняйте мебель от попадания воды (например, при вытирании или поливке цветов). Не допускайте попадания влаги на мебель, чтобы предотвратить ее повреждение.

<b>D</b>	Das beigefügte Wandbefestigungsmaterial (Dübel und Schrauben) eignet sich nur für festes Mauerwerk (z.B. Beton- oder Ziegelwände). Für andere Wandaufbauten sind eventuell Spezialdübel und andere Schrauben notwendig. Ziehen Sie gegebenenfalls eine Fachkraft zurate.
<b>GB</b>	The enclosed wall mounting materials (dowels and screws) are only suitable for solid masonry (e. g. concrete or brick walls). Special dowels and other screws may be necessary for other wall constructions. If necessary, please consult a qualified professional.
<b>NL</b>	Het bijgeleverde bevestigingsmateriaal (pluggen en schroeven) is geschikt voor vaste muren (bijv. betonnen of bakstenen muren). Voor andere muurconstructies zijn eventueel speciale pluggen en andere schroeven noodzakelijk. Consulteer eventueel een vakman.
<b>PL</b>	Załączony materiał mocowania w ścianach (kołki oraz śruby) nadaje się wyłącznie do zastosowania w stabilnym murze (np. ściany betonowe lub ceglane). Do montażu ściennych innego rodzaju konieczne są specjalne kołki i inne śruby. W przypadku wątpliwości prosimy zasięgnąć porady fachowca.
<b>TR</b>	Teslimat kapsamındaki duvar tipi sabitleme materyali (dübel ve vidalar) sadece beton ve tuğla duvarlar gibi sağlam duvar yapıları için uygundur. Başka duvar yapıları için özel dübeller veya başka vidalar gerekli olabilir. Gerekirse bir uzmandan yardım alınız.
<b>RU</b>	Входящий в комплект поставки материал для крепления на стене (дюбели и болты) предназначен только для прочных каменных стен (например, бетонных или кирпичных). Для других типов стен используйте по мере необходимости специальные дюбели и другие болты. По мере необходимости обратитесь за помощью к специалистам.

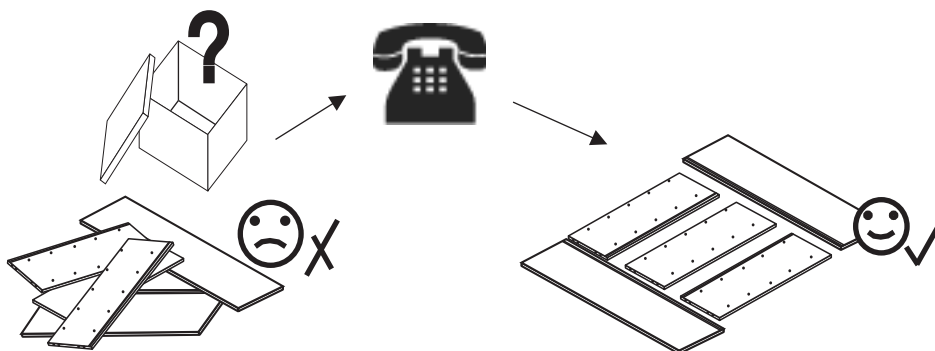

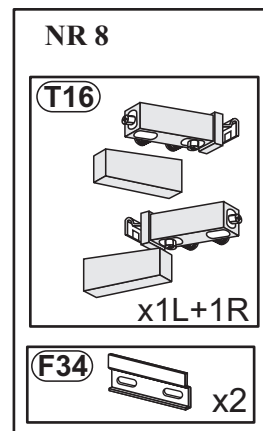
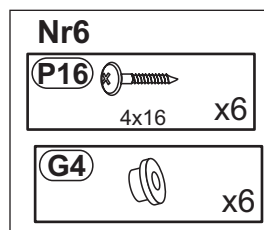
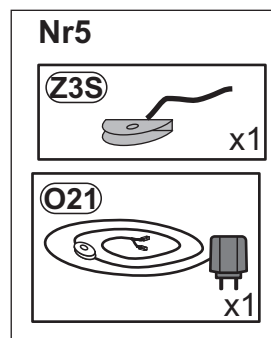
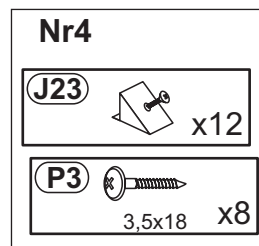
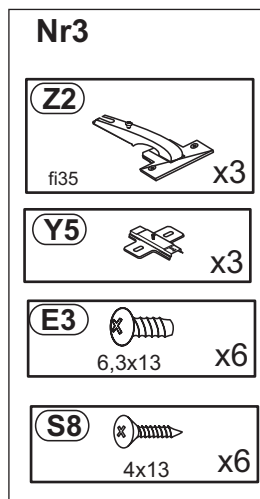
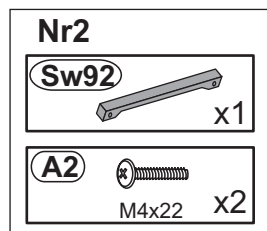
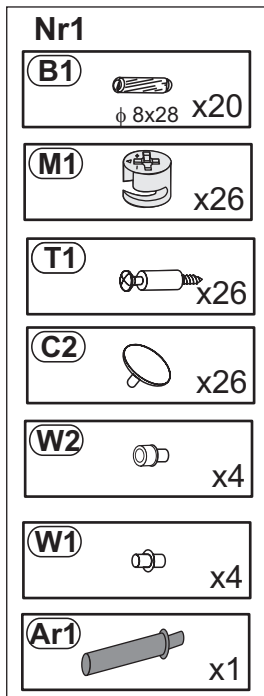

**1**

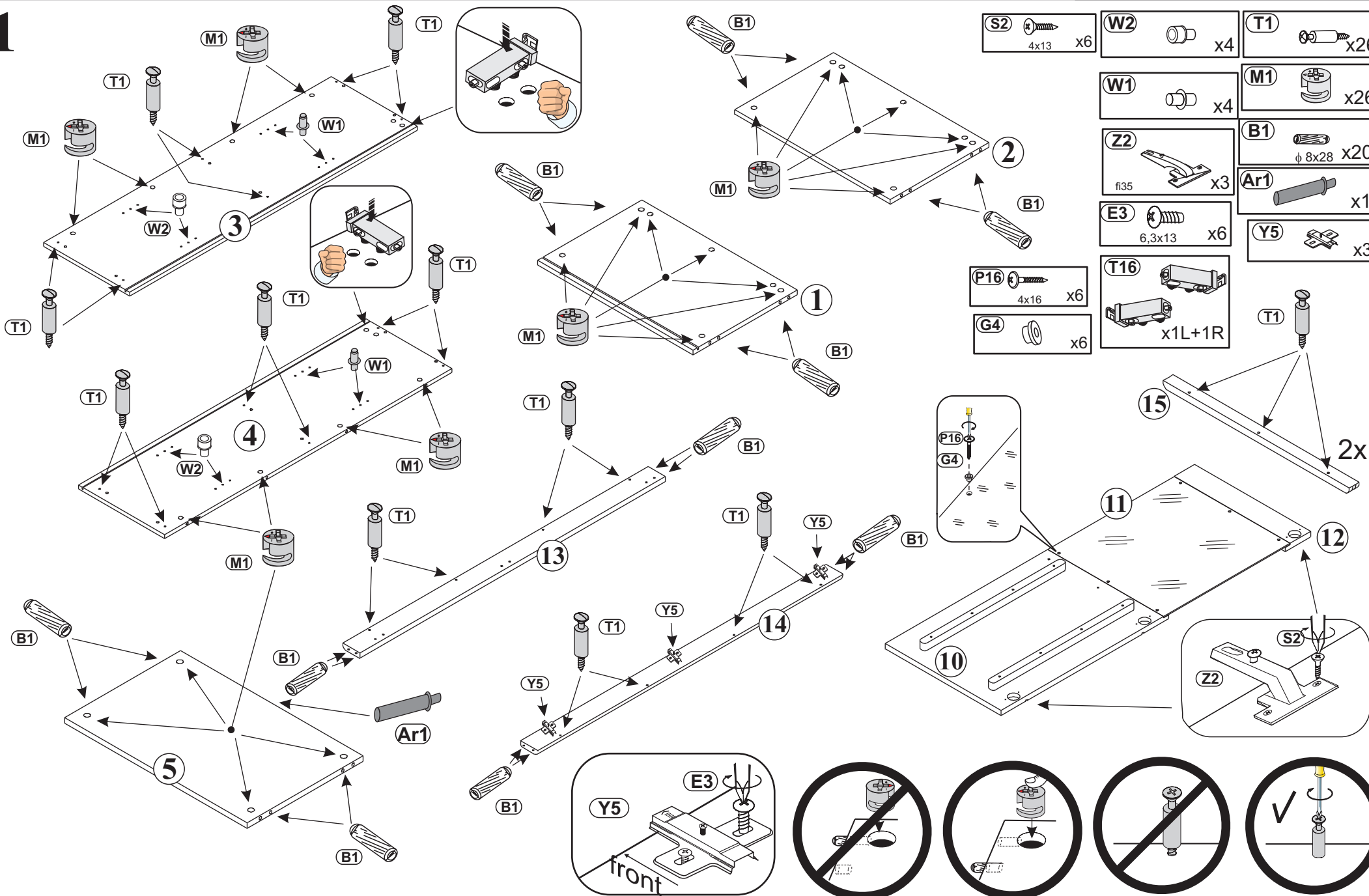

**2**

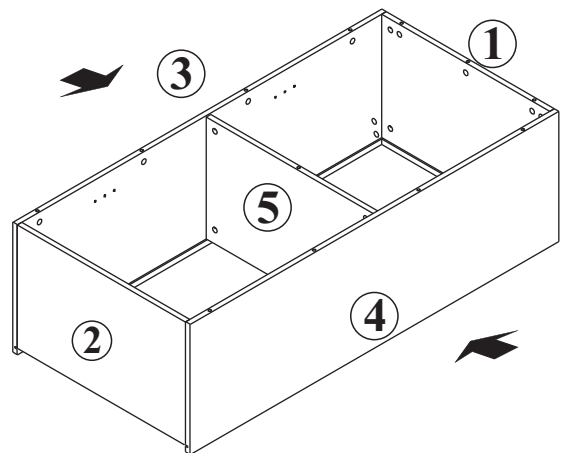

**3**

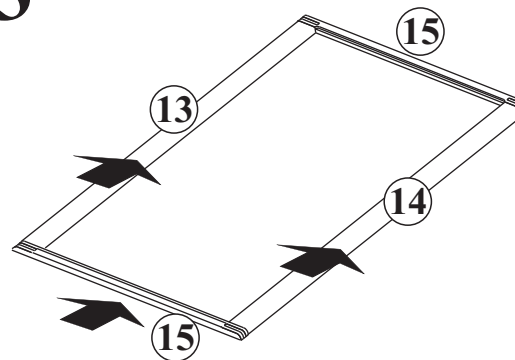

**4**

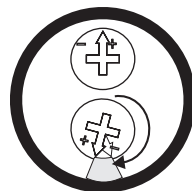
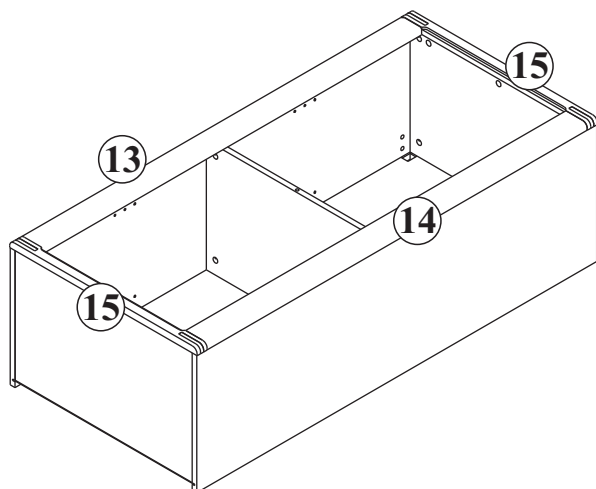

**5**

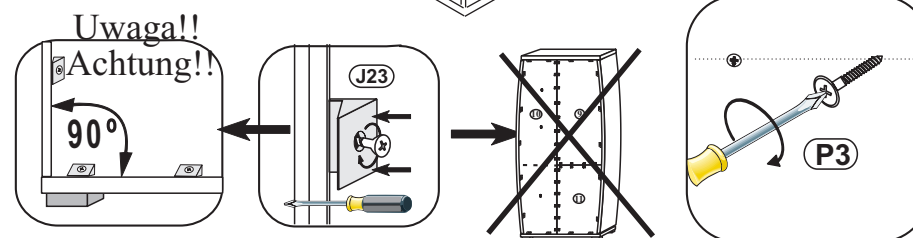
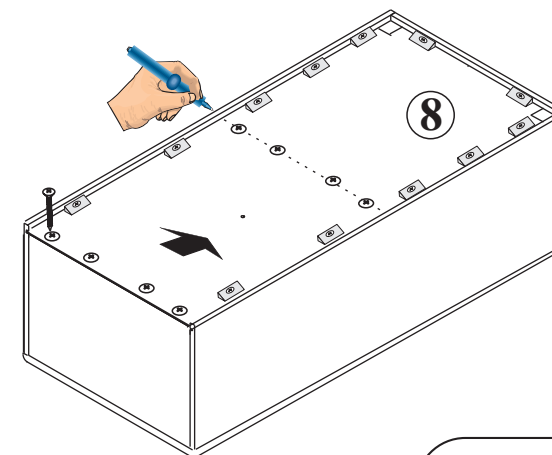
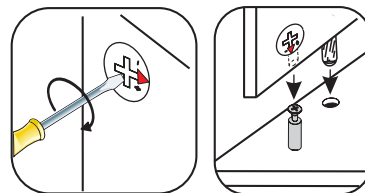
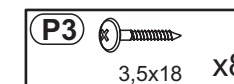
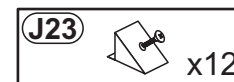

Modellname:  
Nazwa modelu:

# Nature Plus

Modellreihe:  
Numer modelu:

## 1205FF10

Type:  
Typ:

### 10

Blatt Nr  
Strona

von:  
z:

# 6

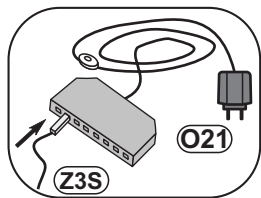
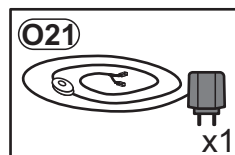
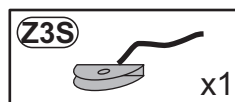
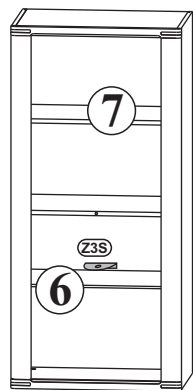

# 7

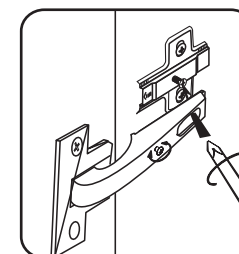
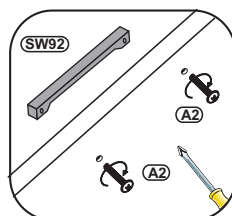
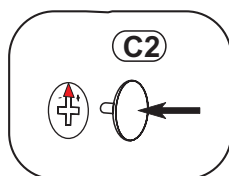
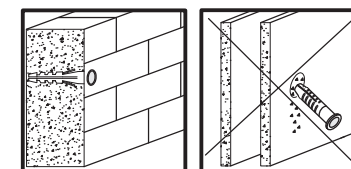
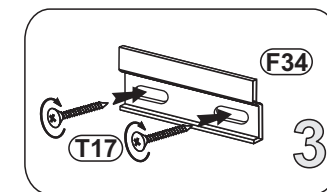
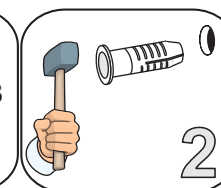
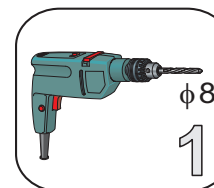
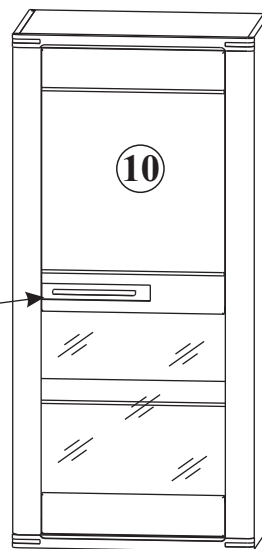
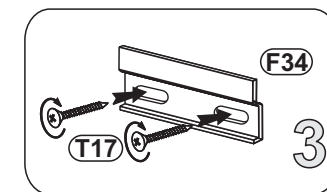
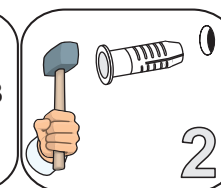
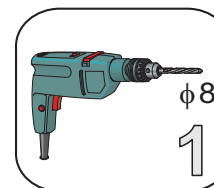
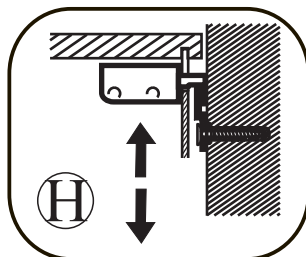
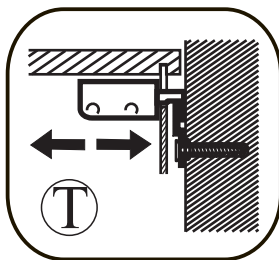
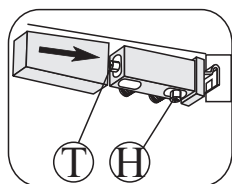
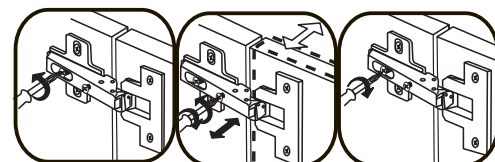
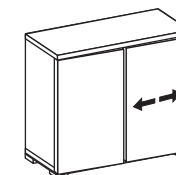
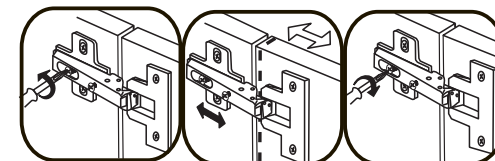
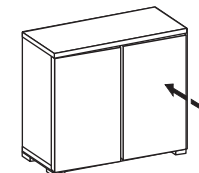
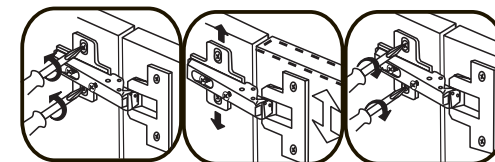
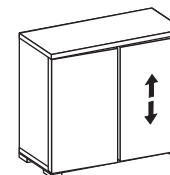
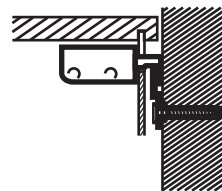
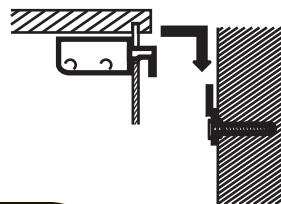
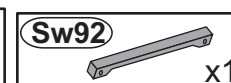
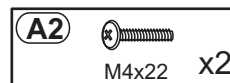
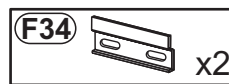

Sehr geehrter Kunde,  
wir gratulieren Ihnen zu dem Erwerb Ihres neuen Möbelstücks. Da wir auf die Zufriedenheit unserer Kunden größten Wert legen, bitten wir Sie, bevor Sie mit der Montage anfangen, den Inhalt des Beschlagbeutels sorgfältig zu überprüfen. Sollte wirklich ein Teil fehlen, kennzeichnen Sie dieses bitte deutlich in den vorgesehenen Kästchen der Beschlag-Servicekarte und geben die fehlende Stückzahl an. Schicken Sie die Anforderungskarte per Post, Fax an **Nummer + 49 (0) 5281/62141-69**, Bitte beachten Sie, dass nur die angegebenen Beschlagteile auf diesem Wege verschickt werden können.

Sollten Sie sonstige Wünsche haben, so wenden Sie sich bitte an Ihren Händler, bei dem Sie die Möbel gekauft haben.

Bitte  
knicken

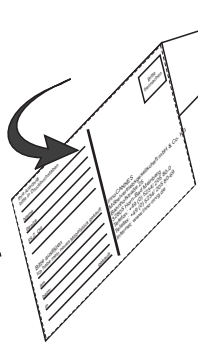

und zusammen-  
kleben

Beispiel:



## BESCHLAG - SERVICEKARTE

Modellname: Nature Plus Type: 10

Modellreihe: 1205FF10

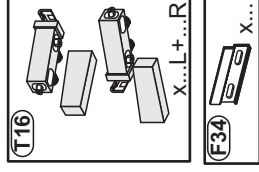
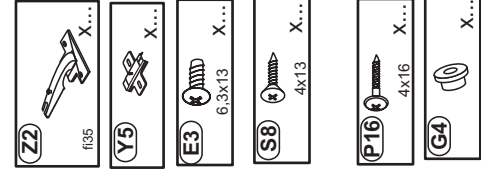
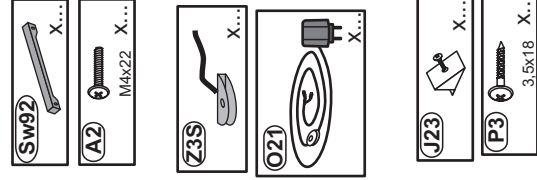
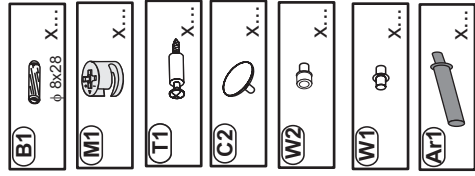

Ihre Anschrift  
bitte in Druckbuchstaben

Name:

Straße:

PLZ, Ort:

Bitte ausfüllen

Ich habe mein neues Möbelstück gekauft

am:

bei Fa:

in:

Kaufvertragsnummer des Möbelhauses  
(falls vorhanden)

Bitte  
freimachen

iNNOstyle  
Möbelvertriebs GmbH & Co. KG  
Pyrmonter Strasse 66  
D-32676 Lügde

