

JANINA L

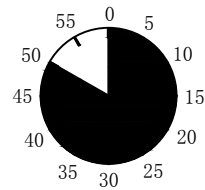

1

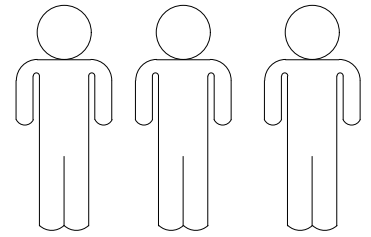
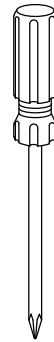
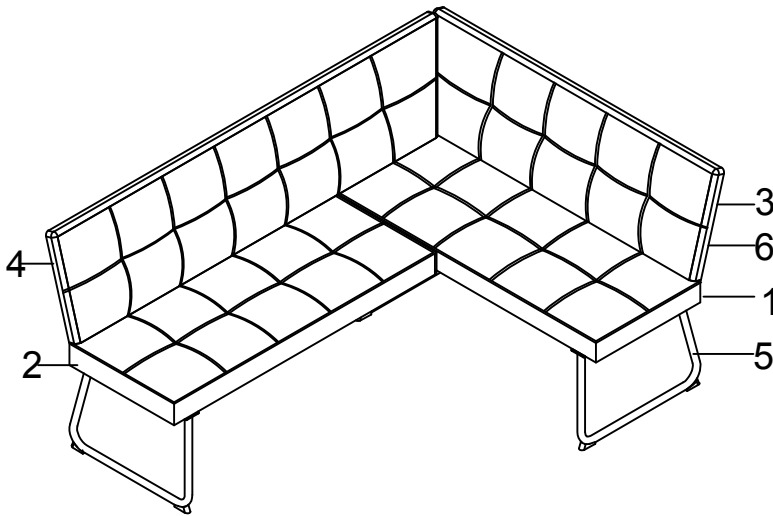
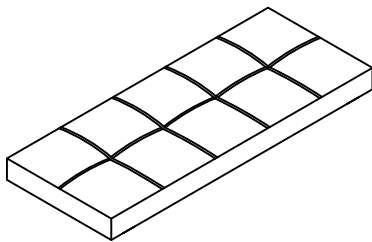

2

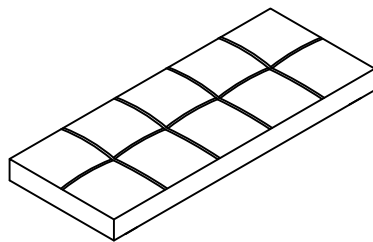

3

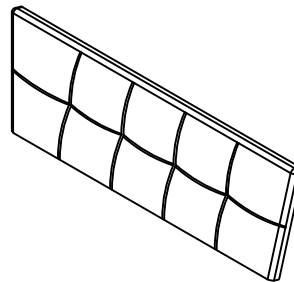

4

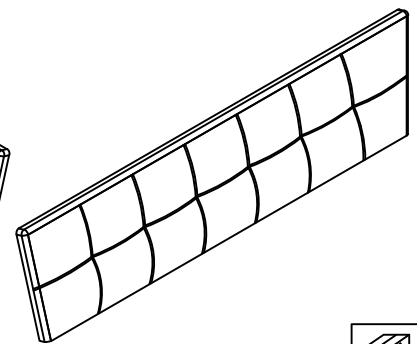

5

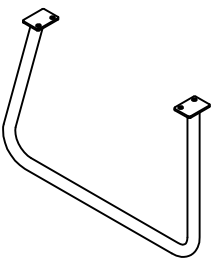

6

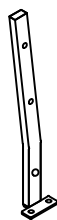



1	1x	2/3
2	1x	2/3
3	1x	1/3
4	1x	1/3
5	3x	3/3
6	5x	3/3



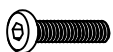

3/3

A M8*18

 22X

B M8*35

 14X

C M8*45

 5X

D Ø18*Ø8*1.5

 41X

E M4*20

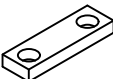
 12X

F

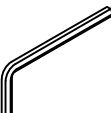
 6X



G

 2X

H 5mm

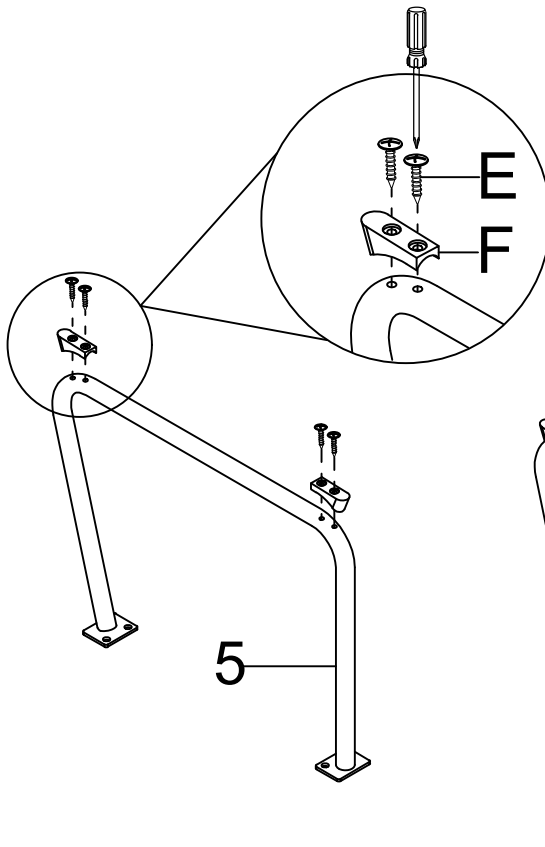
 1X

I.





1.

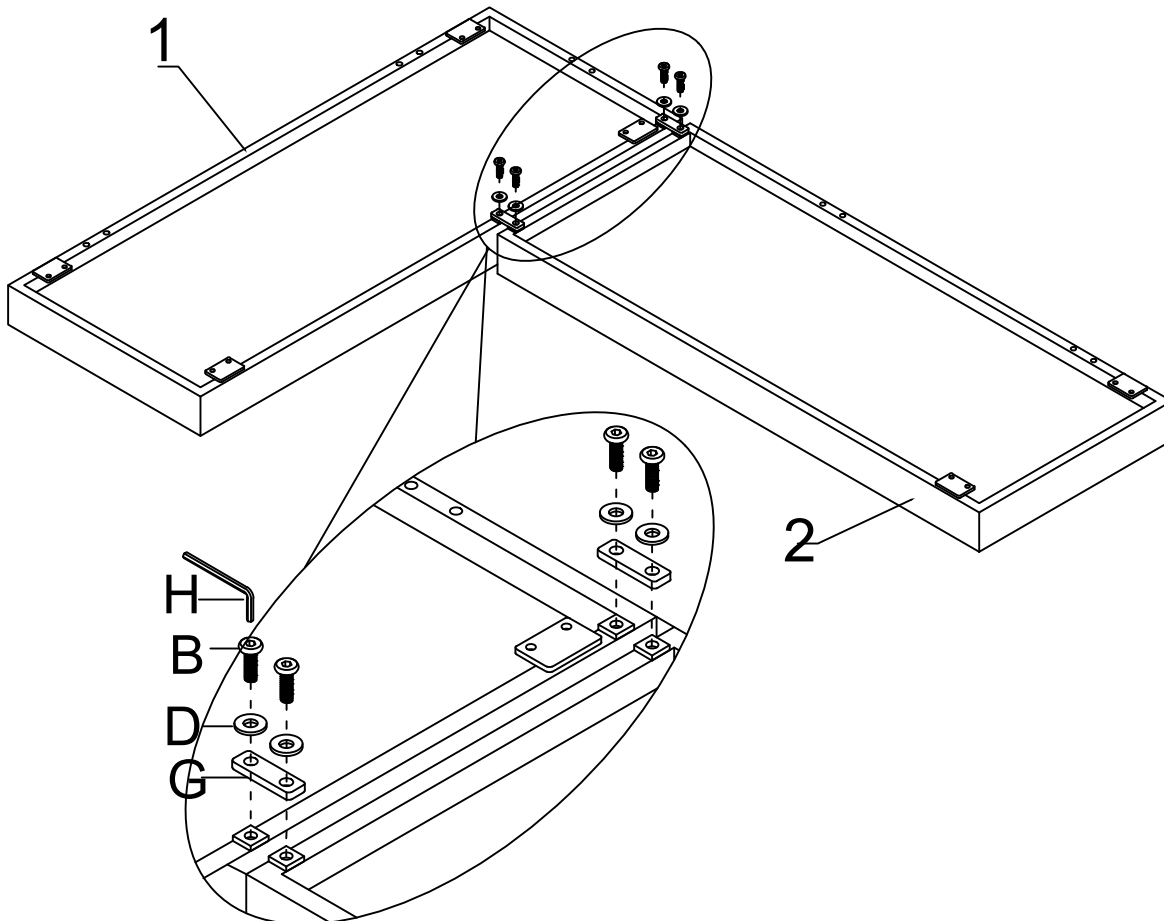

E	M4*20
	12X
F	
	6X
	100%

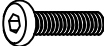
2.

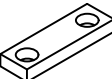





B	M8*35
	4X
D	Ø18*Ø8*1.5
	4X
G	
	2X
H	5mm
	1X
	100%

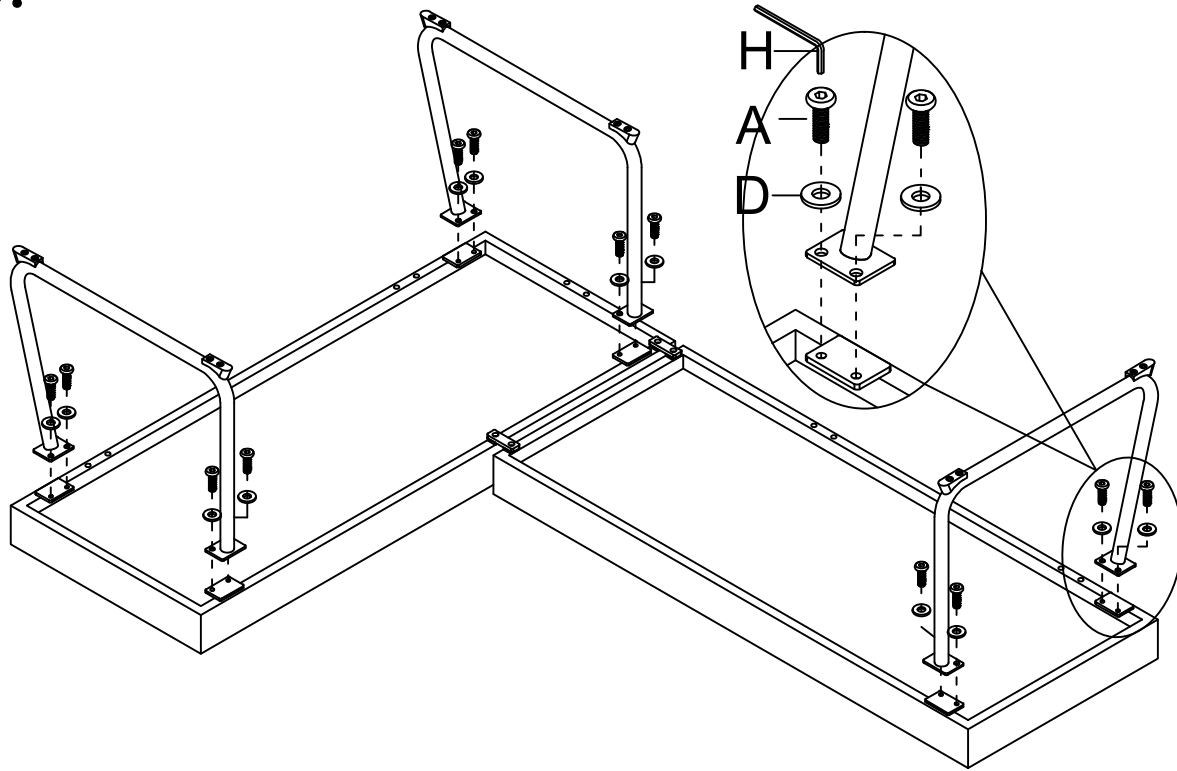



II.

3.

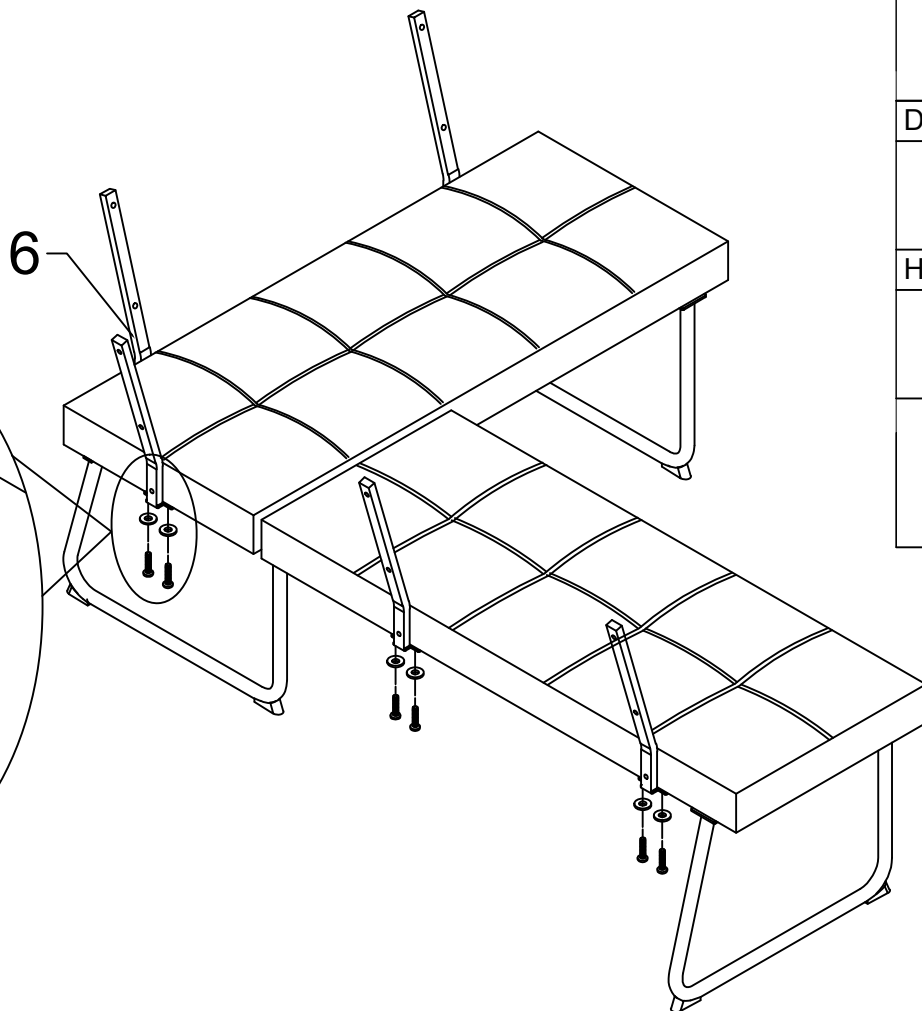

A	M8*18
	
	12X
D	Ø18*Ø8*1.5
	
	12X
H	5mm
	
	1X
	



A	M8*18
	
	10X
D	Ø18*Ø8*1.5
	
	10X
H	5mm
	
	1X
	

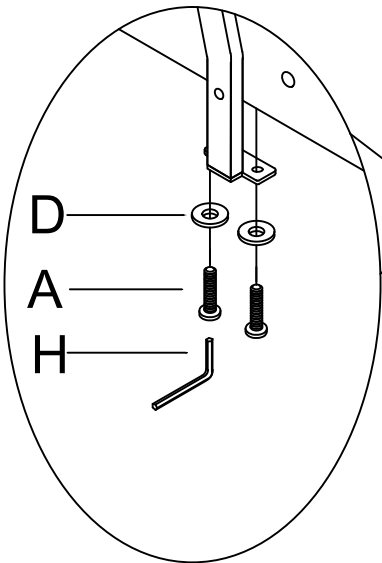

III.

5.

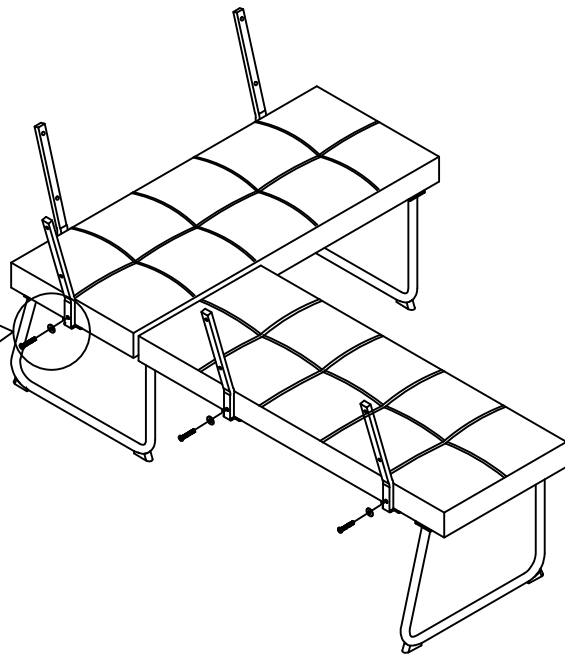
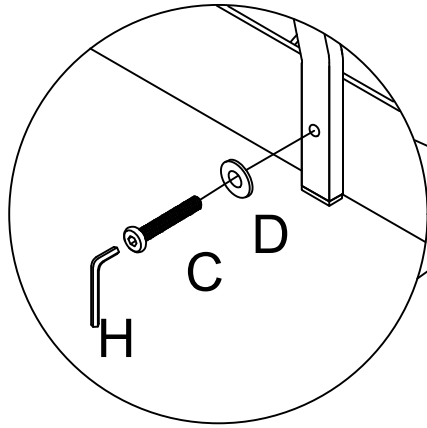

- C M8*45
5X
- D Ø18*Ø8*1.5
5X
- H 5mm
1X
- 75%

6.

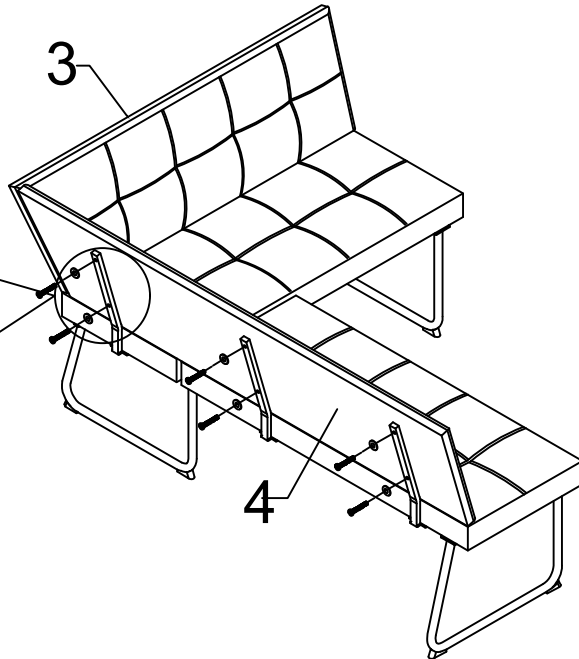
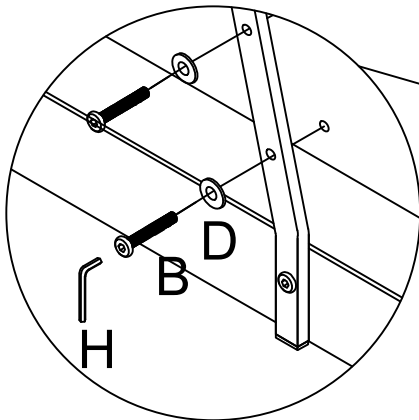

- B M8*35
10X
- D Ø18*Ø8*1.5
10X
- H 5mm
1X
- 75%

7.

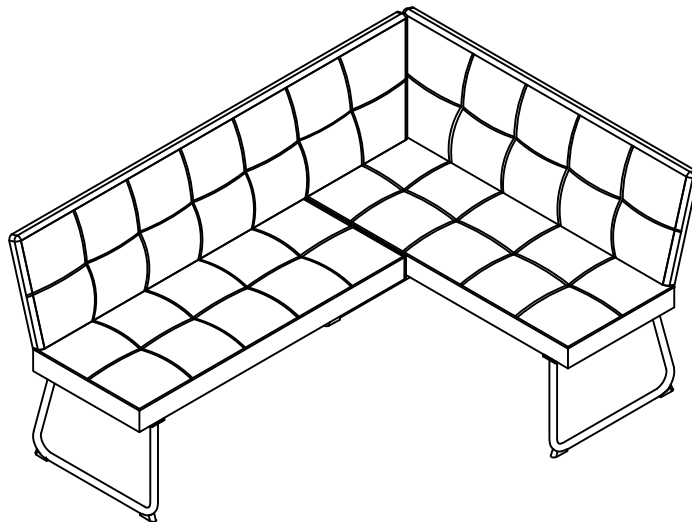

- H 5mm
1X
- 100%



Séparez les éléments avant de trier