

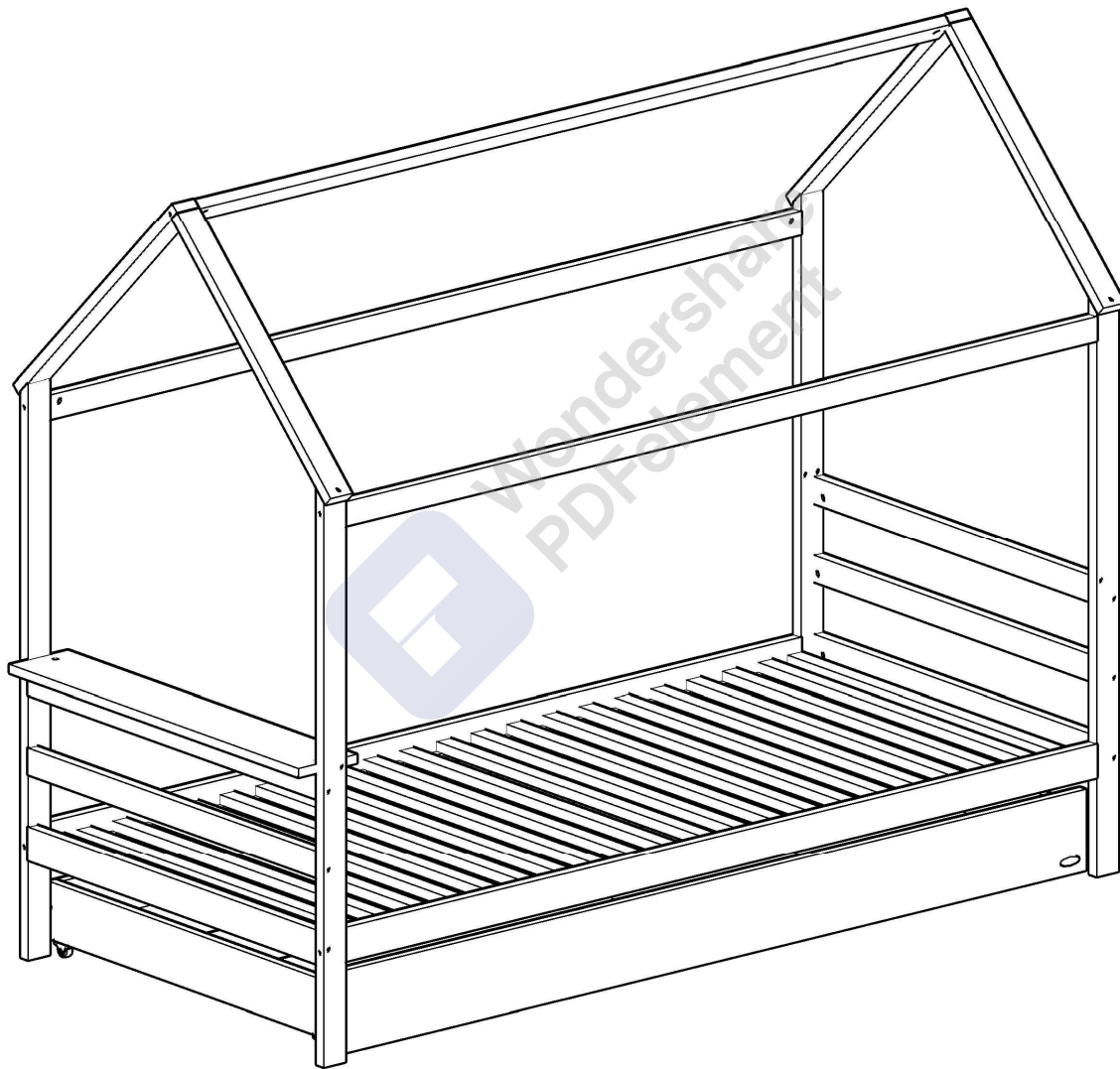

## BED Assembly instructions

**Actual product size**

H170 x W205 x D101cm





# BEFORE YOU START

## IMPORTANT - RETAIN FOR FUTURE REFERENCE - READ CAREFULLY.

### Number of people required to assemble

Two persons are required to assemble this item

### Time to assemble



1,5 hours

### Tools required

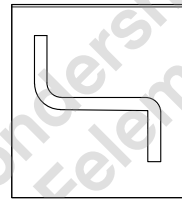

This bed conforms to BS EN 1725:1998

#### WARNINGS

##### WARNING:

Children are likely to play, bounce, jump and climb on beds, therefore the child's bed should not be placed too close to other furniture or windows, blind cords, curtain pulls or other strings or cords and should be placed either tight to any wall or have a gap of 300mm between the wall and the side of the bed

WARNING: Be aware of the risk of open fire and other heat sources of strong heat, such as electric bar fires, gas fires, etc. in the near vicinity of the bed

WARNING: Do not use the bed if any part is broken, torn or missing and use only spare parts approved by the manufacturer

WARNING: Do not use more than one mattress in the bed

The beds should not be placed too close to other furniture or windows, and should be placed either tight against a wall or have a gap of 300mm between the wall and the side of the bed.

WARNING: Assembly by adult only.

Once the mattress is placed on the bed base, make sure the gap between the mattress and the sides and ends can not exceed 30mm

Do not leave anything in the bed, which could provide a foothold or present a danger of suffocation or strangulation

Assembly fittings should always be tightened properly and care should be taken that no screws are loose to ensure baby does not trap parts of the body, or clothing

We recommend the size of the mattress: L 1600 mm x W 800 mm x H 100 mm

#### Do's

When you are ready to start, make sure that you have the right tools and plenty of space

Due to the size of the product we recommend that it is assembled in the room intended for use

Unwrap all packaging materials and place the components on a clean surface to protect it from damage,

We recommend that the packaging is used to protect the surfaces during assembly

Carefully check that you have all the parts before beginning assembly

Occasional overall cleaning should be carried out approximately once a month by using a slightly dampened soft cloth then buff with a dry clean soft cloth

Never allow any kind of liquid to remain on your furniture. Absorption can cause finishes to de-laminate.

When moving your assembled bed, it is best to lift the bed, and never to drag it

Please periodically check the stability and security of the beds. Please periodically check the fasteners and re-tighten as necessary

#### Don'ts

Please do not jump on your furniture

Keep away from fire and other sources of strong heat, such as electric bar, fire, gas fire etc

Do not drag or pull your furniture

Do not use silicone based furniture polish. Silicone in furniture polishes can break down the lacquer finish



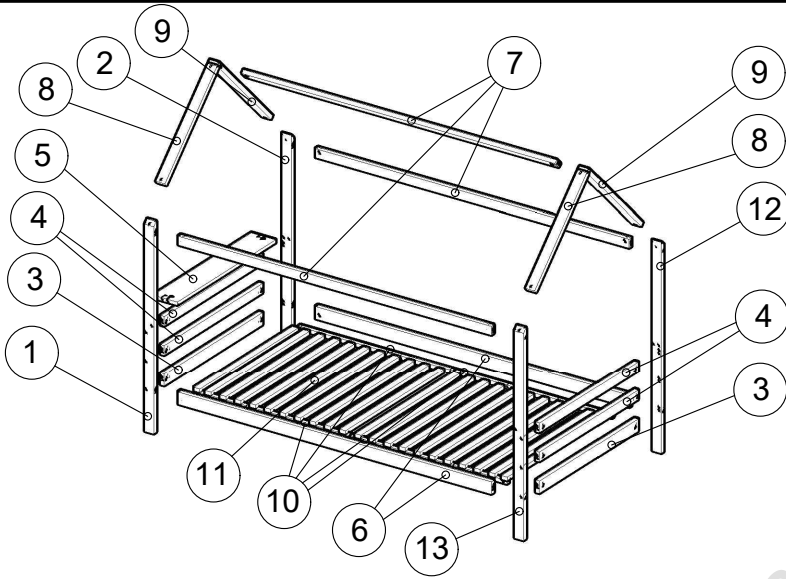

Do not stand or jump on this product

# Alcube®

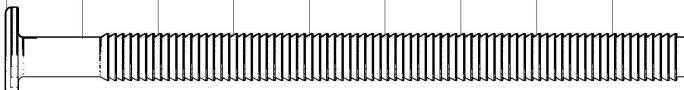

Ref	Größe / Size	Ansicht/Visual	Qty	Ctn	Ref	Größe / Size	Ansicht/Visual	Qty	Ctn
1	1200 x 5,5cm		1	1	10	97 x 2 cm		4	1
2	1200 x 5,5cm		1	1	11	200 x 90 cm		1	1
3	90 x 7 cm		2	1	12	1200 x 5,5cm		1	1
4	90 x 5,5 cm		4	1	13	1200 x 5,5cm		1	1
5	90 x 15 cm		1	1					
6	193 x 7 cm		2	1					
7	193 x 5 cm		3	1					
8	68 x 5,5 cm		2	1					
9	70 x 5,5 cm		2	1					

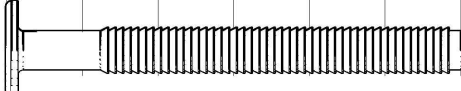
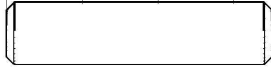

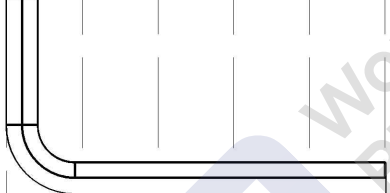
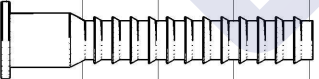
Ref	Größe / Size	Qty	mm
A	6 x 90 mm	14	
B	10 x 13 mm	30	
C	7 x 60 mm	16	
D	8 x 35 mm	20	
E	3 x 35 mm	22	
F	N/A	1	
G	7 x 40 mm	4	

**1**

3 x 35 mm  
E x 12

**2**

D x 14 8 x 35 mm

B x 14 10 x 13 mm

6 x 60 mm C x 14

**3**

B x 2 10 x 13 mm

6 x 60 mm C x 2

7 x 40 mm G x 6

**4**

D x 10 8 x 35 mm

B x 14 10 x 13 mm

6 x 90 mm A x 14

**5**

3 x 35 mm E x 6