

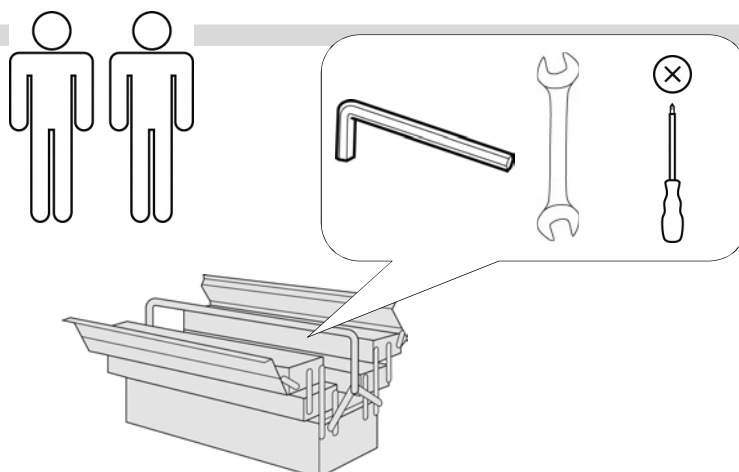

- | | |
|----------------------------------|---------------------------------------|
| D Montageanleitung | GB Assembly instructions |
| FR Notice de montage | NL Handleiding voor de montage |
| CZ Montážní návod | IT Istruzioni di montaggio |
| RO Instrucțiuni de montaj | RU инструкция по сборке |
| PL Instrukcja montażu | SK Návod na montáž |
| HU Szerelési útmutató | TR Montaj talimati |



Bei der Montage Kopfteilbrett unbedingt beachten !

**Bettkasten
Außenseite**

**Teil 4
Bettseite-
Innen**

Kopfteilbrett vor der Montage

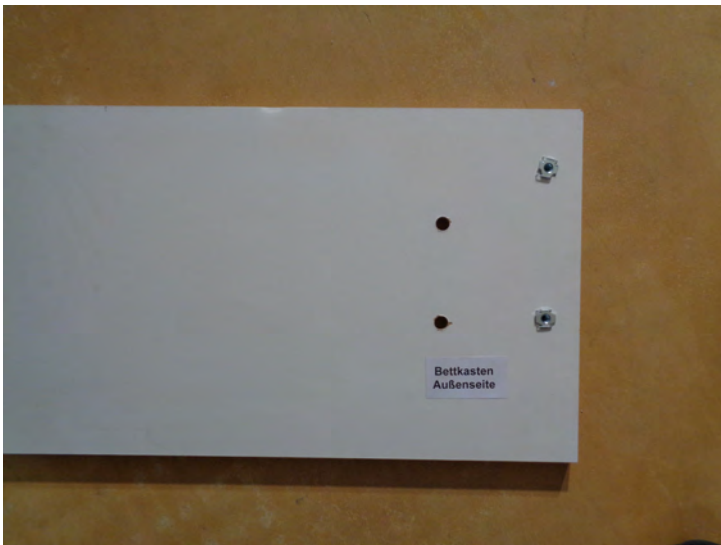

Kopfteilbrett nach der Montage



0
10
20
30
40
50
60
70
80
90
100
110
120
130
140
150
160
170
180
190
200



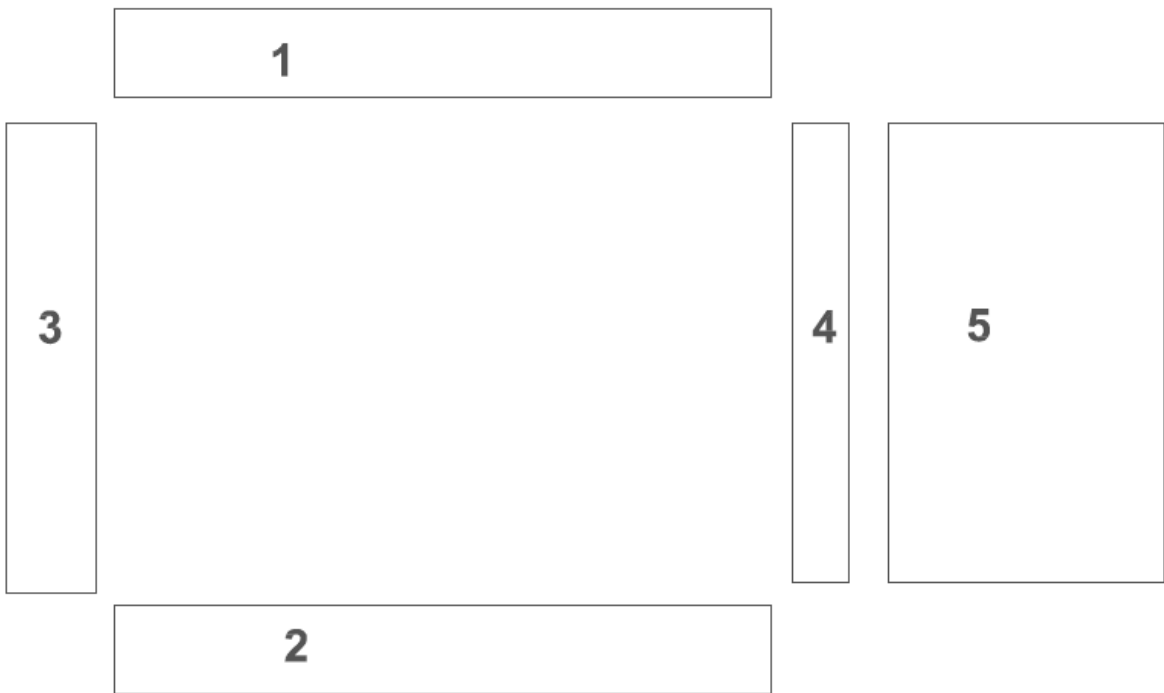

Service • Assistenza • Dienstverlening • Serwis Servis • Szerviz • Сервисная служба	
Name • Nom • Nome • Naam Nazwa • Jméno • Názov • Név Denumire • İsim • Название	Fraser EB
Nr. • No. • N° • Номер • Č • Sz	SH47-55
Typ • Type • Tip • Típus • Тіро Тип	BK zerl.

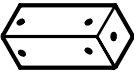

A	B	C	D	E
16x 6x30	4x	16x 3,5x20	4x	4x

G	H	I
4x M8x20	4x 8x20	4x

P	Q	R
4x 8x70	4x 8x30	4x M8

A		16x 6x25
B		4x
C		16x 3,5x20
D		4x
E		4x

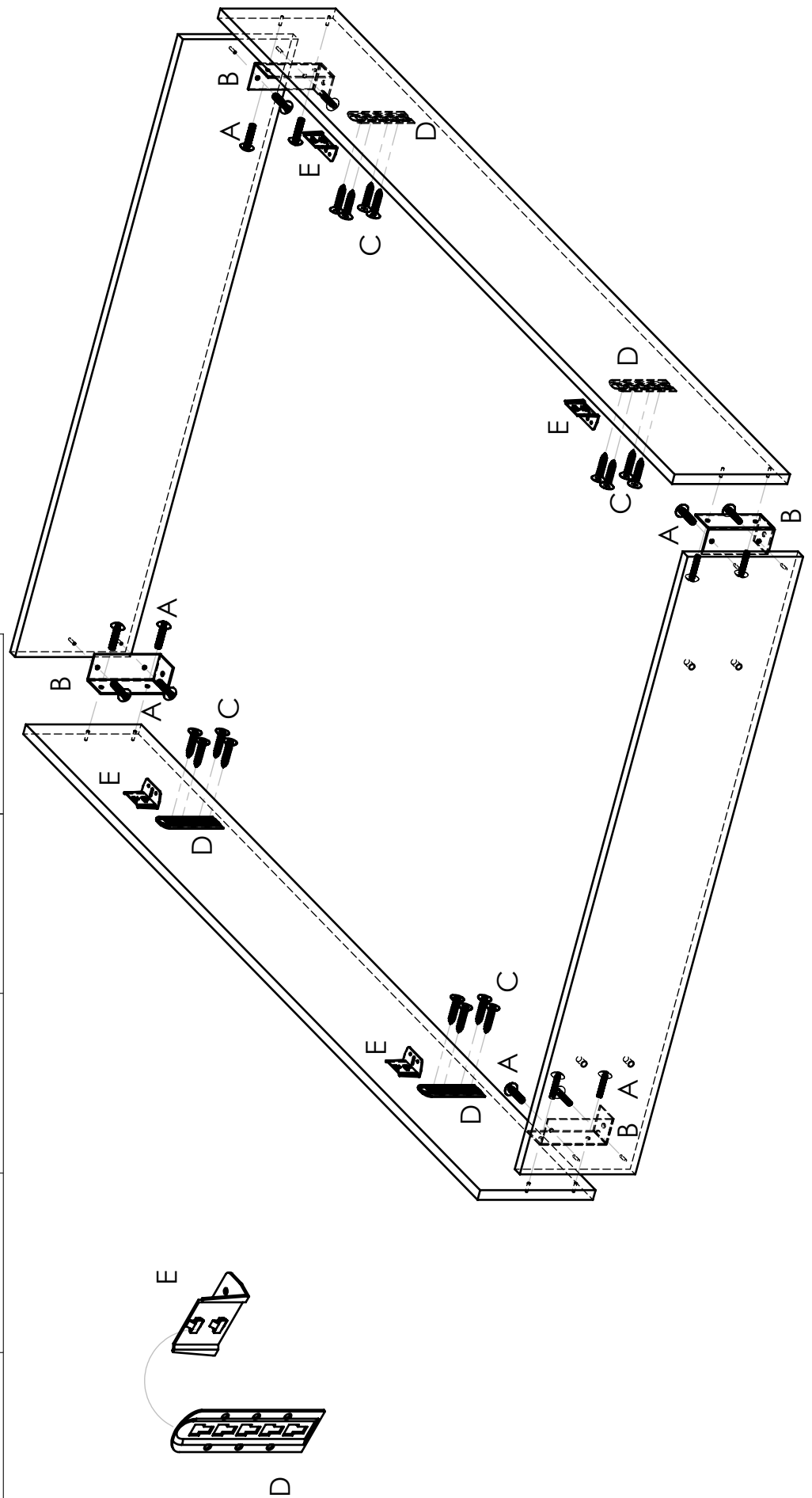

2.

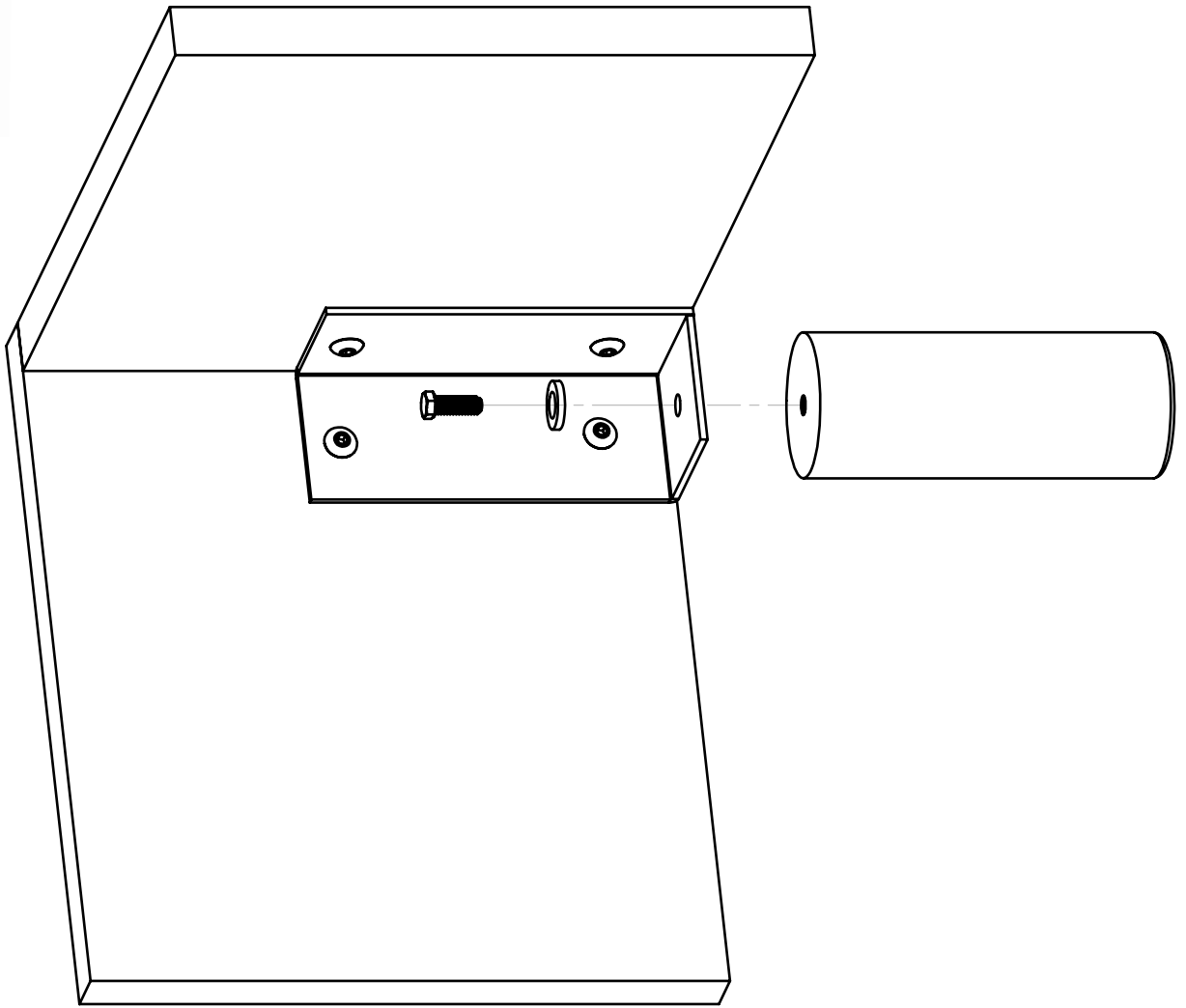

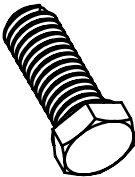
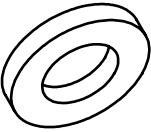
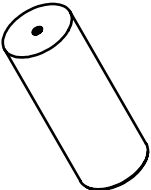

G		4x M8x20
H		4x 8x20
I		4x

3.

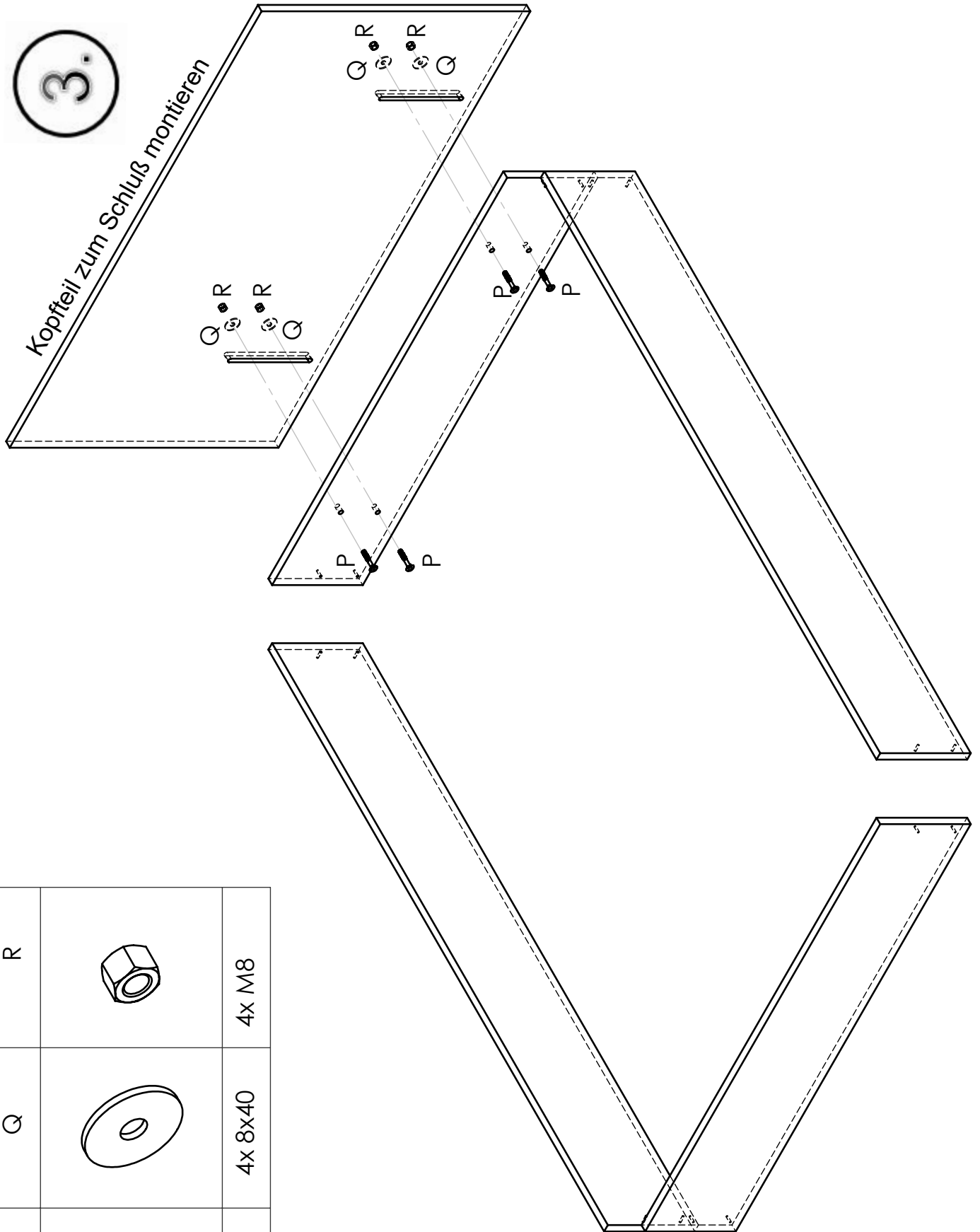
Kopfteil zum Schluß montieren

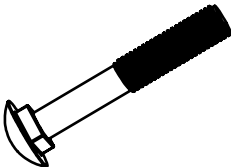
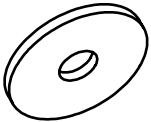

P		4x 8x70
Q		4x 8x40
R		4x M8