

Hamburg

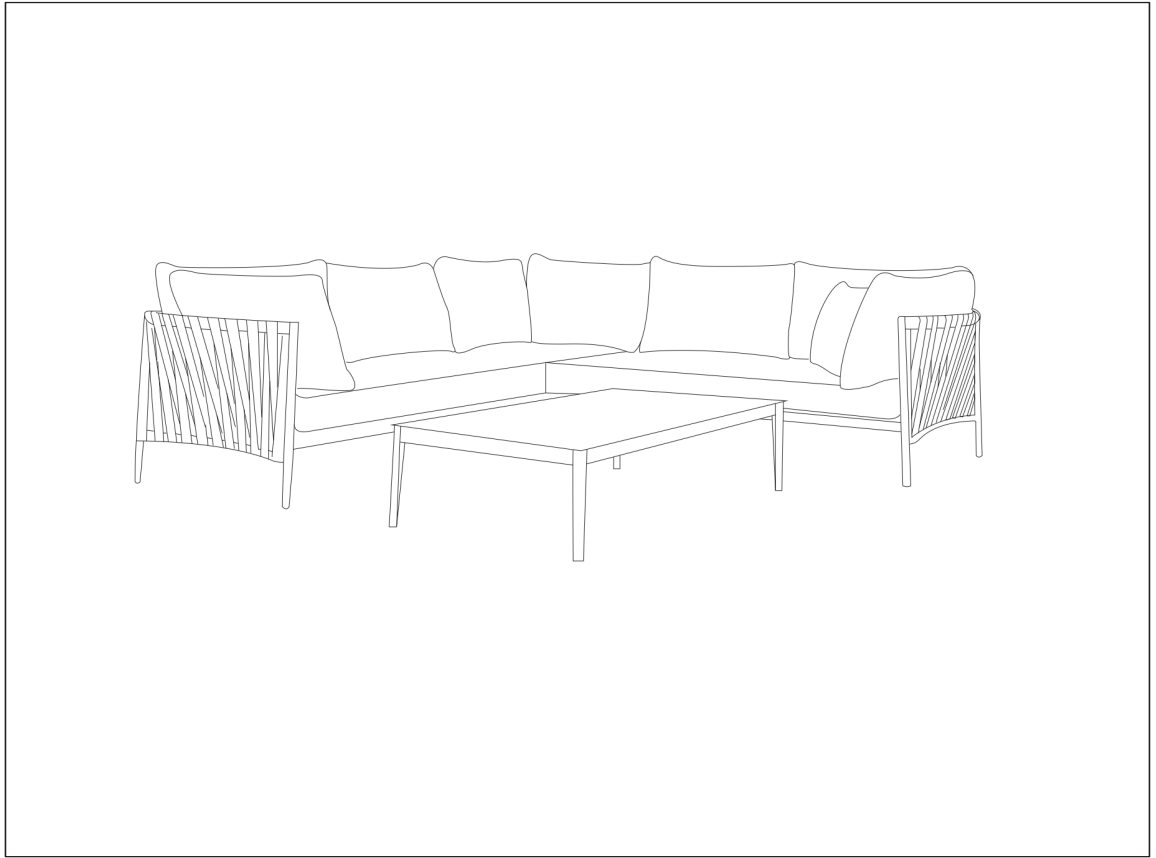

- | | | | |
|------|-----------------------------|------|-------------------------|
| Ⓝ DE | Montageanleitung | Ⓝ GB | Assembly instructions |
| Ⓝ FR | Notice de montage | Ⓝ IT | Istruzioni di montaggio |
| Ⓝ NL | Handleiding voor de montage | Ⓝ PL | Instrukcja montażu |
| Ⓝ CZ | Montážní návod | Ⓝ SK | Návod na montáž |
| Ⓝ HU | Szerelési utmutató | Ⓝ RO | Instrucțiuni de montaj |
| Ⓝ TR | Montaj talimatı | Ⓝ RU | Инструкция по монтажу |



Ausgabe: 20221105

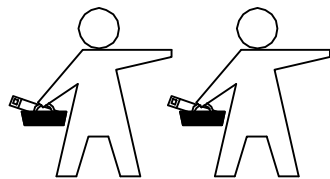

**D: WICHTIG, FÜR SPÄTERE BEZUGNAHME DIESES DOKUMENT AUFBEWAHREN!
SORGFÄLTIG LESEN!**

Dieses Außenmöbel ist nur zur Verwendung im privaten Wohnbereich vorgesehen.

GB: IMPORTANT, HOLD ON TO THIS DOCUMENT FOR LATER REFERENCE! READ CAREFULLY!

This outdoor furniture is only intended for use in private residential areas.

FR: IMPORTANT, CONSERVER CE DOCUMENT POUR VOUS Y RÉFÉRER ULTÉRIEUREMENT! LE LIRE ATTENTIVEMENT!

Ce meuble d'extérieur n'est prévu que pour une utilisation dans le domaine privé.

IT: IMPORTANTE, CONSERVARE LE PRESENTI ISTRUZIONI PER OGNI ULTERIORE CONSULTAZIONE! LEGGERE CON ATTENZIONE!

Il presente mobile da esterno è previsto solo per l'uso in ambito domestico.

**NL: BELANGRIJK, BEWAAR DIT DOCUMENT ALS REFERENTIE IN DE TOEKOMST!
ZORGVULDIG LEZEN!** Dit buitenmeubel is alleen bedoeld voor het gebruik in privéwoningen.

PL: WAŻNE, DOKUMENT PRZECHOWAĆ NA PRZYSZŁOŚĆ JAKO MATERIAŁ REFERENCYJNY! DOKŁADNIE PRZECZYTAĆ!

Ten mebel zewnętrzny jest przewidziany jedynie do użytku w prywatnych strefach mieszkalnych.

RO: IMPORTANT! PĂSTRAȚI ACEST DOCUMENT PENTRU CONSULTAREA ULTERIOARĂ! CITIȚI CU ATENȚIE!

Acest mobilier de exterior este destinat doar utilizării în zonele de locuit private.

RU: ВАЖНО СОХРАНИТЬ ЭТОТ ДОКУМЕНТ ДЛЯ ИСПОЛЬЗОВАНИЯ В ДАЛЬНЕЙШЕМ! ВНИМАТЕЛЬНО ОЗНАКОМЬТЕСЬ С НИМ!

Этот предмет уличной мебели предназначен только для использования в частных жилых зонах.

**SK: DÔLEŽITÉ, USCHOVAJTE SI TENTO DOKUMENT PRE BUDÚCE POUŽITIE!
ČÍTAJTE POZORNE!**

Tento vonkajší nábytok je určený len na použitie v súkromnom obytnom priestore.

**CZ: DŮLEŽITÉ! TENTO DOKUMENT SI USCHOVEJTE PRO POZDĚJŠÍ POUŽITÍ.
ČTĚTE POZORNĚ!**

Tento venkovní nábytek je určený pouze k použití v soukromém obytném prostoru.

HU: FONTOS – KÉSŐBBI FELHASZNÁLÁSRA ŐRIZZE MEG EZT A DOKUMENTUMOT! GONDOSAN OLVASSA EL!

Ez a kültéri bútor csak magán lakóterületen történő használatra szolgál.

**TR: ÖNEMLİ, DAHA SONRA FAYDALANMAK İÇİN BU DOKÜMANI SAKLAYIN!
DİKKATLİCE OKUYUN!**

Bu dış mekan mobilyası sadece özel oturma alanında kullanılması için tasarlanmıştır.



0
10
20
30
40
50
60
70
80
90
100
110
120
130
140
150
160
170
180
190
200

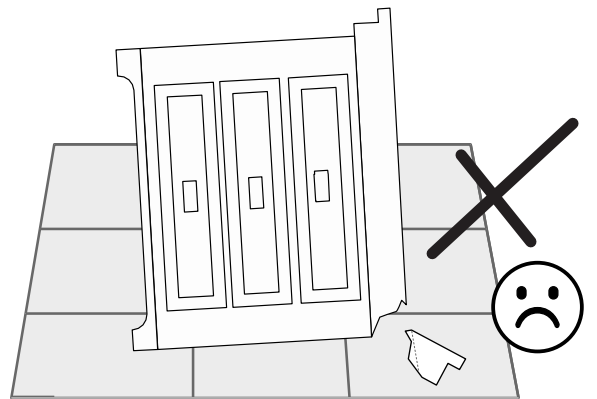
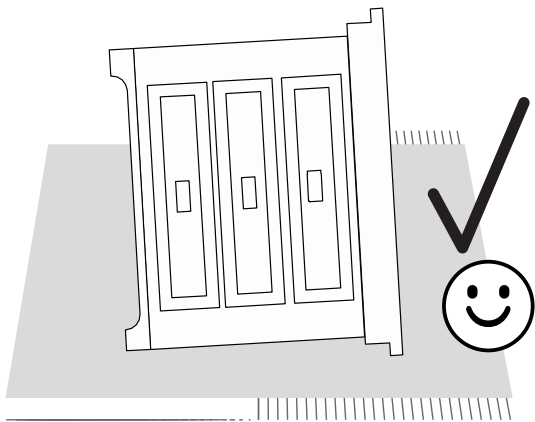

Service	
Name	Hamburg
No.	56858333 96636313
EAN	4251942238433
Type	

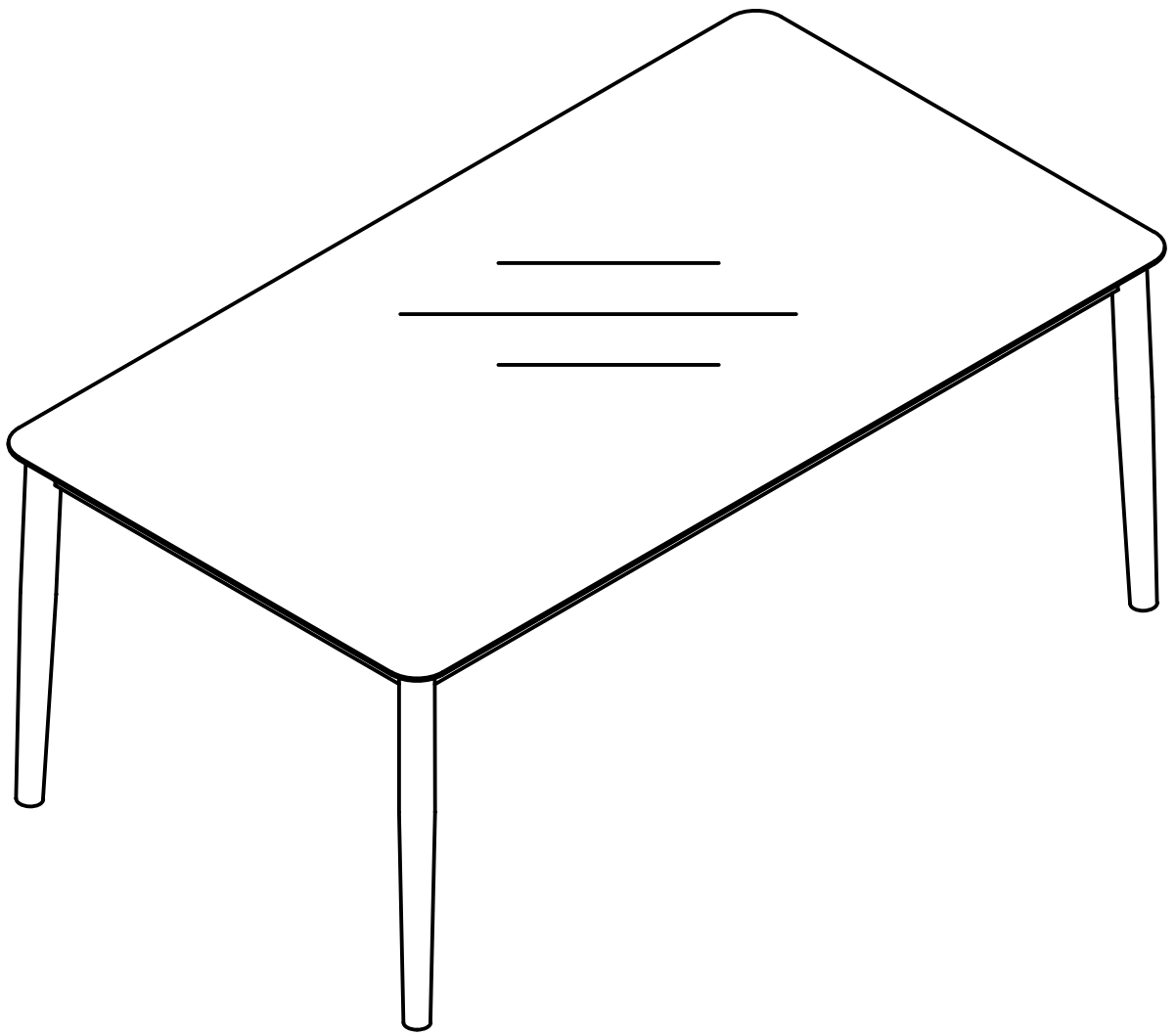
The diagram illustrates a service process. A telephone icon is at the top, with arrows pointing to a sad face (left) and a happy face (right). A question mark is positioned above a box with an arrow pointing to the sad face. Below this, there are four illustrations of furniture: a chair with a trash can, a desk with a book, a broken chair, and a broken desk.

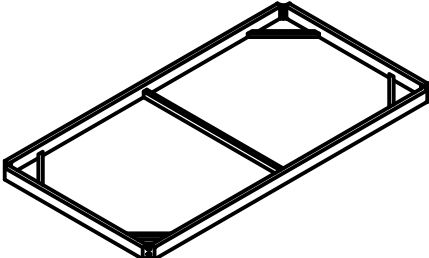

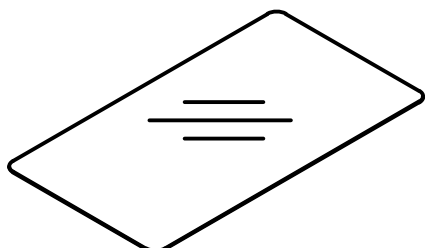

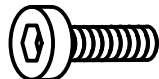
A		1PC
B		4PCS
C		1PC

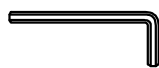
1	 M8*35	8PCS
2	 ø8*16	8PCS
3	 Allen key 5*60	1PC

1

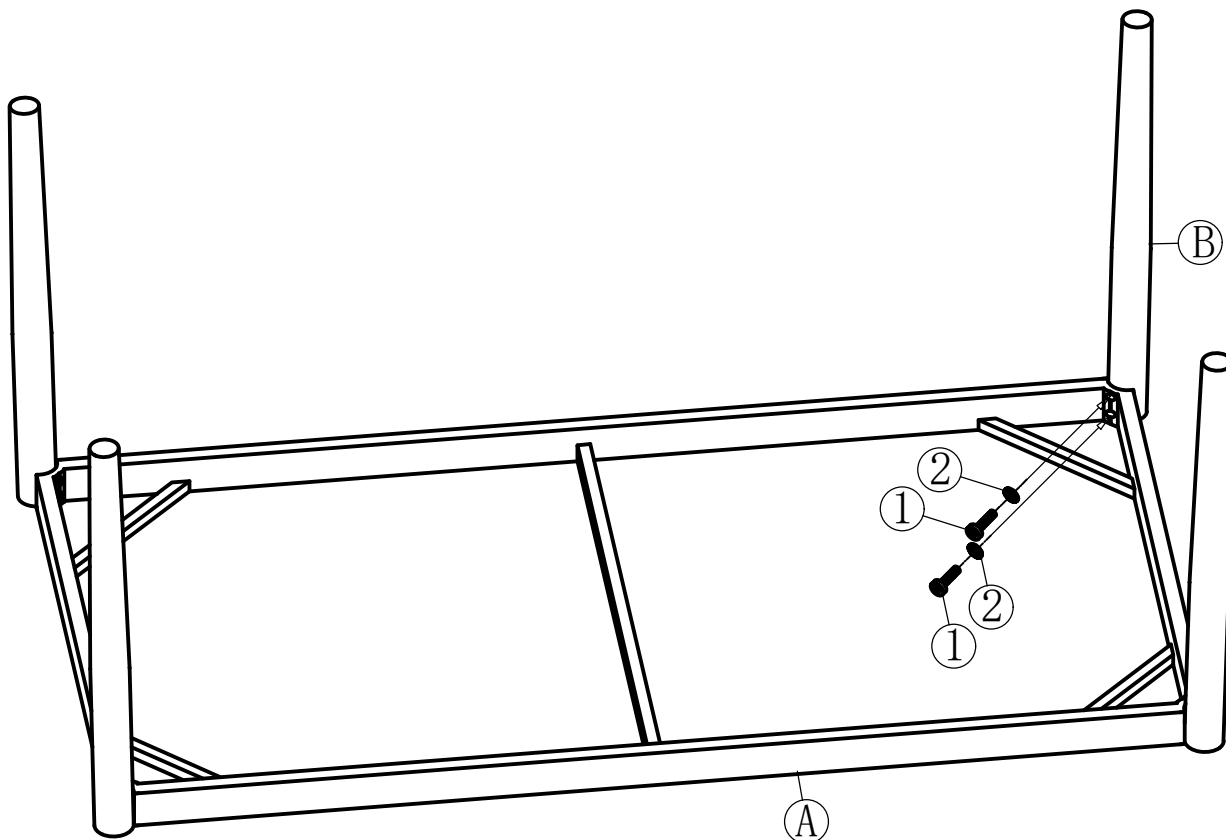

A	1
B	4
①	8
②	8

2

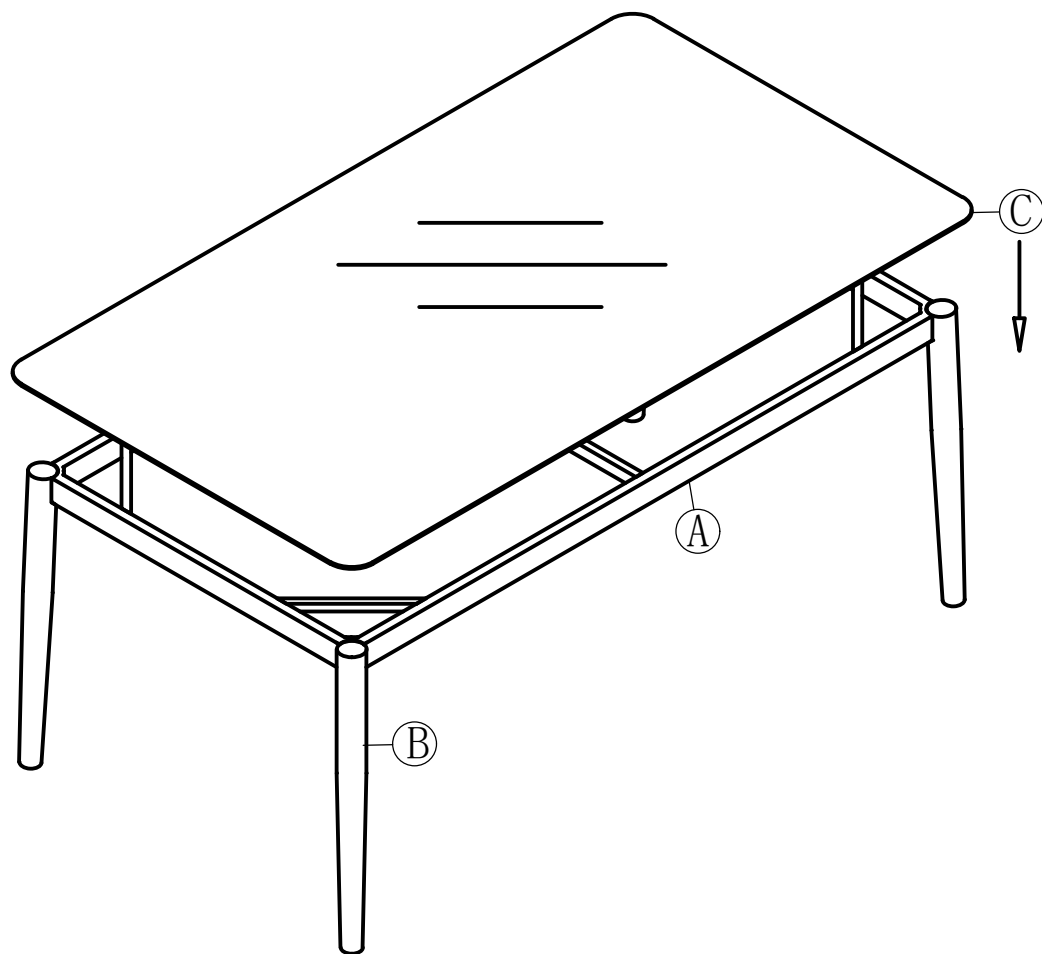

C	1
---	---

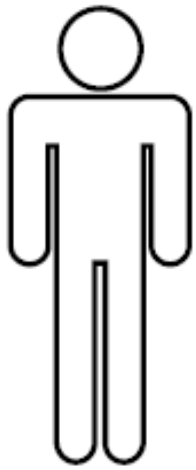

max: 110 Kg