

Modellname:
Nazwa modelu:

Nature Plus

Modellreihe:
Numer modelu: **1205FF02**

Type: **02**
Typ:

Blatt Nr
Strona **1** von: **8**
z:



- D** Montageanleitung
- NL** Handleiding voor de montage
- TR** Montaj talimati
- GB** Assembly instructions
- PL** Instrukcja montażu
- RU** Инструкция по монтажу

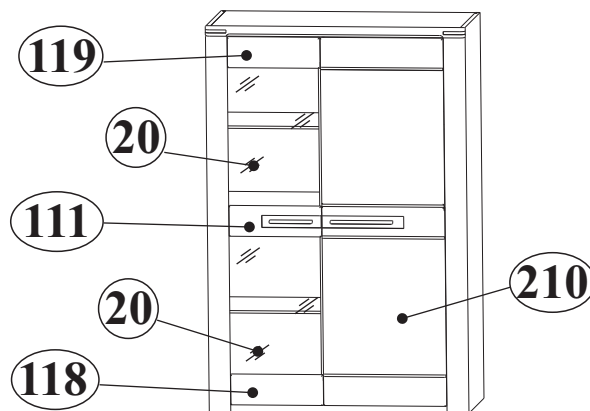
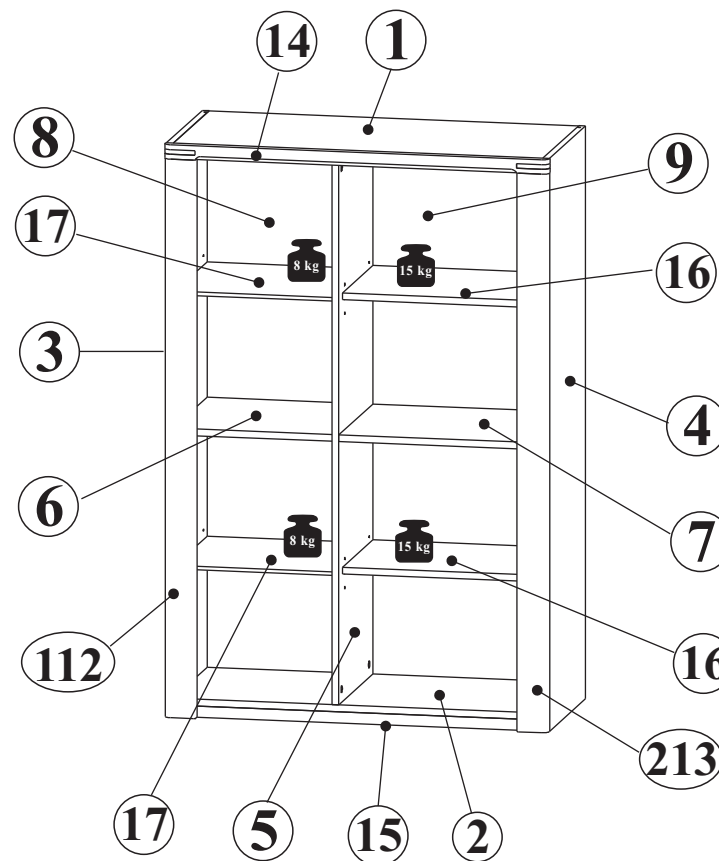
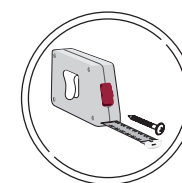
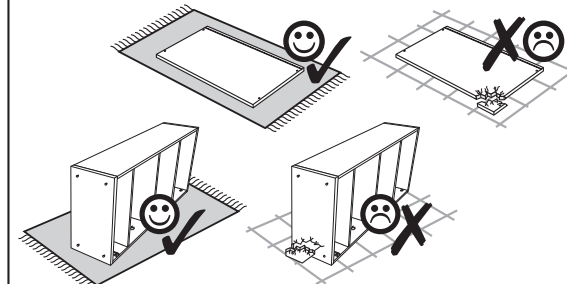
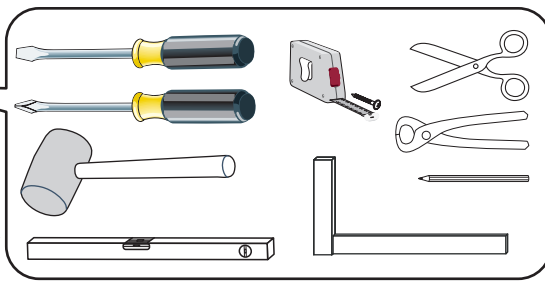
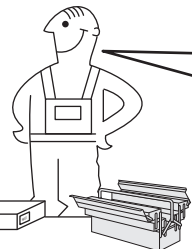
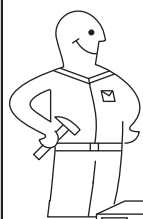
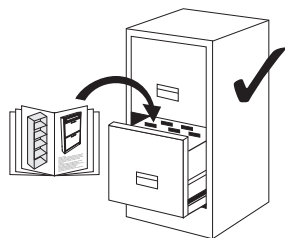

Modellname: **Nature Plus**
Nazwa modelu:

Modellreihe: **1205FF02**
Numer modelu:

Type: **02**
Typ:

Blatt Nr **2** von: **8**
Strona **2** z:

D	Bitte nur mit einem Staubtuch oder leicht feuchtem Lappen reinigen. Keine scheuernden Putzmittel verwenden.
GB	Please only clean with a duster or a damp cloth. Do not use any abrasive cleaners.
NL	Reinig alleen met een stofdoek of een lichtjes vochtige doek. Gebruik geen schurende poetsmiddelen.
PL	Czyszczenie należy wykonać wyłącznie za pomocą ściereczki lub lekko nawilżonego ręcznika. Nie stosować środków czyszczących do szorowania.
TR	Lütfen sadece bir toz bezilye veya hafif nemli yumuşak bir bezle siliniz. Aşındırıcı temizlik malzemeleri kullanmayınız.
RU	Очищайте от пыли тряпкой или слегка влажной ветошью. Не допускается применение чистящих средств, не предназначенных для ухода за мебелью.

D	Stoßen Sie nicht mit harten Gegenständen an die Glasflächen oder -kanten.
GB	Do not bump glass surfaces or edges with hard objects.
NL	Stoot niet met harde voorwerpen tegen de glazen oppervlakken of randen.
PL	Nie uderzać twardymi przedmiotami w szklane powierzchnie i krawędzie.
TR	Cam yüzeylere veya cam kenarlara sert cisimlerle temas etmemeye dikkat ediniz.
RU	Не допускайте ударов твердыми предметами по стеклянным поверхностям или по их краям.

D	Ziehen Sie alle Schrauben sowie tragende Verbindungsteile nach ca. 5 Wochen nach, um eine dauerhafte Standsicherheit zu gewährleisten.
GB	After approx. 5 weeks, tighten all screws and load-bearing connecting parts to ensure permanent stability.
NL	Draai alle schroeven en ook dragende verbindingstukken na ca. 5 weken nog eens vast, zodat een continue stabiliteit wordt gegarandeerd.
PL	Aby zagwarantować trwałą stabilność mocowania należy po ok. 5 tygodniach dokręcić wszystkie śruby oraz elementy łączeniowe.
TR	Tüm vida ve taşıyıcı bağlantı parçalarını kalıcı bir duruş güvenliğini sağlamak için yaklaşık 5 hafta sonra tekrar sıkınız.
RU	Подкрутите все болты, а также несущие соединительные детали прикл. через 5 недель для обеспечения устойчивости в течение длительного времени.

D	Schützen Sie Ihre Möbel generell vor Wasser (z.B. beim Wischen oder Blumen gießen). Die Feuchtigkeit kann in das Möbelstück eindringen und es beschädigen.
GB	In general, keep water away from your furniture (e. g. when mopping or watering plants). The moisture may penetrate the furniture and damage it.
NL	Bescherm uw meubelen doorgaans tegen water (bijv. bij het dweilen of als u de bloemen water geeft). De vochtigheid kan in het meubelstuk dringen en het beschadigen.
PL	Mebel należy chronić przed wodą (np. podczas czyszczenia lub podlewania kwiatków). Wilgoć może wnikać w mebel i uszkodzić go.
TR	Genelde mobilyalannızı sudan koruyunuz (ömeğin, yerleri paspaslarken veya çiçekleri sularken). Nem, mobilya parçasına nüfuz edebilir ve zarar verebilir.
RU	Предохраняйте мебель от попадания воды (например, при вытирании или поливке цветов). Не допускайте попадания влаги на мебель, чтобы предотвратить ее повреждение.

D	Das beigefügte Wandbefestigungsmaterial (Dübel und Schrauben) eignet sich nur für festes Mauerwerk (z.B. Beton- oder Ziegelwände). Für andere Wandaufbauten sind eventuell Spezialdübel und andere Schrauben notwendig. Ziehen Sie gegebenenfalls eine Fachkraft zurate.
GB	The enclosed wall mounting materials (dowels and screws) are only suitable for solid masonry (e. g. concrete or brick walls). Special dowels and other screws may be necessary for other wall constructions. If necessary, please consult a qualified professional.
NL	Het bijgeleverde bevestigingsmateriaal (pluggen en schroeven) is geschikt voor vaste muren (bijv. betonnen of bakstenen muren). Voor andere muurconstructies zijn eventueel speciale pluggen en andere schroeven noodzakelijk. Consulteer eventueel een vakman.
PL	Załączony materiał mocowania w ścianach (kołki oraz śruby) nadaje się wyłącznie do zastosowania w stabilnym murze (np. ściany betonowe lub ceglane). Do montażu ściennych innego rodzaju konieczne są specjalne kołki i inne śruby. W przypadku wątpliwości prosimy zasięgnąć porady fachowca.
TR	Teslimat kapsamındaki duvar tipi sabitleme materyali (dübel ve vidalar) sadece beton ve tuğla duvarlar gibi sağlam duvar yapıları için uygundur. Başka duvar yapıları için özel dübeller veya başka vidalar gerekli olabilir. Gerekirse bir uzmandan yardım alınız.
RU	Входящий в комплект поставки материал для крепления на стене (дюбели и болты) предназначен только для прочных каменных стен (например, бетонных или кирпичных). Для других типов стен используйте по мере необходимости специальные дюбели и другие болты. По мере необходимости обратитесь за помощью к специалистам.

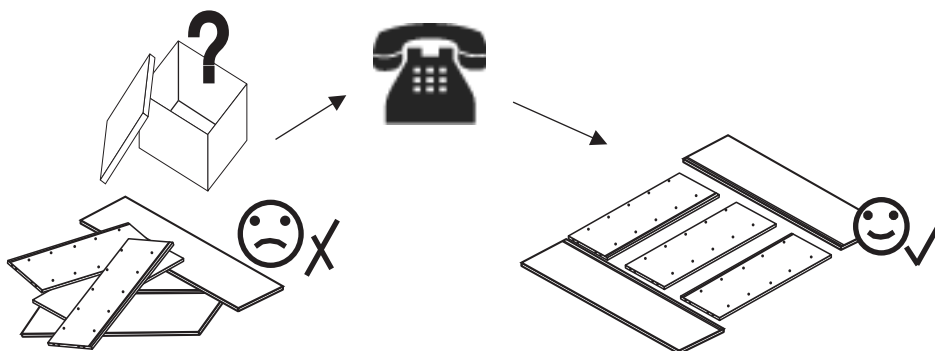

Modellname:
Nazwa modelu:

Nature Plus

Modellreihe:
Numer modelu:

1205FF02

Type: **02**
Typ:

Blatt Nr **3** von: **8**
Strona z:

Nr1

B1  ϕ 8x28 x20

B20  ϕ 8x50 x2

M1  x31

T1  x27

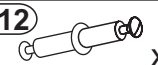
T12  x2

C2  x27

W2  x8

W1  x8

F15  x8

Ar1  x2

Ar2  x1

S3  3,5x13 x2

Nr2

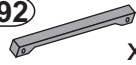
Sw92  x1

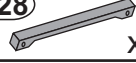
Sw28  x1

A2  M4x22 x4

Nr8

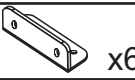
F12  x6

P13  3,5x13 x24

Nr3

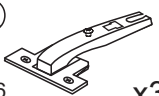
SR  ϕ 26 x3

D5  H-6 x3

E3  6,3x13 x6

S8  4x13 x6

Nr9

P16  4x16 x8

G4  x8

Nr4

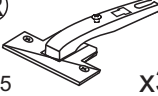
YR  ϕ 35 x3

D7  H4 x3

E3  6,3x13 x6

S8  4x13 x6

Nr5

J23  x12

F1  x8

P3  3,5x18 x24

Nr6

P13  3,5x13 x2

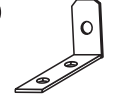
J11  x1

Nr7

Z3S  x2

O21  x1

<http://www.innostyle-mvg.de>



BG
CS
DA
DE
ET
EL
EN
ES
FR
FI
HR
HU
IT
LV
LT
NL
PL
PT
RO
SK
SL
SV

Bulgarisch
Tschechisch
Dänisch
Deutsch
Estnisch
Griechisch
Englisch
Spanisch
Französisch
Finnisch
Kroatisch
Ungarisch
Italienisch
Lettisch
Litauisch
Niederländisch
Polnisch
Portugiesisch
Rumänisch
Slowakisch
Slowenisch
Schwedisch

български
čeština
Dansk
Deutsch
Eesti
ελληνικά
English
español
Français
suomalainen
hrvatski
magyar
Italiano
Latvijas
Lietuvos
Nederlands
Polski
português
român
slovenský
slovenščina
Svenska

innostyle
comfort edition

Möbelvertriebsgesellschaft mbH & Co. KG



874/2012



Modellname:
Nazwa modelu:

Nature Plus

Modellreihe:
Numer modelu:

1205FF02

Type:
Typ:

02

Blatt Nr
Strona

4

von:
z:

8

1

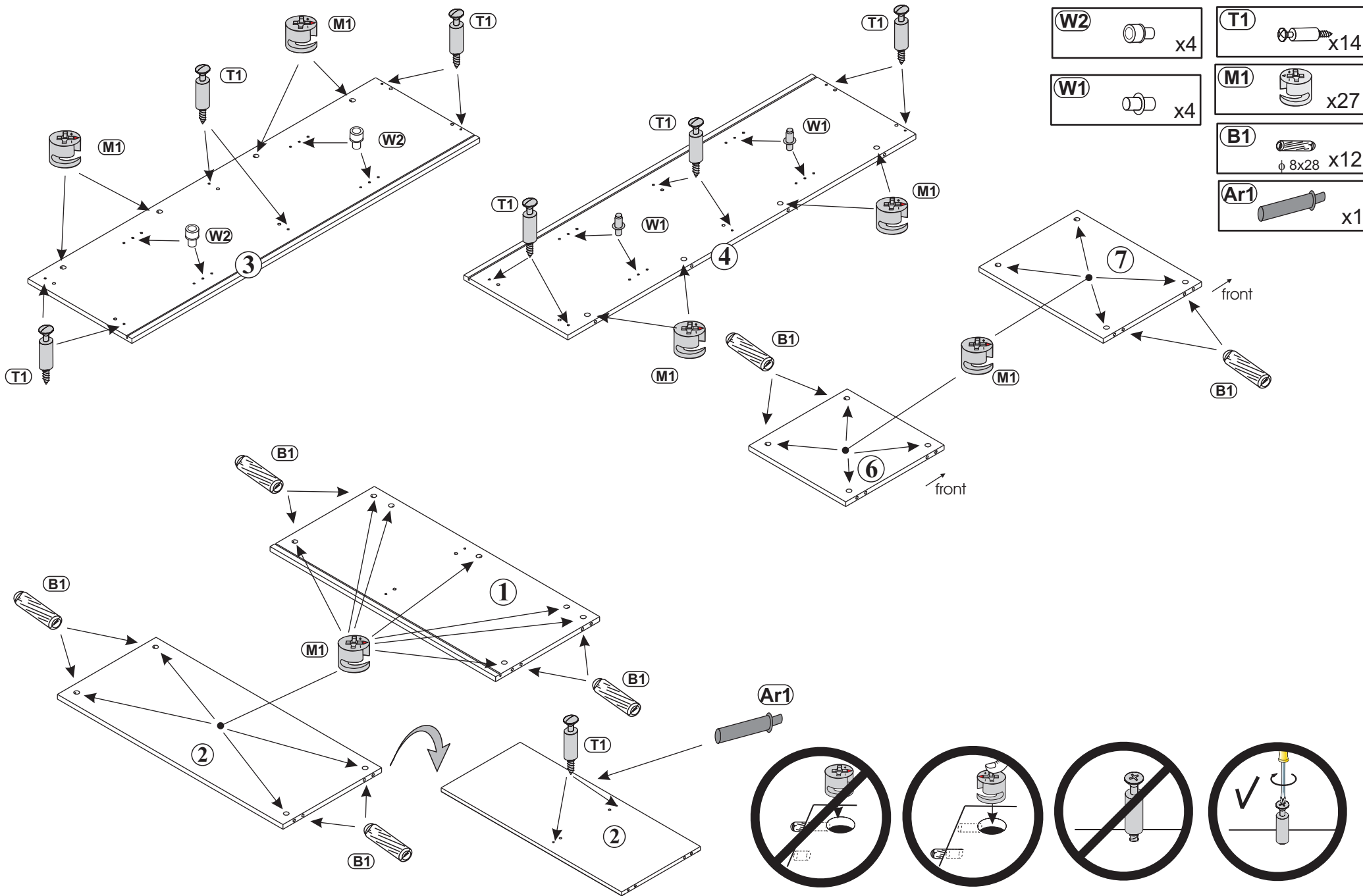

Modellname:
Nazwa modelu:

Nature Plus

Modellreihe:
Numer modelu:

1205FF02

Type:
Typ:

02

Blatt Nr
Strona

5

von:
z:

8

2

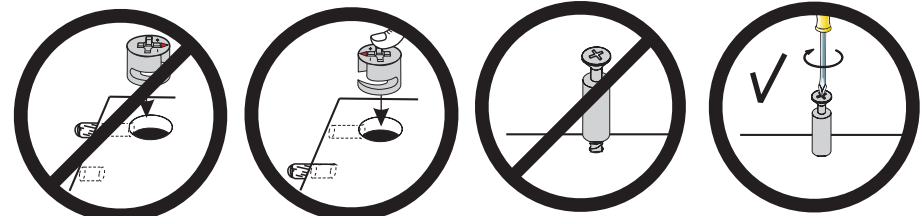
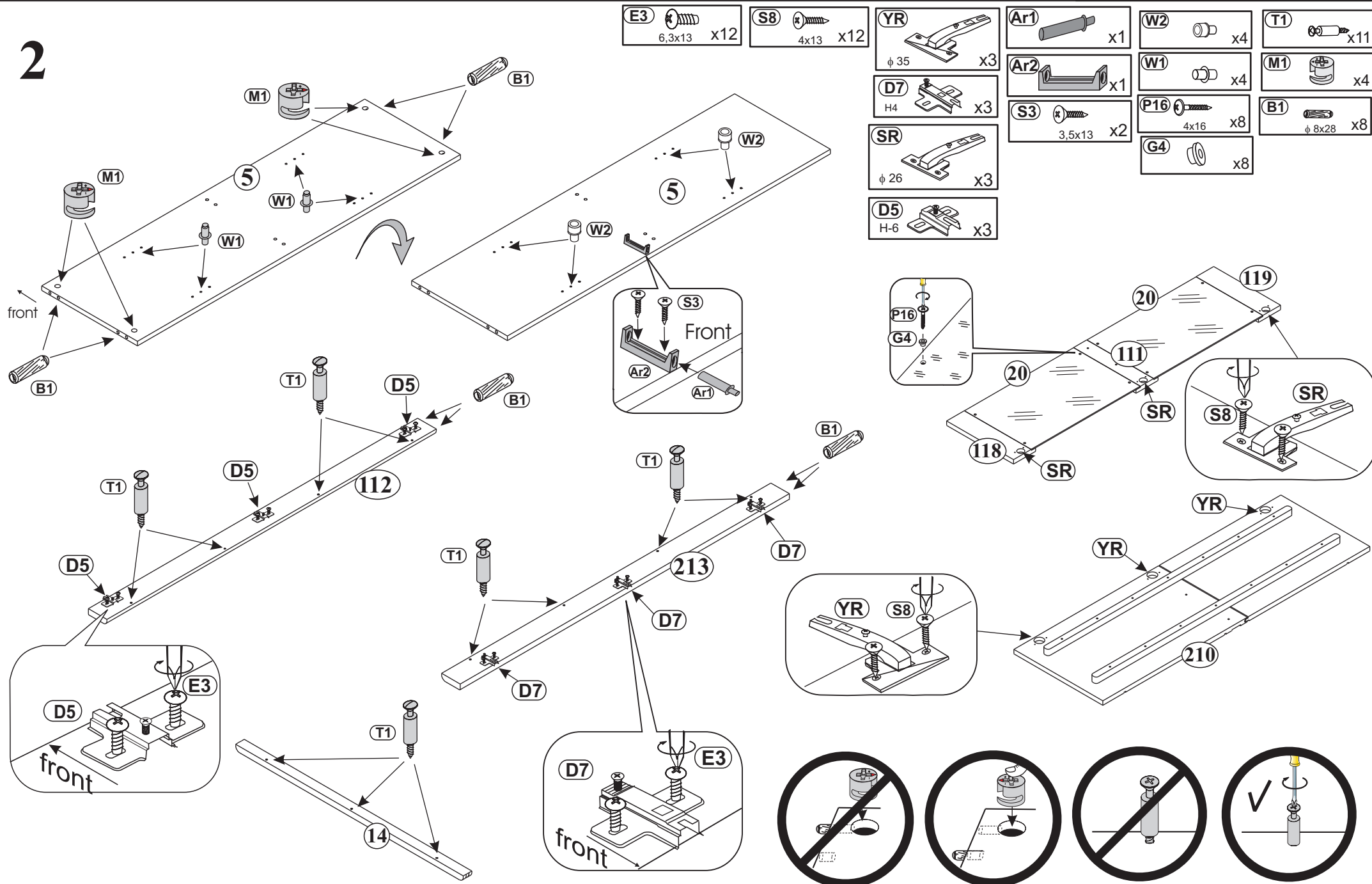

3

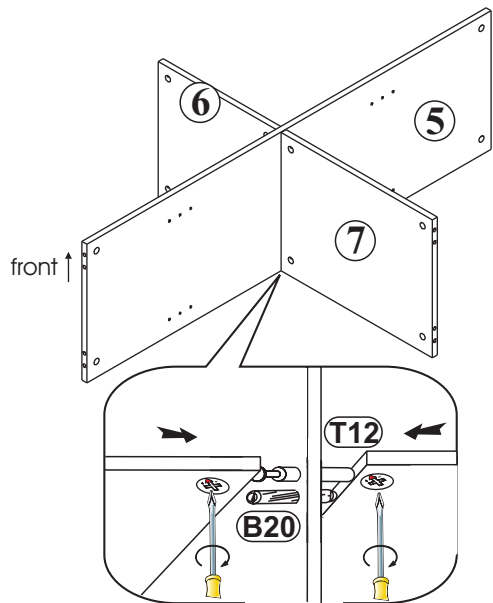
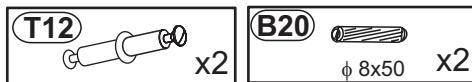

4

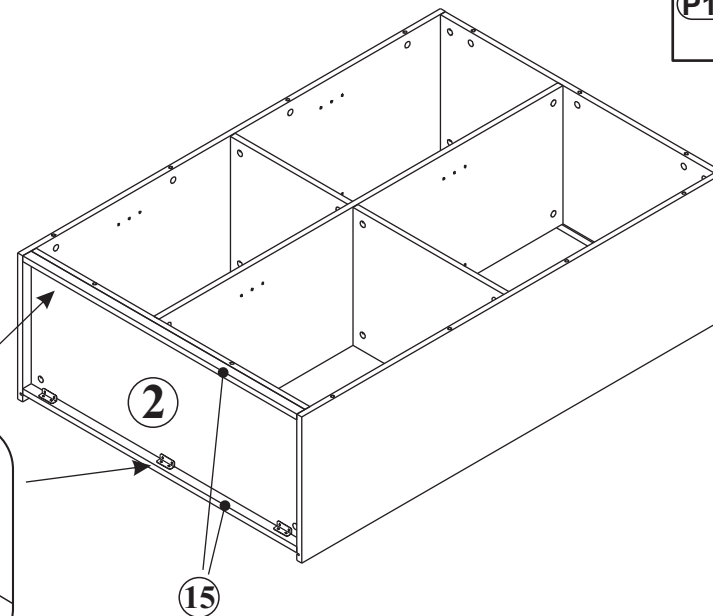
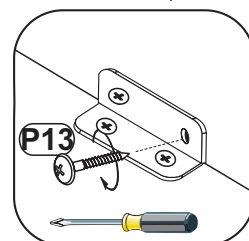
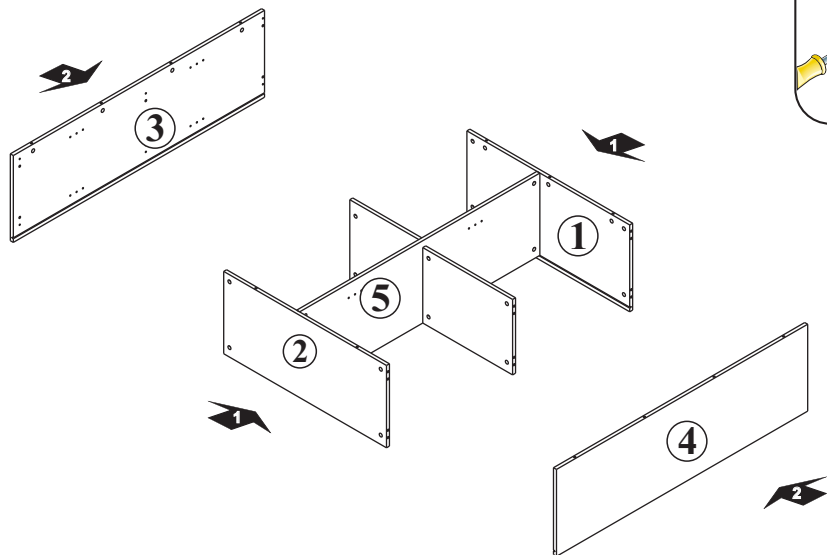
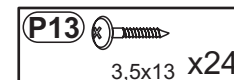
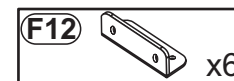
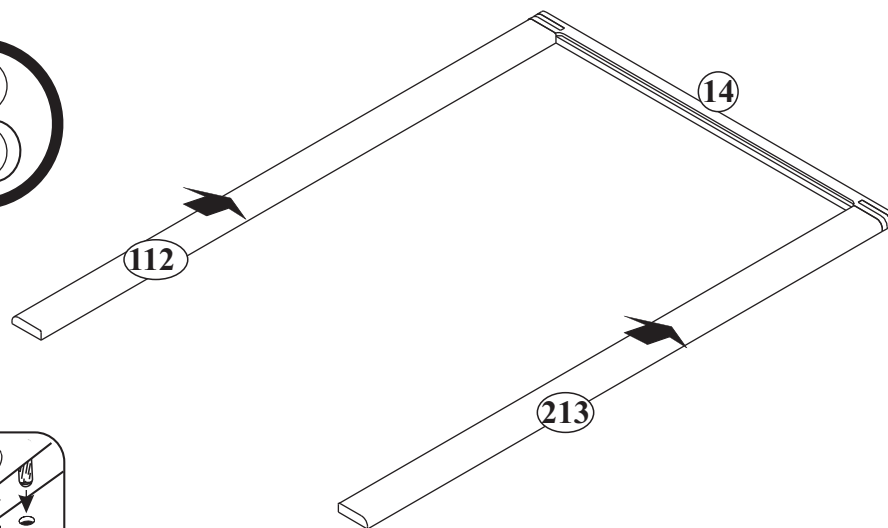
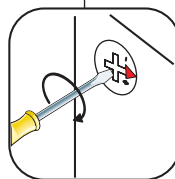
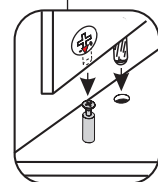
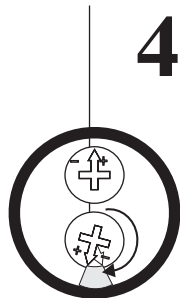

5

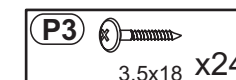
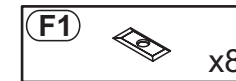
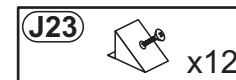
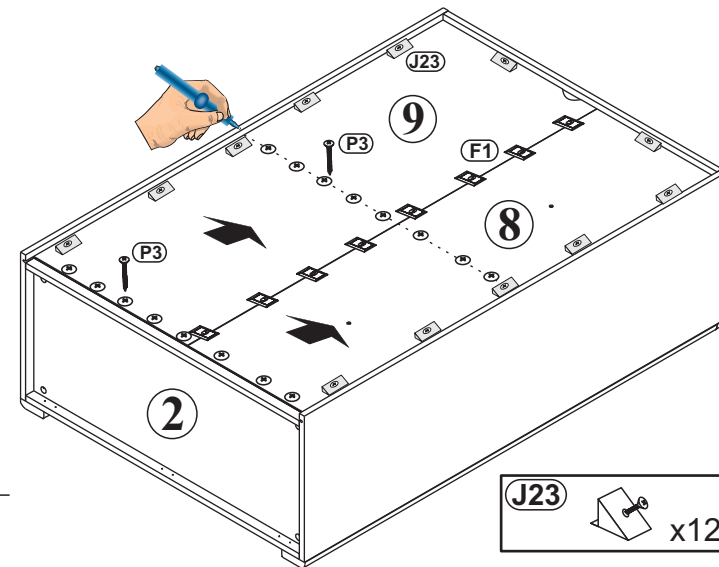
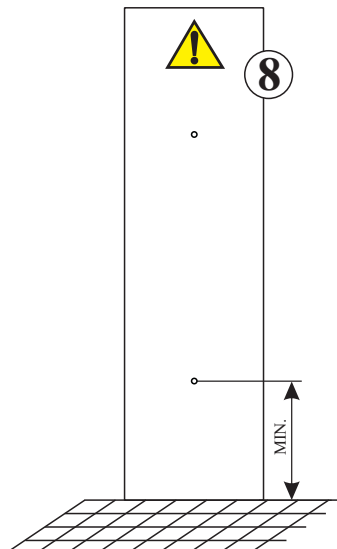
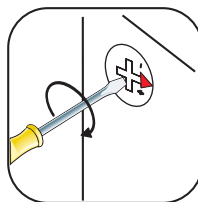
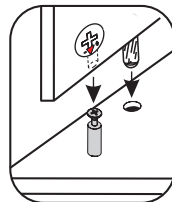
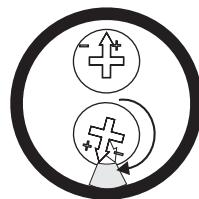
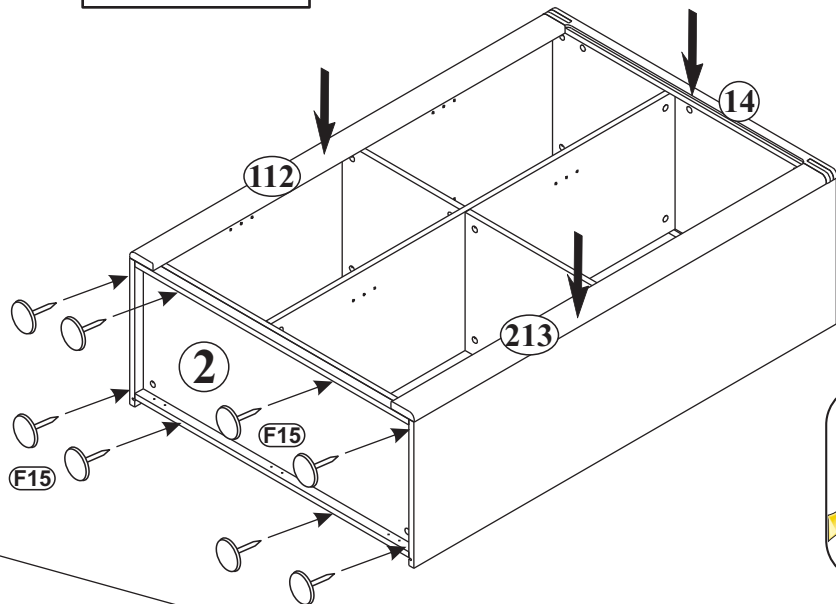
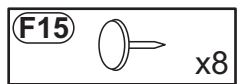

6

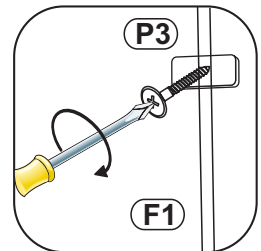
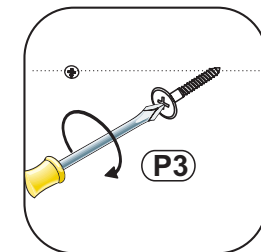
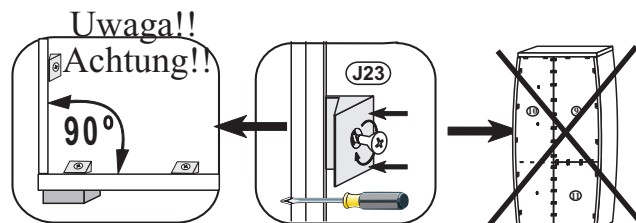
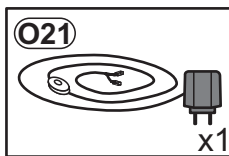
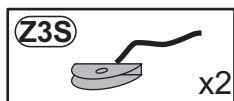
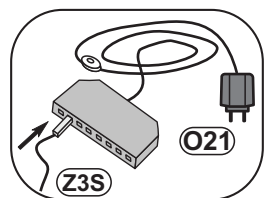
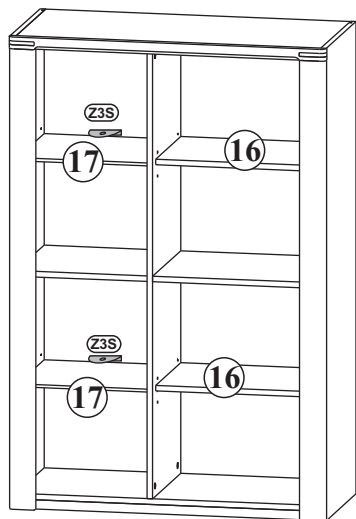

Modellname:
Nazwa modelu:

Nature Plus

Modellreihe:
Numer modelu:

1205FF02

Type:
Typ:

02

Blatt Nr
Strona

8

von:
z:

8

7

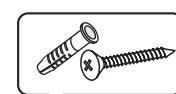
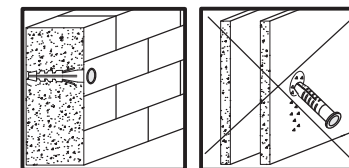
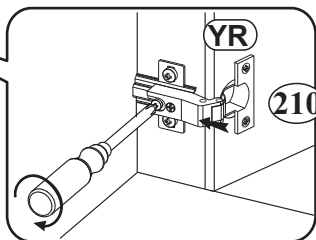
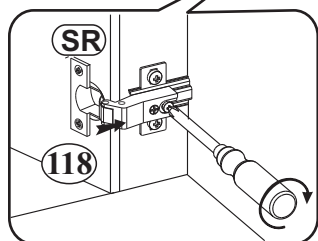
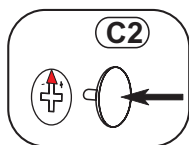
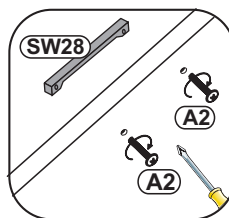
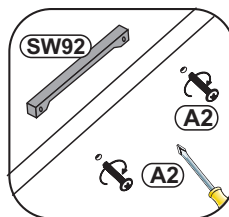
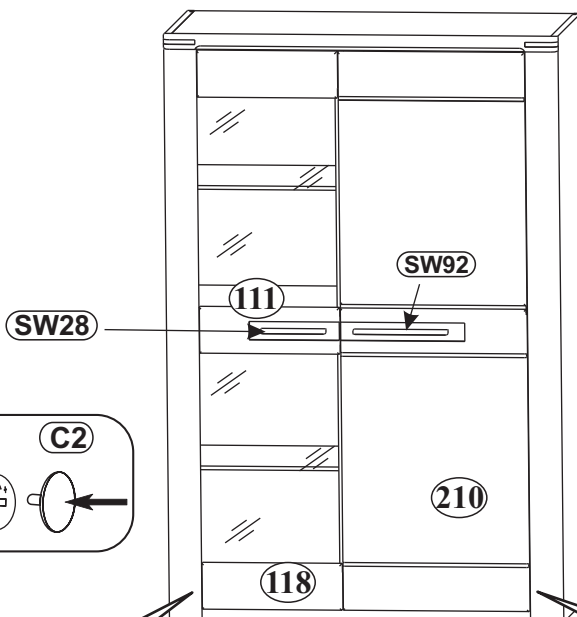
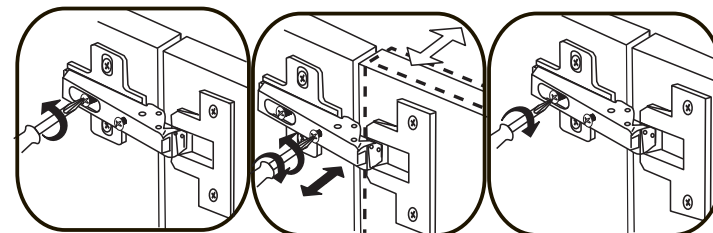
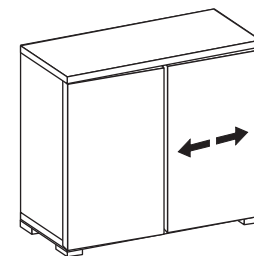
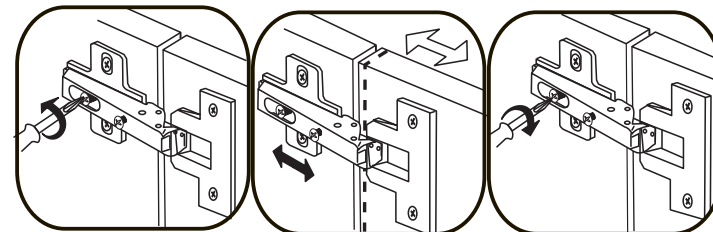
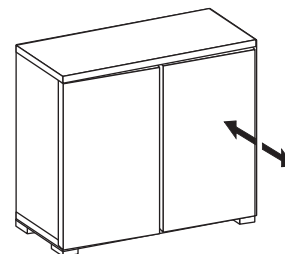
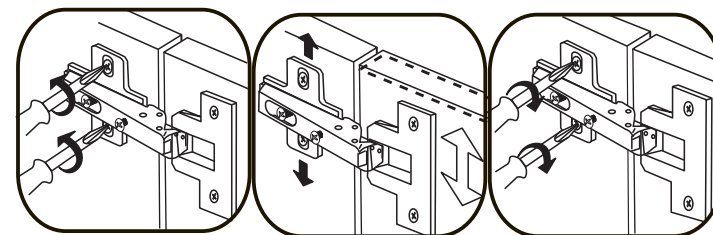
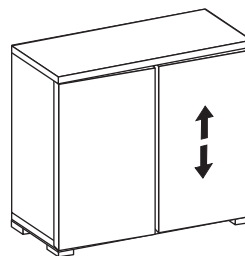
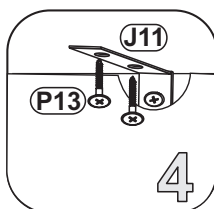
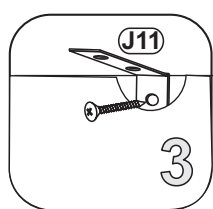
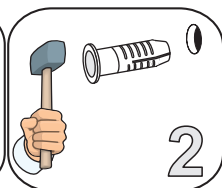
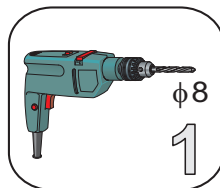
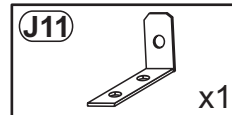
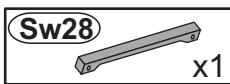
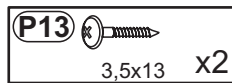
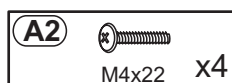

D CH AT LI LU Kleinstele und Verpackungsfolien bei der Möbelmontage von Kindern fernhalten!
GB US Keep small parts and plastic film out of the reach of children!
FR BE NC Tenir les petites pièces et les films plastiques hors de la portée des enfants!
NL Hou de kleine onderdelen en de plastic folie uit de buurt van kinderen!
IT Tenere i componenti di piccole dimensioni e le pellicole di plastica fuori dalla portata dei bambini!
SI Malhni delov i foliju za pakovanje folije pri montaži pohištna priane izven dosega otrok!
XS HR BA Malje dijelove i foliju za pakovanje priklom montaže namještaja držite dalje od djece
HU Bútorészeket közbden a kis alkatrészek és a csomagoló fóliák gyerekekkel távol tartandók!
BG Дребни детайли и опаковъчни фолия да се държат далеч от деца при монтажа на мебелите!
CZ SK Přední detaily i obalovací materiál při montáži nábytku držte dále od dětí
SE Vid möbelförpackningen ska smådelar och förpackningsfolien hållas oåtkomliga för barn!
RO Țineți departe de copil piesele mici și folia de ambalat la montarea mobilierului.
ES ¡Durante el montaje, mantenga alejados de los niños las piezas pequeñas y el material plástico de embalaje!

D CH AT LI LU Möbelmontage muss auf ebenerm Untergrund erfolgen. Bei Wandmontagen immer geeignetes Befestigungsmaterial verwenden.
GB US Furniture must be assembled on a flat surface. For assembly to the wall only use suitable fixing materials.
FR BE NC Le meuble doit être monté sur une surface plane. Pour le montage mural, utilisez des accessoires de fixation adaptés au type de mur.
NL De meubels dienen op een vlakke ondergrond te worden gemonteerd. Voor wandmontage moeten geschikte bevestigingsmaterialen worden gebruikt.
IT Il montaggio dei mobili deve avvenire su un fondo piano. Per il montaggio si prega di utilizzare solo materiali adatti.
SI Pohištvo je treba montirati na ravni podlagi. Pri stenski montaži vedno uporabite pritrilveni material.
XS HR BA Namještaj se mora montirati na ravnoj podlozi. Kod montaže na zid uvijek koristite prikladan materijal za pričvršćivanje.
HU A bútorcszerelési silk felületen kell végezni. Falra szereléshez mindig megfelelő rögzítianyagot kell használni.
BG Материалът на мебелите да се извършва на равна основа. При стенен монтаж винаги да се използва подходящ крепежен материал.
CZ SK Montáž nábytku provádějte na rovném podkladu. Při montáži na stěnu používejte vždy vhodný příslušovací materiál.
SE Monteringen av möbelen måste göras på jämnt underlag. Vid väggmontering ska lämpligt uppfästingsmaterial användas.
RO Montarea mobilier trebuie să se realizeze pe o pardoseală dreaptă. La montarea la perete utilizați întotdeauna material de fixare adecvat.
ES El montaje debe efectuarse sobre una superficie uniforme. En el montaje mural emplee siempre el material de fijación adecuado.

D CH AT LI LU Bitte beachten Sie die Montageanleitung. Halten Sie immer die angegebene Wattzahl ein. Verhindern Sie einen Hitzestau.
GB US Please observe the assembly instructions. Do not exceed the max. given wattage. Ensure that the heat is not allowed to build up.
FR BE NC Veuillez respecter la notice de montage. Respectez impérativement le nombre des watts maximal. Veillez à éviter toute accumulation de chaleur.
NL Lees a.u.b. de montagehandleiding door. Hou de beslist aan het max. opgegeven wattage. Zorg ervoor dat geen hittehuwling onstaat.
IT Attenersi alle istruzioni di montaggio. Rispettarsi rigorosamente il numero di watt max. indicato. Assicurarsi che non si verifichi un accumolo di calore.
SI Upoštevajte navodila za montažo. Vedno upoštevajte navedeno število vatov. Preprečite zastoj vročine.
XS HR BA Obratite pažnju! Vas pozor na uputu za montažu. Uvijek se pridržavajte navedenog broja vat. Izbjegavajte zastoj vrućine.
HU Vegye figyelembe a szerelési útmutatót. Mindig tartsa be a megadott wattszámot. Akadályozza meg a hőelődést.
BG Моля, вземете под внимание ръководството за монтаж. Спазвайте винаги посочените ватове. Избягвайте акумулиране на топлина.
CZ SK Dodržujte prosím návod k montáži. Vždy dodržujte uvedenou hodnotu výkonu (watt). Zabráňte tak přehřívání.
SE Följ monteringsanvisningen. Följ alltid angivet watttal. Undvik att hetta uppstår.
RO Respectați instrucțiunile de montaj. Respectați întotdeauna numărul de watt impus. Evitați acumularea de căldură.
ES Le rogamos que tenga presente las instrucciones de montaje. Respete siempre el número indicado de vatios. Evite la acumulación de calor.

D CH AT LI LU Halten Sie die max. zulässigen Belastungswerte der Möbelteile ein. Details siehe Montageanleitung
GB US Comply with the max. permissible loads. For details, please refer to the assembly instructions
FR BE NC Respectez les valeurs de charge max. admissibles des parties de meubles. Pour plus de détails, cf. la notice de
NL Hou de maximaal geoorloofde belastingwaarden van de meubeldelen aan. Voor details verwijzen wij naar de montagehandleiding
IT Rispettare la portata max. permessa degli elementi del mobile. Per dettagli si vedano le istruzioni di montaggio e si vada
SI Upoštevajte največjo dovoljeno obremenitev delov pohištna. Podrobnosti najdete v navodilih za montažo in na
XS HR BA Tartsa be a bútorelemek max. megengedett terhelési értékét. A részleteket lásd a szerelési útmutatóban
HU Snaazajite makc. dopustimite strojnosti na natovarvanje na mebelite. Za podrobnosti vjvj ръководството за монтаж
BG Додръжте max. prípustnê hodnoty zátizení nábykových dílů. Podrobnosti viz návod k montáži
CZ SK Dodržujte max. přípustnê hodnoty zátizení nábykových dílů. Podrobnosti viz návod k montáži
SE Följ max. tillåten belastning av möbeldelarna. Mer information finns i monteringsanvisningen
RO Respectați valorile de solicitare max. admise pentru corpurile de mobilier. Pentru detalii consultați instrucțiunile de montaj
ES Respete los valores máximos de carga admisibles para las piezas de los muebles. Consulte los detalles en las instrucciones

D CH AT LI LU Zur Möbelfeinigung ein mit Wasser befeuchtetes, fusselfreies Baumwolltuch verwenden. Geeignigte Flächen immer trockenreiben!
GB US To clean the furniture only use a water dampened lint-free cotton cloth. Once cleaned, always wipe the surfaces dry.
FR BE NC Utilisez un chiffon en coton non pelucheux humidifié avec de l'eau pour nettoyer les meubles. Séchez systématiquement les surfaces
NL nettooyes en les frottant!
IT Gebrauk een met water bevochtigde, pluistvrije katoenen doek om de meubels te reinigen. Wrijf gereinigde oppervlakken altijd droog!
SI Per pulire il mobile utilizzare un panno di cotone inumidito d'acqua e che non perde pelucchi. Asciugare sempre le superfici che si sono
XS HR BA upuše!
HU Za čišćenje pohištva uporabljajte vlažno bombažno krpo, ki ne pušča vlaken. Očišćene površine vedno obrišite do suhine!
BG За čišćenje namještaja koristite sa vodom navlaženpu pamučnu krpu koja ne ispušta vlakna. Očišćene površine uvijek obrišite suhom krpom!
CZ SK Bútorisztáshoz vizzel benedvesített, nem szárlázódó pamukkenőt használjon. A megtisztított felületeket mindig törője szárazra!
SE För möbelförpackning används en luddfrit bomullsduk fuktad med vatten. Rengörda ytor ska alltid torkas torra!
RO Pentru curățarea mobilierului utilizați o lavetă din bumbac fără scame umezită cu apă. Suprafețele curățate se șterg întotdeauna până se usucă!
ES Emplee un paño de algodón humedecido con agua y libre de pelusa para la limpieza de los muebles. ¡Seque siempre las superficies que ha limpiado!