



GOEBEL

Ø 4,8 mm

SW = 8 mm

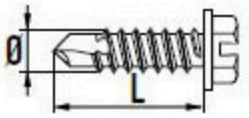

UPM/RPM/TR-MIN = max. 1200

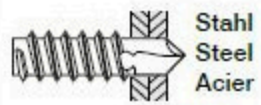
		
4,8 x 16 mm	2 x 1,0 mm	max. 4,4 mm
4,8 x 19 mm	2 x 1,0 mm	max. 4,4 mm
4,8 x 25 mm	2 x 1,0 mm	max. 4,4 mm

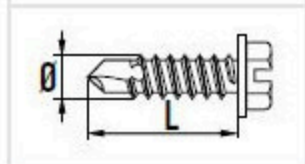

4,8 x 16 mm
4,8 x 19 mm
4,8 x 25 mm



	CODE	P	D		CODE	P	D		CODE
	40661 48160	2,0 mm	10,0 mm		40622 48160	3,0 mm	12,0 mm		40624 48160
	40661 48190	2,0 mm	10,0 mm		40622 48190	3,0 mm	12,0 mm		40624 48190
	40661 48250	2,0 mm	10,0 mm		40622 48250	3,0 mm	12,0 mm		40624 48250