

ULTIMEA

FULL HD PROJECTOR USER MANUAL

Apollo P40

Model No.: U0320



THE EXPERIENCE YOU CRAVE

Contents

01 FULL HD Projector User Manual

English

10 Bedienungsanleitung für den FULL HD Beamer

Deutsch

19 Manual de usuario para el proyector FULL HD

Español

28 Manuel d'utilisateur du projecteur FULL HD

Français

37 Manuale d'uso per il proiettore FULL HD

Italiano

WE ARE READY TO HELP



support@ultimea.com

Prefer video tutorial?

Setup guidance video and User Manuals on ULTIMEA website.



support.ultimea.com



@Ultimea_Official  +1 888-598-8875 (US) Mon-Fri 9am-5pm (PST)
+49 89-628-25828 (EU) Mon-Fri 9am-5pm (CET)

IMPORTANT: Before using the projector, make sure you read these instructions and the safety instructions in the online User Manual. Your product may differ from the illustrations on this sheet, but the instructions are the same.

Note: Due to HDCP protocol, Netflix, Amazon Prime and similar services can not be played by the projector wirelessly. Please use a Fire TV stick, Roku stick or Chromecast TM (not included) and connect it to the projector to use their streaming services.

1 Accessories List



Apollo P40



Remote
(Batteries not included)



Quick guide



AV Cable



Cable HD



Power Cable

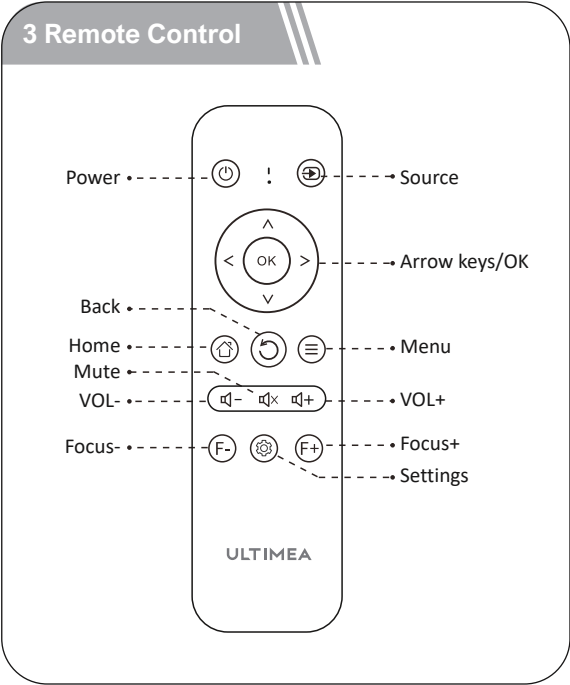
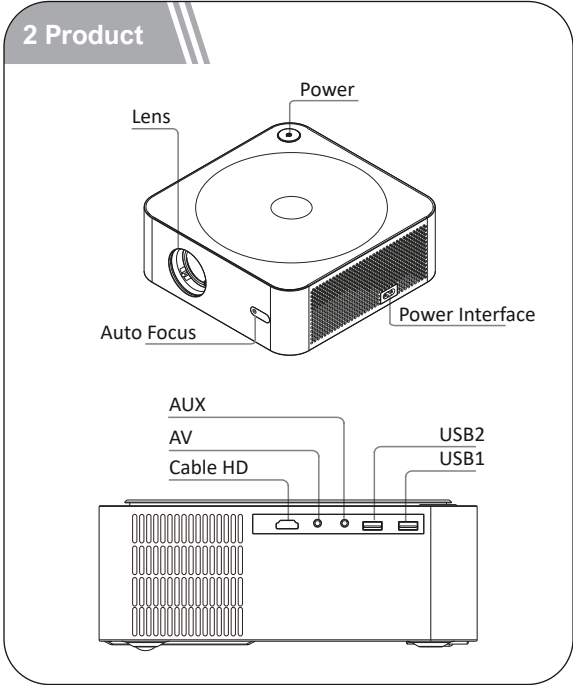

4 Quick Setup

4.1 Power On / Power Off

Plug in the AC power cord, click the power button on the operation panel of the machine or on the remote control and the projector will start to work.

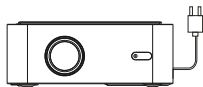

4.2 Projector Installation

You can choose horizontal placement or hanger installation.

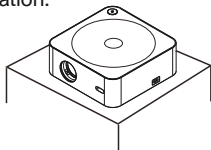

Horizontal placement

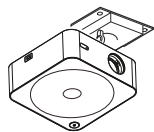

Hanger installation

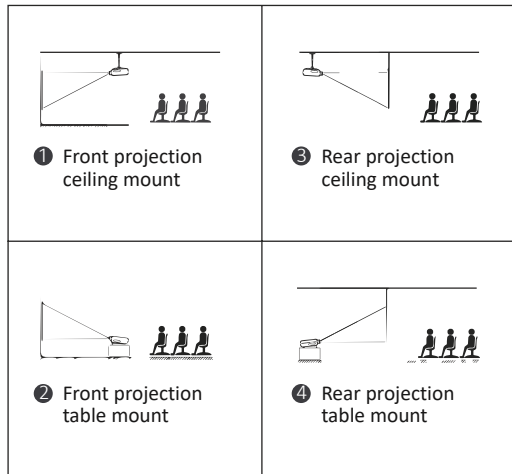

The projection screen can be played from 35" to 150".
 The recommended projection screen is 50" to 100".
 Ambient darkness will improve the clarity of the projected images.

4.3 Adjust the Image Projected On the Screen

Check the horizontal and vertical settings of the screen.

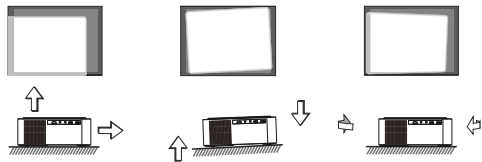

4.4 WiFi Settings

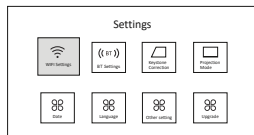

1. Click the settings icon on the homepage to enter the projector settings.

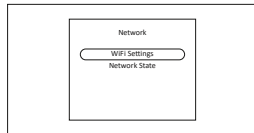

2. Select "WiFi" and click "OK" to confirm.

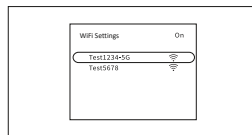

3. The network list will appear after searching for the network. Select the wireless network that needs to be connected and press the "OK" button to confirm.

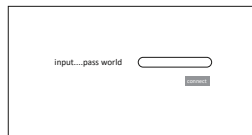

4. Click the connect button after entering the password.

4.5 BT Settings

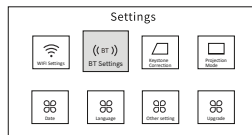

1. Click the settings icon on the homepage to enter the to projector settings, select the "BT" click "OK" button to confirm.

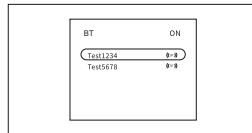

2. Turn on BT and select the BT signal that needs to be connected.

5 Screen Mirroring

For iOS Device

1. Move the projector cursor to AirPlay on the homepage, select AirPlay and click the "OK" button.

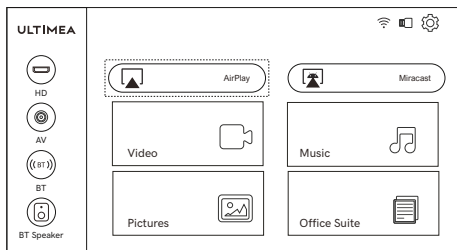

Note: Make sure that the projector and mobile phone are connected to the same network.

2. The operation steps of the mobile phone are as follows: No setting is required on the projector.

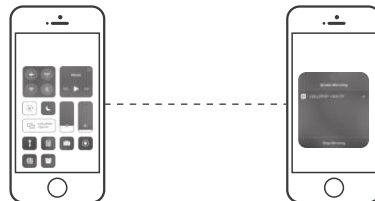

- Step 1 : Open the Control Center and tap the Screen Mirroring on your iOS device.
- Step 2 : Select the device U0320 to be cast from the searched devices.

For Android Device

1. Move the projector cursor to Miracast on the homepage, select Miracast and click the "OK" button.

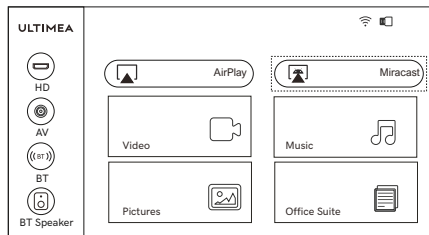

2. Turn on the Android device, enter phone settings to find "Device Connectivity", click on "Wireless Display", search for U0320 of the projector and select U0320. Make sure that the projector and Android device are connected to the same network.

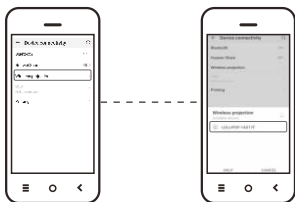

Note:

Due to HDCP protocol, Netflix, Amazon Prime and similar services can not be played by the projector wirelessly. Please use a Fire TV stick, Roku stick or Chromecast TM (not included) and it connect to the projector to use their streaming services.

6 Wired Connection to Devices

Fire TV Stick

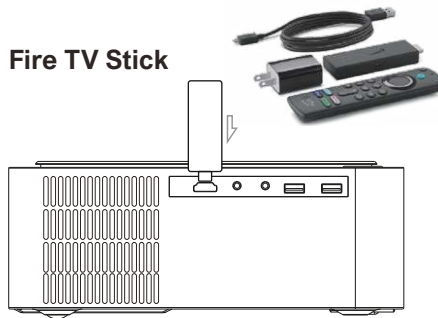

How to connect the Fire TV stick to the projector:

1. Connect the TV stick to power using the USB cable.
 2. Plug the stick to the HD port on the projector.
 3. Select the HD option in the settings on the projector.
- The content of the Fire TV stick will be displayed on the projection screen. Use the Fire stick's remote to select and stream your content.

6.1 HD Channel

Use an HD cable to connect the projector with a computer, game console, set-top box and other devices that support HD output and select HD option in settings.

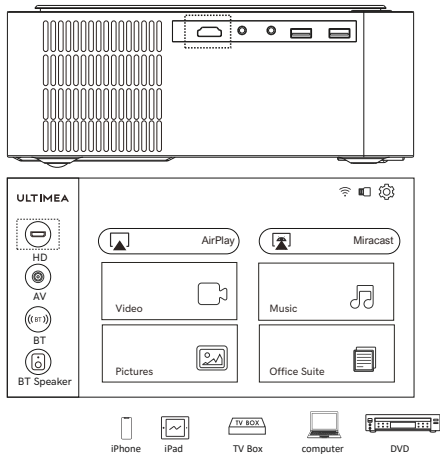

Note: Due to type-C protocols, android device can not be played by HD cable connection.

6.2 AV Channel

Use an AV cable to connect the projector with a DVD player, set-top box and other devices that support AV output .

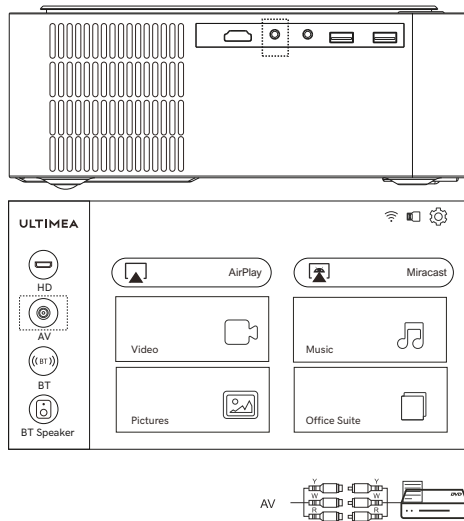

6.3 Multimedia Channel

After inserting the USB, select the movie, music, pictures or office file according to the type of file you need to play and enter the corresponding playback menu.

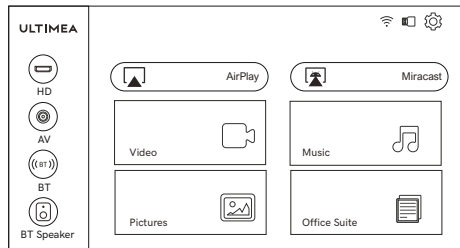
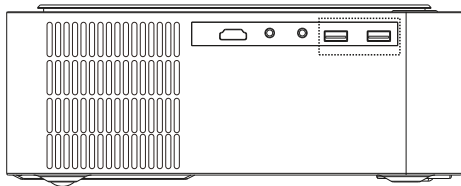

7 BT Speaker Mode

Turn on the projector and enter the homepage, use the remote control to select the BT speaker and press the "OK" button. The display will show BT speaker mode and enter 'waiting to pair'. You can connect to the projector (Name: BT-U0320) through the BT settings of the mobile device.

To use the projector function, press the return button to exit BT speaker mode. Now the machine will turn on and enter projector mode.

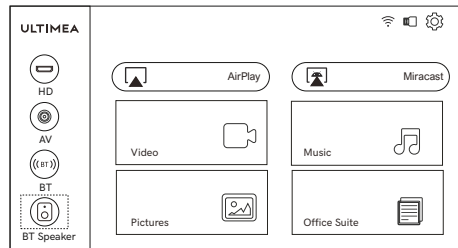

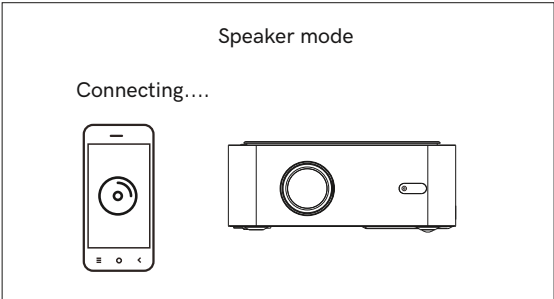

Enjoy your new projector!

WIR SIND BEREIT ZU HILFEN



support@ultimea.com

Bevorzugen Sie Video-Tutorials?

Einrichtungsvideos und
Benutzerhandbücher auf der
ULTIMEA-Website.



support.ultimea.com



@Ultimea_Official

+1 888-598-8875 (US) Mon-Fri 9am-5pm (PST)
+49 89-628-25828 (EU) Mon-Fri 9am-5pm (CET)

WICHTIG: Bevor Sie den Beamer in Betrieb nehmen, lesen Sie bitte unbedingt diese Anleitung und die Sicherheitshinweise im Online-Benutzerhandbuch. Ihr Produkt kann sich von den Abbildungen auf diesem Blatt unterscheiden, aber die Anweisungen sind die gleichen.

Hinweis:

Aufgrund des HDCP-Protokolls können Netflix, Amazon Prime und ähnliche Dienste nicht drahtlos über den Beamer wiedergegeben werden. Bitte verwenden Sie einen Fire TV-Stick, Roku-Stick oder Chromecast TM (nicht im Lieferumfang enthalten) und schließen Sie ihn an den Projektor an, um deren Streaming-Dienste zu nutzen.

1 Zubehör



Apollo P40



Fernbedienung
(Batterien nicht enthalten)



Kurzanleitung



AV Kable



HD Kable



Netzkabel

2 Produkt

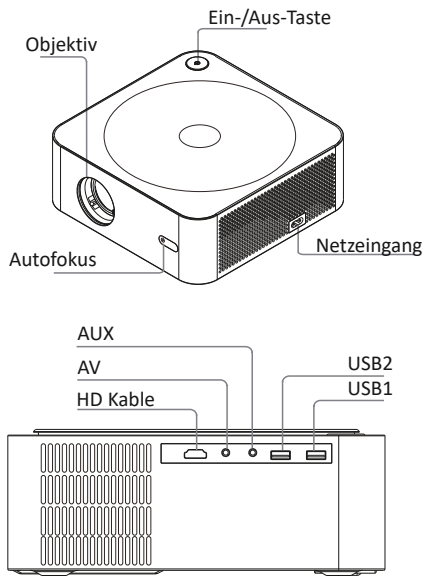

3 Fernbedienung

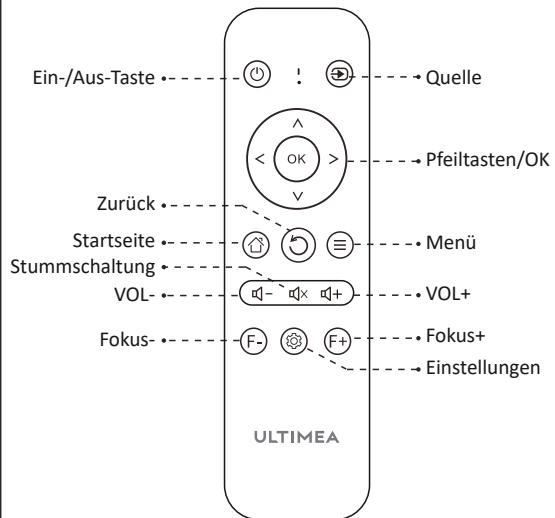

4 Kurzanleitung

4.1 Einschalten/Ausschalten

Schließen Sie das Netzkabel an, drücken Sie die Einschalttaste auf dem Bedienfeld des Geräts oder auf der Fernbedienung und der Projektor beginnt zu arbeiten.

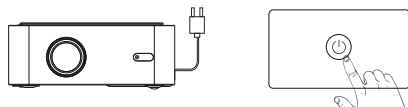

4.2 Aufstellung des Beamer

Sie können den Beamer entweder horizontal aufstellen oder aufhängen.

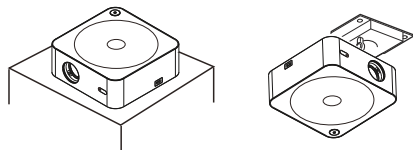

Horizontale Aufstellung Aufgehängte Installation

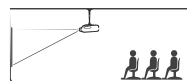

1 Deckenhalterung für Aufprojektion

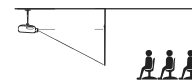

3 Rückprojektions-Deckenhalterung



2 Tischhalterung für Aufprojektion

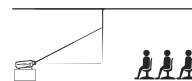

4 Rückprojektions-Tischhalterung

Die Projektionsfläche kann von 35" bis 150" bespielt werden. Die empfohlene Projektionsfläche beträgt 50" bis 100". Die Klarheit der projizierten Bilder wird durch die Dunkelheit der Umgebung verbessert.

4.3 Einstellen des auf die Leinwand projizierten Bildes

Überprüfen Sie die horizontalen und vertikalen Einstellungen des Bildschirms.

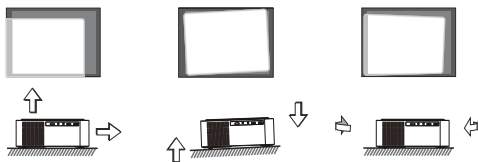

4.4 WLAN-Einstellung

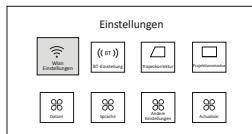

1. Klicken Sie auf das Einstellungssymbol auf der Startseite, um die Projektoreinstellungen aufzurufen.

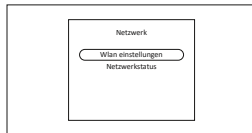

2. Wählen Sie "WiFi" und klicken Sie auf "OK" zur Bestätigung.

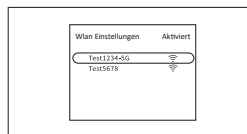

3. Die Netzwerkliste wird nach der Suche nach dem Netzwerk angezeigt. Wählen Sie das drahtlose Netzwerk aus, das verbunden werden soll, und bestätigen Sie mit der Taste "OK".



4. Klicken Sie auf die Schaltfläche "Connect", nachdem Sie das Passwort eingegeben haben.

4.5 BT-Einstellung

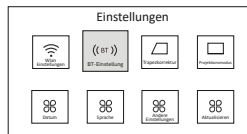

1. Klicken Sie auf das Einstellungssymbol auf der Startseite, um die Projektoreinstellungen aufzurufen, wählen Sie "BT" und bestätigen Sie mit "OK".

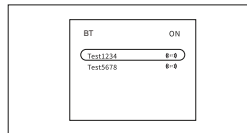

2. Schalten Sie BT ein und wählen Sie das BT-Signal, das verbunden werden soll.

5 Bildschirmspiegelung

Für iOS-Geräte

1. Bewegen Sie den Cursor des Projektors auf AirPlay auf der Startseite, wählen Sie AirPlay und klicken Sie auf die Schaltfläche "OK".

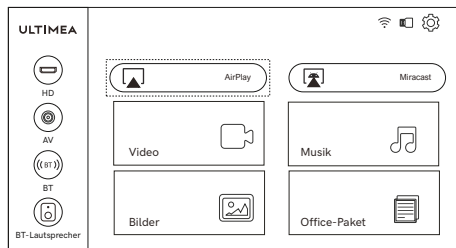

Hinweis: Stellen Sie sicher, dass der Projektor und das Mobiltelefon mit demselben Netzwerk verbunden sind.

2. Die Schritte zur Bedienung des Mobiltelefons sind wie folgt: Am Projektor ist keine Einstellung erforderlich.

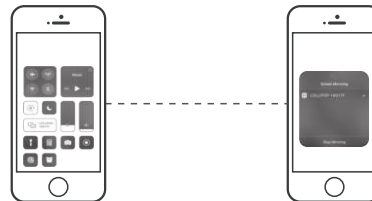

Schritt 1:
Öffnen Sie das Kontrollzentrum und tippen Sie auf Screen Mirroring auf Ihrem iOS-Gerät.

Schritt 2:
Wählen Sie das zu übertragende Gerät U0320 aus den gesuchten Geräten.

Für Android-Geräte

1. Bewegen Sie den Cursor des Projektors auf Miracast auf der Startseite, wählen Sie Miracast und klicken Sie auf die Schaltfläche "OK".

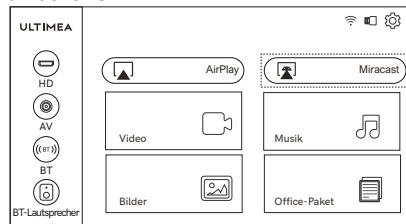

2. Schalten Sie das Android-Gerät ein, gehen Sie in die Telefoneinstellungen, um "Device Connectivity" zu finden, klicken Sie auf "Wireless Display", suchen Sie nach U0320 des Beamer und wählen Sie U0320. Stellen Sie sicher, dass der Projektor und das Android-Gerät mit demselben Netzwerk verbunden sind.

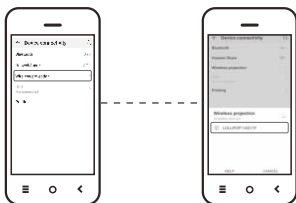

Anmerkung:

Aufgrund des HDCP-Protokolls können Netflix, Amazon Prime und ähnliche Dienste nicht über den Projektor drahtlos wiedergegeben werden. Bitte verwenden Sie einen Fire TV-Stick, Roku-Stick oder Chromecast TM (nicht im Lieferumfang enthalten) und verbinden Sie ihn mit dem Projektor, um deren Streaming-Dienste zu nutzen.

6 Kabelgebundene Verbindung

Fire TV Stick

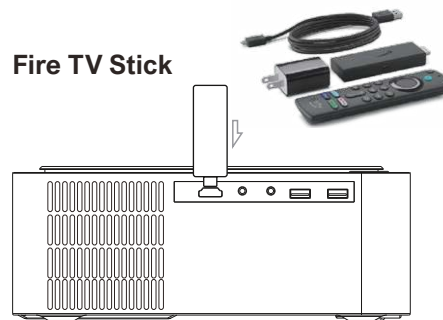

Wie wird der Fire TV-Stick an den Beamer angeschlossen?

1. Schließen Sie den TV-Stick mit dem USB-Kabel an das Stromnetz an.
2. Schließen Sie den Stick an den HD-Anschluss des Beamer an.
3. Wählen Sie die HD-Option in den Einstellungen des Beamer. Der Inhalt des Fire TV-Sticks wird auf der Projektionsfläche angezeigt. Verwenden Sie die Fernbedienung des Fire Sticks, um Ihre Inhalte auszuwählen und zu streamen.

6.1 HD-Kanal

Verwenden Sie ein HD-Kabel, um den Projektor mit einem Computer, einer Spielekonsole, einer Set-Top-Box und anderen Geräten zu verbinden, die eine HD-Ausgabe unterstützen, und wählen Sie die HD-Option in den Einstellungen.

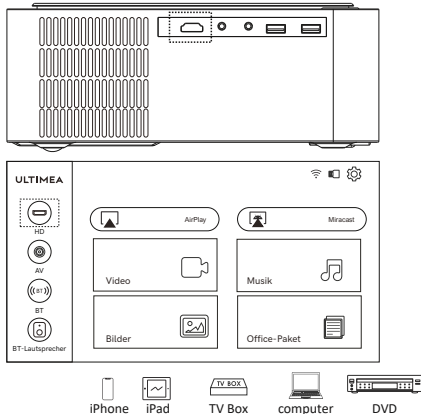

Hinweis: Aufgrund von Typ-C-Protokollen können Android-Geräte nicht über eine HD-Kabelverbindung abgespielt werden.

6.2 AV-Kanal

Verwenden Sie ein AV-Kabel, um den Projektor mit einem DVD-Player, einer Set-Top-Box und anderen Geräten zu verbinden, die einen AV-Ausgang unterstützen.

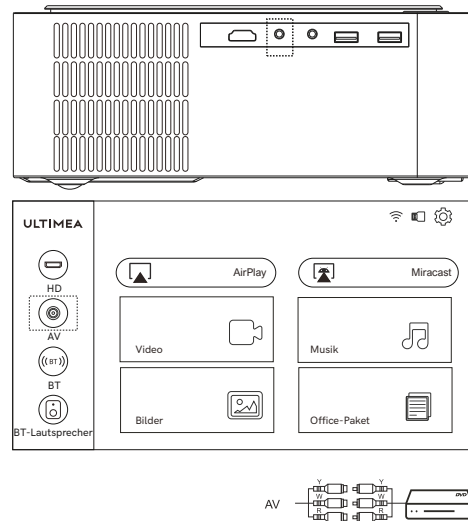

6.3 Multimedia-Kanal

Wählen Sie nach dem Einstecken des USB-Kabels die Film-, Musik-, Bild- oder Office-Datei, die Sie abspielen möchten, und rufen Sie das entsprechende Wiedergabemenü auf.

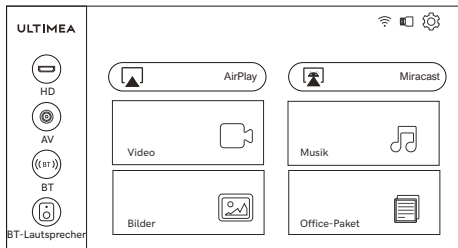
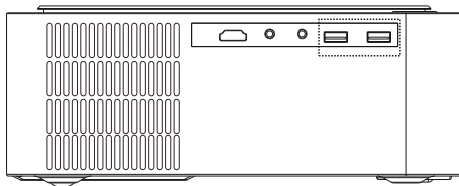

7 BT-Lautsprechermodus

Schalten Sie den Projektor ein und rufen Sie die Homepage auf, wählen Sie mit der Fernbedienung den BT-Lautsprecher aus und drücken Sie die Taste "OK". Auf dem Display wird der BT-Lautsprechermodus angezeigt und die Meldung "waiting to pair" erscheint. Sie können die Verbindung zum Projektor (Modell: U0320) über die BT-Einstellungen des Mobilgeräts herstellen.

Um die Projektorfunktion zu nutzen, drücken Sie die Return-Taste, um den BT-Lautsprechermodus zu beenden. Jetzt schaltet sich das Gerät ein und wechselt in den Projektor-Modus.

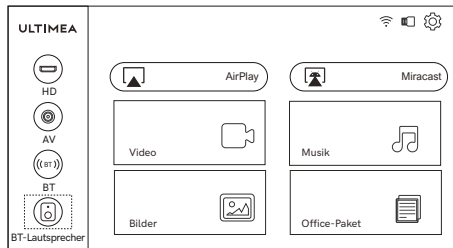

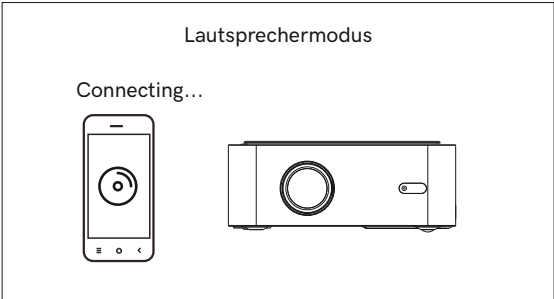

Viel Spaß mit Ihrem neuen Beamer!

ESTAMOS LISTOS PARA AYUDARTE



support@ultimea.com

¿Prefiere un video tutorial?

La Guía de configuración en video y Manuales de Usuario disponibles en el sitio web de ULTIMEA.



support.ultimea.com



@Ultimea_Official  +1 888-598-8875 (US) Mon-Fri 9am-5pm (PST)
+49 89-628-25828 (EU) Mon-Fri 9am-5pm (CET)

IMPORTANTE: Antes de usar el proyector, asegúrese de haber leído éstas instrucciones y las instrucciones de seguridad en el Manual de Usuario en línea. Su producto puede diferir de las ilustraciones de esta hoja, pero las instrucciones son las mismas.

Nota: Debido al protocolo HDCP, Netflix, Amazon Prime y servicios similares no pueden ser reproducidos por el proyector de forma inalámbrica. Por favor use un Fire TV stick, Roku stick o Chromecast TM (no incluidos) y conéctelo al proyector para usar sus servicios de streaming.

1 Lista de Accesorios



Apollo P40



Control Remoto
(Baterías no incluidas)



Guía Rápida



Cable AV



Cable HD



Cable de poder

2 Producto

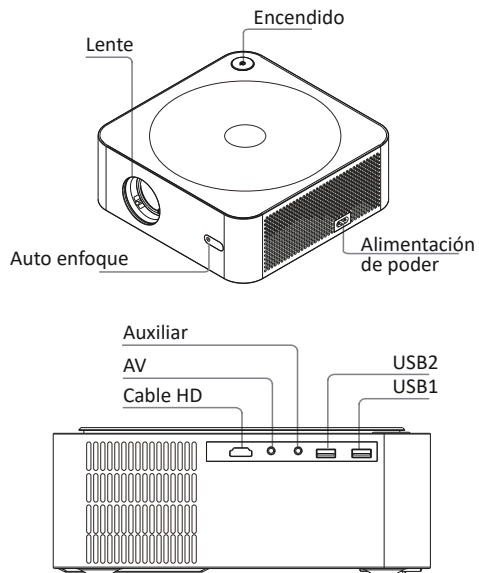

3 Control Remoto

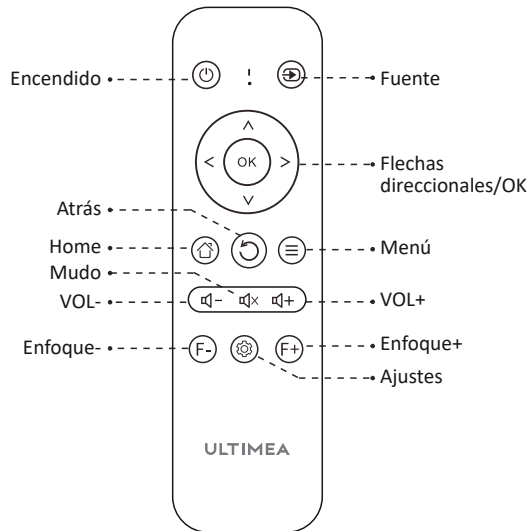

4 Configuración Rápida

4.1 Encendido / Apagado

Conecte el cable de alimentación de poder, presione el botón de encendido en el panel de operación de la máquina o en el control remoto para que el proyector comience a funcionar.

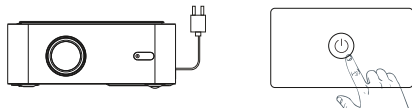

4.2 Instalación del proyector

Puede elegir entre la posición horizontal o la instalación suspendida.

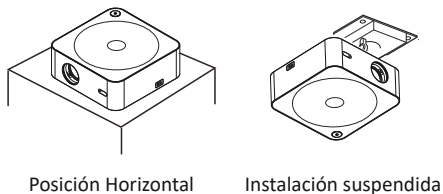

Posición Horizontal

Instalación suspendida

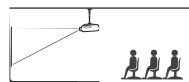

1 Proyección frontal sobre techo

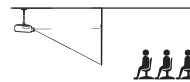

3 Retroproyección sobre techo



2 Proyección frontal sobre mesa

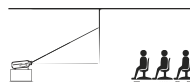

4 Retroproyección sobre mesa

La pantalla de proyección se puede reproducir desde 35" hasta 150".

La pantalla de proyección recomendada es de 50" a 100".

La oscuridad ambiental mejorará la claridad de las imágenes proyectadas.

4.3 Ajuste la imagen proyectada en la pantalla

Compruebe la configuración horizontal y vertical de la pantalla.

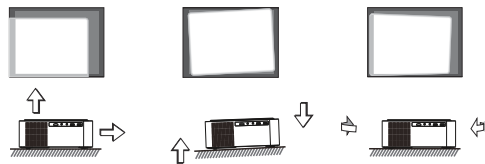

4.4 Configuración de WiFi

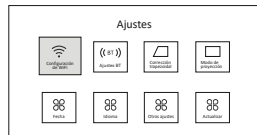

1. Haga clic en el icono de ajustes en la página de inicio para ingresar a los ajustes del proyector.



2. Seleccione "WiFi" y haga clic en "OK" para confirmar.

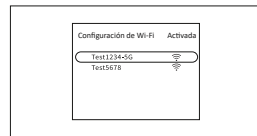

3. La lista de redes aparecerá después de buscar la red. Seleccione la red inalámbrica que necesita conectarse y presione el botón "OK" para confirmar.

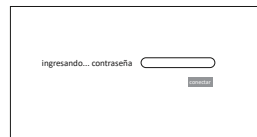

4. Haga clic en el botón de conectar después de ingresar la contraseña.

4.5 Ajustes BT

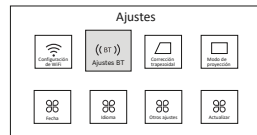

1. Haga clic en el icono de configuración en la página de inicio para ingresar a la configuración del proyector, seleccione "BT", haga clic en el botón "Aceptar" para confirmar.

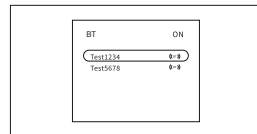

2. Active BT y seleccione la señal de BT que necesita conectarse.

5 Duplicar pantalla

Para dispositivos iOS

1. Mueva el cursor del proyector a AirPlay en la página de inicio, seleccione AirPlay y presione el botón "OK".

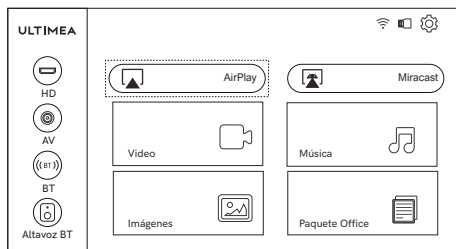

Nota: asegúrese de que el proyector y el teléfono móvil estén conectados a la misma red.

2. Los pasos de operación del móvil son los siguientes:
No se requiere configuración en el proyector.

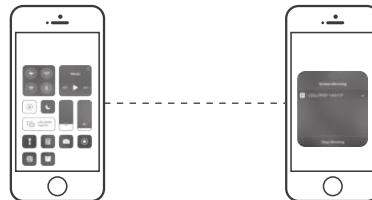

- Paso 1:
Abra el Centro de control y toque Duplicar Pantalla en su dispositivo iOS.

- Paso 2:
Seleccione el dispositivo U0320 para ser emitido de los dispositivos buscados.

Para Dispositivos Android

1. Mueva el cursor del proyector a Miracast en la página de inicio, seleccione Miracast y haga clic en el botón "OK".

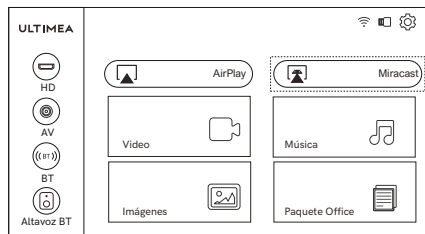

2. Encienda el dispositivo Android, ingrese la configuración del teléfono y seleccione "Conectividad del dispositivo", haga clic en "Pantalla Inalámbrica", busque Proyector U0320 y seleccione U0320. Asegúrese de que el proyector y el dispositivo Android están conectados a la misma red.

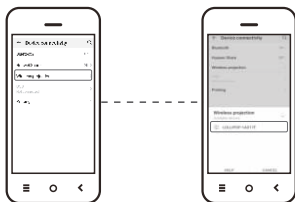

Nota:

Debido al control HDCP, Netflix, Amazon Prime y servicios similares no pueden ser reproducidos por el proyector de forma inalámbrica. Por favor use un Fire TV stick, Roku stick o Chromecast TM (no incluidos) y conéctelo al proyector para usar sus servicios de streaming.

6 Conexión por cable a dispositivos

Fire TV Stick

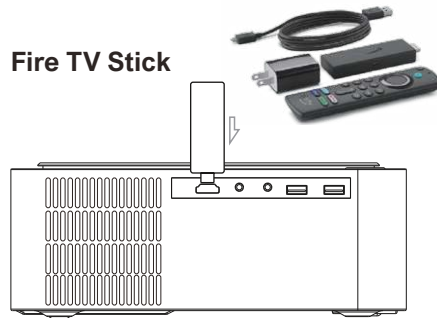

Cómo conectar el dispositivo Fire TV al proyector:

1. Conecte el dispositivo de TV a la alimentación mediante el cable USB.
2. Conecte el stick al puerto HD del proyector.
3. Seleccione la opción HD en la configuración del proyector. El contenido del dispositivo Fire TV se mostrará en la pantalla de proyección. Use el control remoto del Fire Stick para seleccionar y transmitir su contenido.

6.1 Canal HD

Use un cable HD para conectar el proyector con una computadora, consola de juegos, decodificador u otros dispositivos que admitan salida HD y seleccione la opción HD en la configuración.

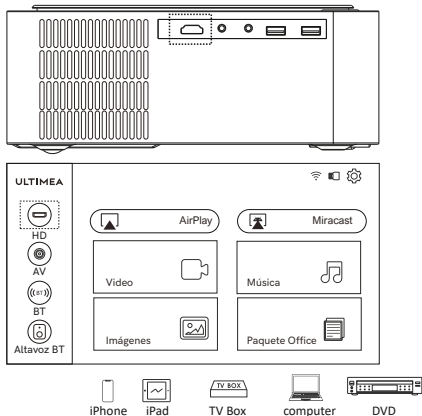

Note: Debido a los protocolos de tipo C, los dispositivos android no pueden ser reproducidos por una conexión por cable HD

6.2 Canal AV

Utilice un cable AV para conectar el proyector con un reproductor de DVD, decodificador y otros dispositivos compatibles con salida AV.

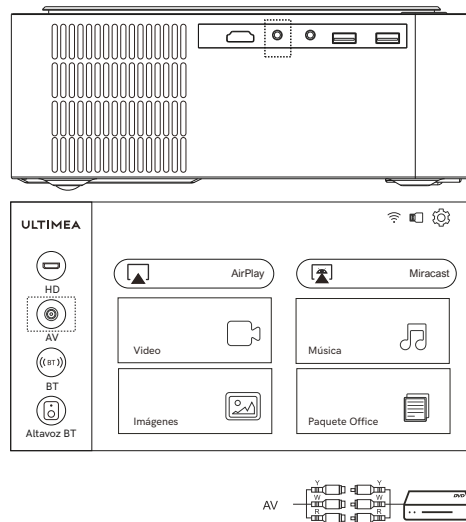

6.3 Canal Multimedia

Después de insertar el USB, seleccione la película, música, imágenes o el archivo office de acuerdo con el tipo de archivo que necesita reproducir e ingrese al menú de reproducción correspondiente.

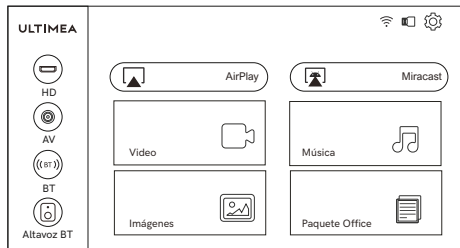
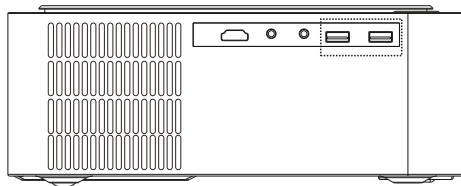

7 Modo Parlante BT

Encienda el proyector e ingrese a la página de inicio, use el control remoto para seleccionar el altavoz BT y presione el botón "OK". La pantalla mostrará el modo de altavoz BT e ingresará "esperando para emparejar". Puede conectarse al proyector (Nombre: U0320) a través de la configuración de BT del dispositivo móvil.

Para usar la función de proyector, presione el botón de retorno para salir del modo de altavoz BT. Ahora la máquina se encenderá y entrará en modo proyector.

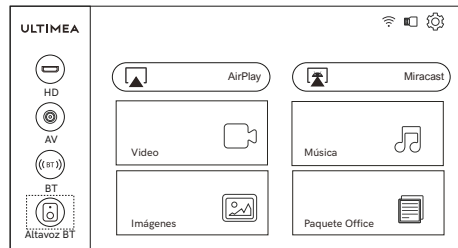



¡Disfrute su nuevo proyector!

**NOUS SOMMES
TOUJOURS PRÊTS
À VOUS AIDER.**



support@ultimea.com

**Vous préférez le
tutoriel vidéo ?**

Vidéo de conseils d'installation
et manuels d'utilisation sur le site
Web d'ULTIMEA.



support.ultimea.com



@Ultimea_Official  +1 888-598-8875 (US) Mon-Fri 9am-5pm (PST)
+49 89-628-25828 (EU) Mon-Fri 9am-5pm (CET)

IMPORTANT: Avant d'utiliser le projecteur, assurez-vous d'avoir lu ces instructions et les consignes de sécurité du manuel de l'utilisateur en ligne. Votre produit peut différer des illustrations de cette fiche, mais les instructions sont les mêmes.

Remarque:

En raison du protocole HDCP, Netflix, Amazon Prime et les services similaires ne peuvent pas être lus sans fil via le projecteur. Veuillez utiliser une Fire TV Stick, une Roku Stick ou Chromecast TM (non inclus) et la connecter au projecteur pour utiliser leurs services de diffusion en continu.

1 Liste des Accessoires



Apollo P40



Télécommande
(Piles non incluses)



Guide Rapide



Câble AV



Câble HD



Câble d'alimentation

2 Produit

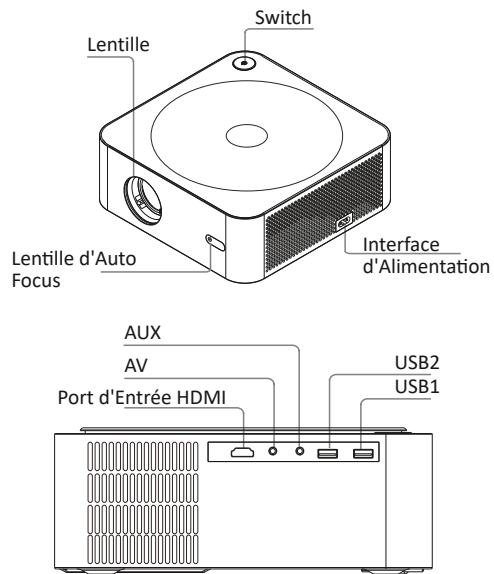

3 Télécommande

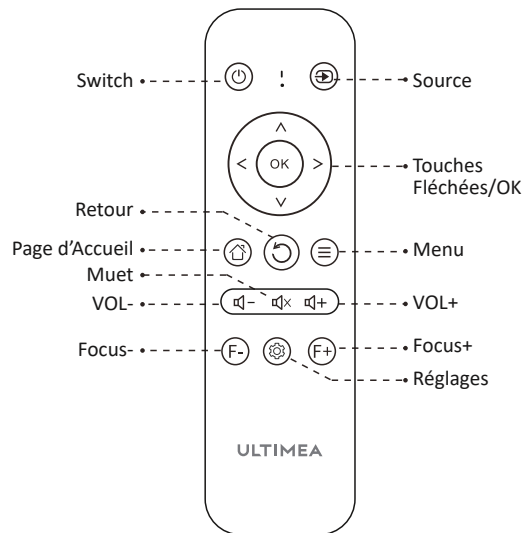

4 Réglages Rapides

4.1 Ouvrir / Fermer

Branchez le cordon d'alimentation secteur, cliquez sur le bouton d'alimentation sur le panneau de commande de la machine ou sur la télécommande, et le projecteur commencera à fonctionner.



4.2 Installation du Projecteur

Vous pouvez choisir un placement horizontal ou une installation suspendue.

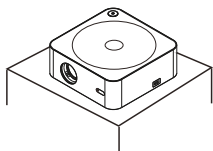

Placement Horizontal

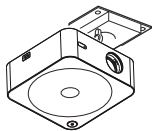

Installation Suspendue

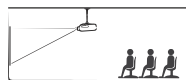

- ❶ Montage au plafond pour projection frontale.

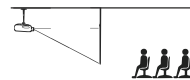

- ❸ Montage au plafond pour rétroprojection.

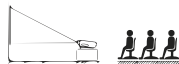

- ❷ Montage sur table pour projection avant.

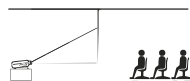

- ❹ Montage sur table pour rétroprojection.

L'écran de projection peut être joué de 35" à 150".
L'écran de projection recommandé est de 50" à 100".
L'obscurité ambiante améliore la clarté des images projetées.

4.3 Ajuster l'image projetée sur l'écran

Vérifiez les paramètres horizontaux et verticaux de l'écran.

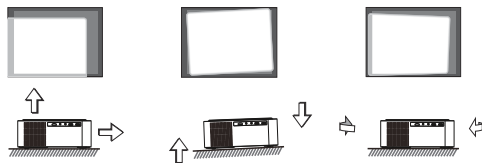

4.4 Paramètres Wi-Fi

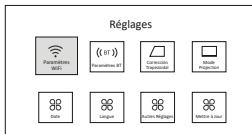

1. Cliquez sur l'icône des paramètres sur la page d'accueil pour accéder aux paramètres du projecteur.

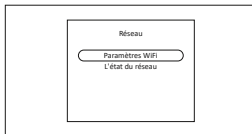

2. Sélectionnez "WiFi" et cliquez sur "OK" pour confirmer.

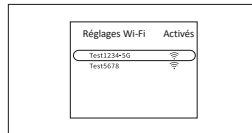

3. Après de la liste des réseaux apparaît, sélectionnez le réseau WiFi qui doit être connecté et appuyez sur le bouton "OK" pour confirmer.



4. Cliquez sur le bouton de connexion après avoir saisi le mot de passe.

4.5 Paramètres BT

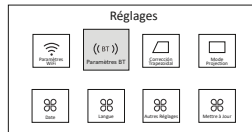

1. Cliquez sur l'icône des paramètres sur la page d'accueil, entrez les réglages du projecteur, sélectionnez le bouton "BT" cliquez sur "OK" pour confirmer.

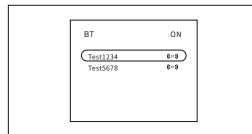

2. Activez BT et sélectionnez le signal BT qui doit être connecté.

5 Mise en Miroir d'Ecran

Pour Appareil iOS

1. Déplacez le curseur du projecteur sur AirPlay sur la page d'accueil, sélectionnez AirPlay et cliquez sur le bouton "OK".

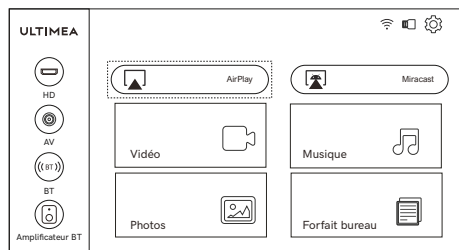

Remarque: Assurez-vous que le projecteur et le téléphone mobile sont connectés au même réseau.

2. Les étapes de fonctionnement du téléphone mobile sont les suivantes : Aucun réglage n'est requis sur le projecteur.

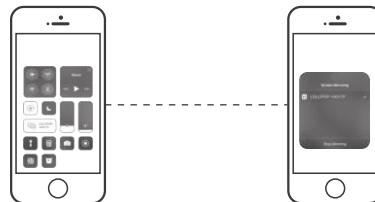

Étape 1:
Ouvrez le Centre de contrôle et appuyez sur Screen Mirroring sur votre appareil iOS.

Étape 2:
Sélectionnez l'appareil U0320 à diffuser parmi les appareils recherchés.

Pour Appareil Android

1. Déplacez le curseur du projecteur sur Miracast sur la page d'accueil, sélectionnez Miracast et cliquez sur le bouton "OK".

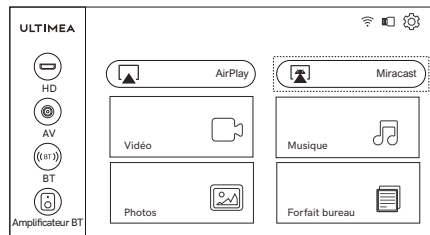

2. Allumez l'appareil Android, entrez les paramètres du téléphone pour trouver "Connectivité de l'appareil", cliquez sur "Affichage sans fil", recherchez U0320 du projecteur et sélectionnez U0320. Assurez-vous que le projecteur et l'appareil Android sont connectés au même réseau.

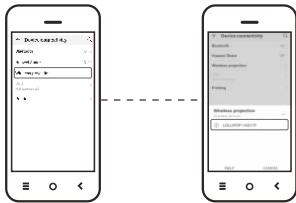

Remarque:

En raison du protocole HDCP, Netflix, Amazon Prime et les services similaires ne peuvent pas être lus sans fil via le projecteur. Veuillez utiliser une Fire TV Stick, une Roku Stick ou Chromecast TM (non inclus) et la connecter au projecteur pour utiliser leurs services de diffusion en continu.

6 Connexion Filaire aux Appareils

Fire TV Stick

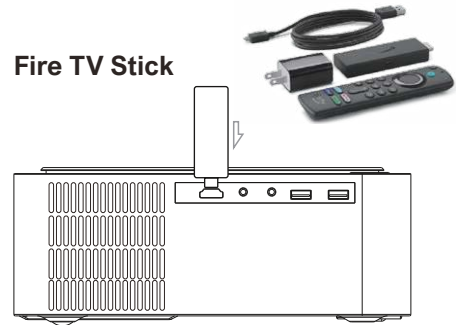

Comment connecter la clé Fire TV au projecteur ?

1. Connectez la clé TV à l'alimentation à l'aide du câble USB.
2. Branchez la clé TV sur le port HD du projecteur.
3. Sélectionnez l'option HD dans les paramètres du projecteur. Le contenu de la clé Fire TV s'affichera sur l'écran de projection. Utilisez la télécommande du Fire stick pour sélectionner et diffuser votre contenu.

6.1 Canal HD

Utilisez un câble HD pour connecter le projecteur à un ordinateur, une console de jeux, un décodeur et d'autres appareils prenant en charge la sortie HD et sélectionnez l'option HD dans les paramètres. Remarque : en raison des protocoles de type C, l'appareil Android ne peut pas être lu par une connexion par câble HD.

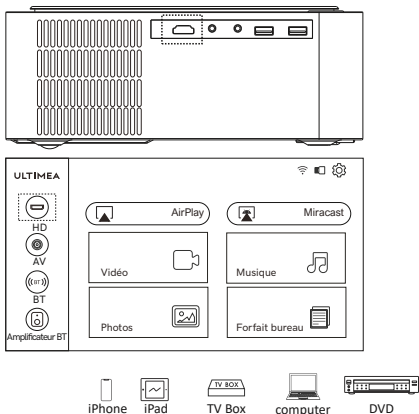

Remarque: En raison des protocoles de Type-C, les appareils Android ne peuvent pas être lus via une connexion par câble HD.

Utilisez un câble AV pour connecter le projecteur à un lecteur DVD, un décodeur et d'autres appareils prenant en charge la sortie AV .

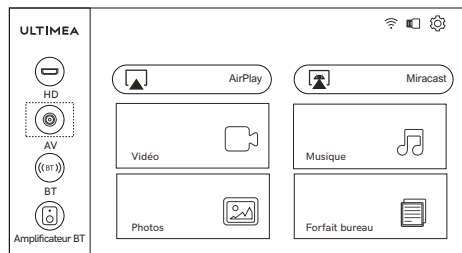
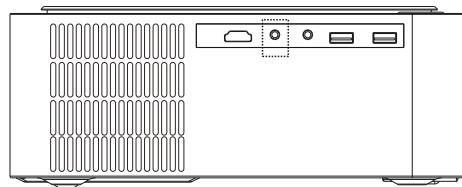

6.3 Canal Multimédia

Après avoir inséré la clé USB, sélectionnez le film, la musique, les images ou le fichier de bureau en fonction du type de fichier que vous devez lire et entrez dans le menu de lecture correspondant.

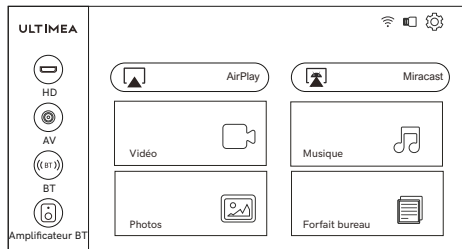
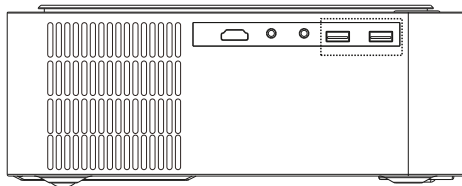

7 Mode de Haut-Parleur BT

Allumez le projecteur et accédez à la page d'accueil, utilisez la télécommande pour sélectionner le haut-parleur BT et appuyez sur le bouton "OK". L'écran affichera le mode haut-parleur BT et entrera en attente de jumelage. Vous pouvez vous connecter au projecteur (Nom: BT-U0320) via les paramètres BT de l'appareil mobile.

Pour utiliser la fonction projecteur, appuyez sur le bouton de retour pour quitter le mode haut-parleur BT. Maintenant, la machine s'allumera et entrera en mode projecteur.

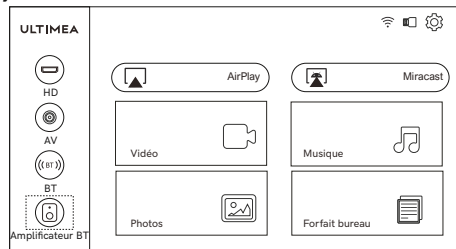

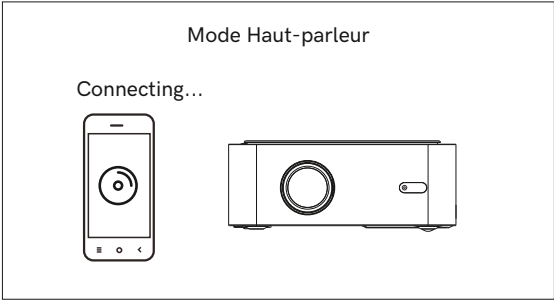

Profitez de votre nouveau projecteur !

SIAMO PRONTI PER AIUTARTI



support@ultimea.com

Preferisci i video tutorial?

Video sul setup e Manuali Utente sul sito ULTIMEA.



support.ultimea.com



@Ultimea_Official

+1 888-598-8875 (US) Mon-Fri 9am-5pm (PST)
+49 89-628-25828 (EU) Mon-Fri 9am-5pm (CET)

IMPORTANTE: Prima di usare il proiettore, assicurati di leggere queste istruzioni e le istruzioni di sicurezza presenti nel Manuale Utente online. Il tuo prodotto potrebbe essere diverso dalle illustrazioni in questa pagina, ma le istruzioni sono le stesse.

Nota: a causa del protocollo HDCP Netflix, Amazon Prime e servizi simili non possono essere riprodotti dal proiettore. Si prega di utilizzare una Fire TV, Roku o Chromecast TM (non inclusi) e connetterli al proiettore per utilizzare i loro servizi di streaming.

1 Lista degli Accessori



Apollo P40



Telecomando
(batterie non incluse)



Guida rapida



Cavo AV



Cavo HD



Cavo di Alimentazione

2 Prodotto

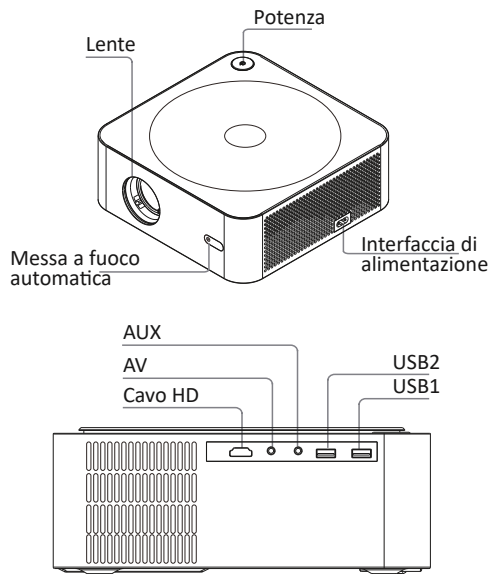

3 Telecomando

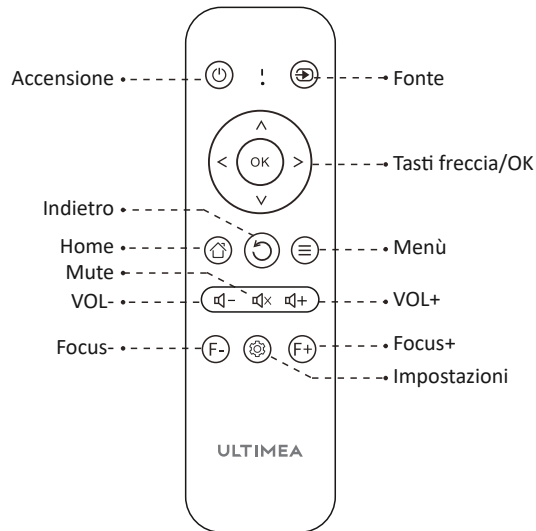

4 Impostazione rapida

4.1 Accensione / Spegnimento

Collegare il cavo di alimentazione AC, premere sul pulsante di accensione sul pannello operativo della macchina o sul telecomando e il proiettore inizierà a funzionare.



4.2 Installazione del proiettore

Puoi scegliere il posizionamento orizzontale o l'installazione su gancio.

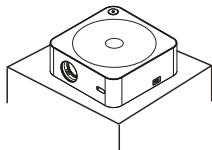

Posizionamento
orizzontale

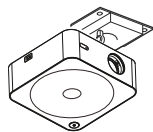

Installazione
su gancio

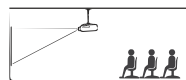

❶ Montaggio a soffitto
per proiezione
frontale

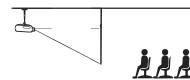

❸ Montaggio a soffitto
per retroproiezione



❷ Supporto per tavolo
per proiezione
frontale

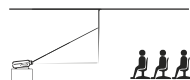

❹ Supporto da tavolo
per retroproiezione

Lo schermo della proiezione può essere da 35" a 150".
Lo schermo di proiezione consigliato è da 50" a 100".
L'assenza di luce nell'ambiente migliorerà la nitidezza
delle immagini proiettate.

4.3 Regolare l'immagine proiettata sullo schermo

Controlla le impostazioni orizzontali e verticali dello schermo.

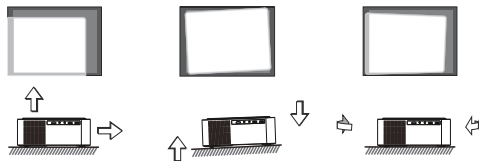

4.4 Impostazioni Wi-Fi



1. Premi sull'icona delle impostazioni nella home page per accedere alle impostazioni del proiettore.



2. Seleziona "WiFi" e premere su "OK" per confermare.

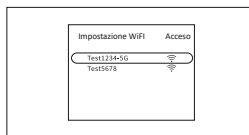

3. Dopo aver cercato la rete verrà visualizzato l'elenco delle reti. Seleziona la rete wireless che deve essere collegata e premi il pulsante "OK" per confermare.



4. Premi su connetti dopo aver inserito la password.

4.5 Impostazioni del BT

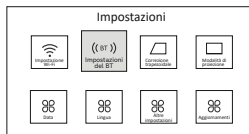

1. Premi sull'icona delle impostazioni nella home page per accedere alle impostazioni del proiettore, seleziona il pulsante "BT" e premi su "OK" per confermare.

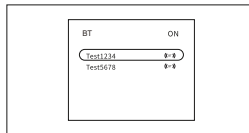

2. Attiva il BT e seleziona il segnale BT da collegare.

5 Mirroring dello Schermo

Per dispositivi iOS

1. Sposta il cursore del proiettore su AirPlay nella home page, seleziona AirPlay e premi sul pulsante "OK".

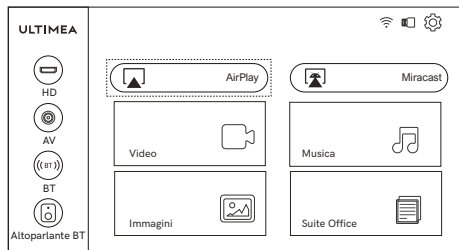

Nota: assicurati che il proiettore e il telefono cellulare siano collegati alla stessa rete.

2. Per utilizzare il telefono mobile, seguire i seguenti step:
Non è necessario modificare alcuna impostazione sul proiettore.

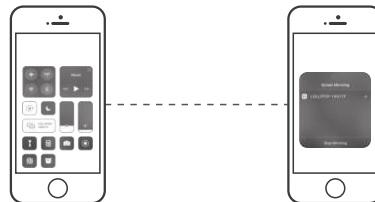

Passaggio 1 :
apri il Centro di controllo e premi Screen Mirroring sul tuo dispositivo iOS.

Passaggio 2 :
seleziona tra i dispositivi trovati da trasmettere il dispositivo U0320.

Per dispositivi Android

1. Sposta il cursore del proiettore su Miracast nella home page, seleziona Miracast e premere sul pulsante "OK".

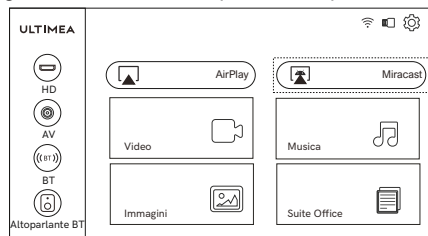

2. Accendi il dispositivo Android, nelle impostazioni del telefono, cerca "Connettività dispositivo", premi su "Wireless Display", cerca la sigla U0320 del proiettore e seleziona U0320. Assicurati che il proiettore e i dispositivi Android sono connessi alla stessa rete.

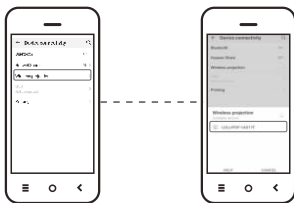

Nota:

a causa del protocollo HDCP Netflix, Amazon Prime e servizi simili non possono essere riprodotti dal proiettore. Si prega di utilizzare una Fire TV, Roku o Chromecast TM (non inclusi) e connetterli al proiettore per utilizzare i loro servizi di streaming.

6 Connessione Cablata ai Dispositivi

Fire TV Stick

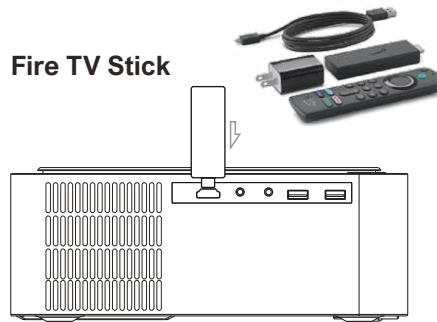

Come collegare la Fire TV Stick al proiettore:

1. Collegare la stick TV all'alimentazione utilizzando il cavo USB.
2. Collegare la stick alla porta HD del proiettore.
3. Selezionare l'opzione HD nelle impostazioni del proiettore. Il contenuto della chiavetta Fire TV verrà visualizzato sullo schermo di proiezione. Usa il telecomando della Fire Stick per selezionare e riprodurre in streaming i tuoi contenuti.

6.1 Canale HD

Utilizza un cavo HD per collegare il proiettore a un computer, una console, un decoder e altri dispositivi che supportano l'uscita HD, e seleziona l'opzione HD nelle impostazioni.

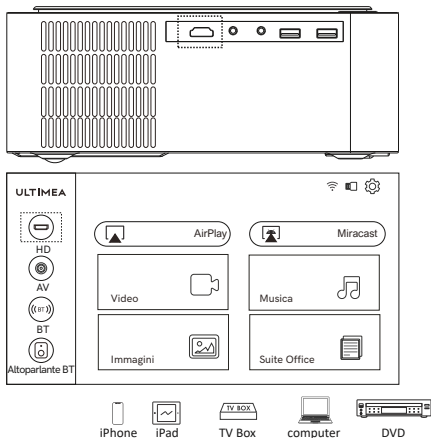

Note: a causa dei protocolli di tipo C, i dispositivi android non possono essere riprodotti dalla connessione cablata HD.

6.2 Canali AV

Utilizza un cavo AV per collegare il proiettore a un lettore DVD, set-top box e altri dispositivi che supportano l'uscita AV.

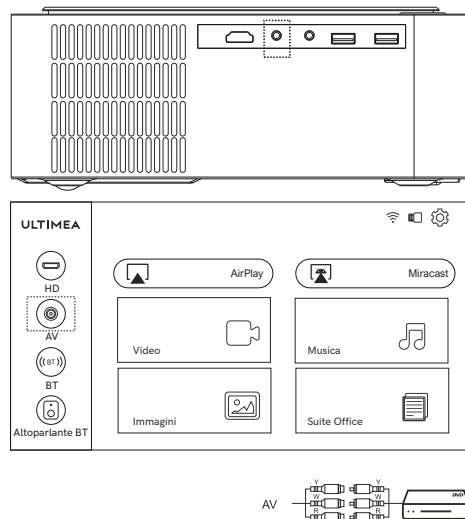

6.3 Canale multimediale

Dopo aver inserito l'USB, seleziona il film, la musica, le immagini o il file Office in base al tipo di file che devi riprodurre e accedi al menu di riproduzione corrispondente.

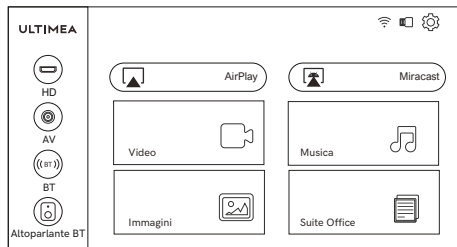
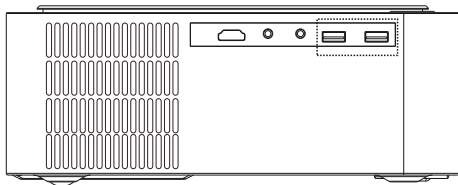

7 Modalità altoparlante BT

Accendi il proiettore e accedi alla home page, utilizza il telecomando per selezionare l'altoparlante BT e premi il pulsante "OK". Il display mostrerà la modalità altoparlante BT e apparirà la scritta "in attesa di associazione". Puoi connetterti al proiettore (Nome: U0320) tramite le impostazioni BT del dispositivo mobile.

Per utilizzare la funzione proiettore, premere il pulsante indietro per uscire dalla modalità altoparlante BT. Il dispositivo si accenderà ed entrerà in modalità proiettore.

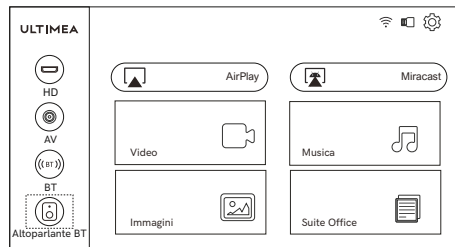

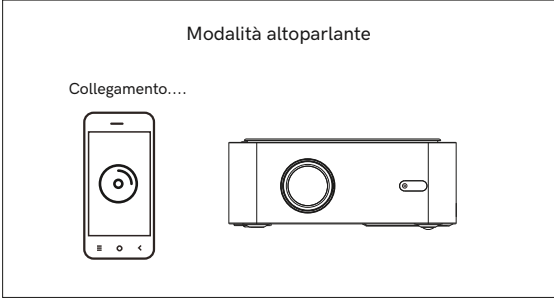

Goditi il tuo nuovo proiettore!

FCC STATEMENT:

This device complies with Part 15 of the FCC Rules. Operation is subject to the following two conditions:

- (1) This device may not cause harmful interference.
- (2) This device must accept any interference received, including interference that may cause undesired operation.

ISED WARNINGS

This device contains licence-exempt transmitter(s)/receiver(s) that comply with Innovation, Science and Economic Development Canada's licence-exempt RSS(s).

Operation is subject to the following two conditions:

- (1) This device may not cause interference.
- (2) This device must accept any interference, including interference that may cause undesired operation of the device.

L'émetteur/récepteur exempt de licence contenu dans le présent appareil est conforme aux CNR d'Innovation, Sciences et Développement économique Canada applicables aux appareils radio exempts de licence. L'exploitation est autorisée aux deux conditions suivantes :

- (1) L'appareil ne doit pas produire de brouillage;
- (2) L'appareil doit accepter tout brouillage radioélectrique subi, même si le brouillage est susceptible d'en compromettre le fonctionnement.

Le présent appareil est conforme. Après examen de ce matériel aux limites d'intensité de champ RF, les utilisateurs peuvent sur l'exposition aux radiofréquences et compliance d'acquérir les informations correspondantes. La distance minimale du corps à utiliser le dispositif est de 20cm.

FCC Radiation Exposure Statement:

This equipment complies with FCC radiation exposure limits set forth for an uncontrolled environment. This equipment should be installed and operated with minimum distance 20cm between the radiator&your body.

WARNING

Changes or modifications not expressly approved by the party responsible for compliance could void the user's authority to operate the equipment.

NOTE: This equipment has been tested and found to comply with the limits for a Class B digital device, pursuant to Part 15 of the FCC Rules. These limits are designed to provide reasonable protection against harmful interference in a residential installation. This equipment generates uses and can radiate radio frequency energy and, if not installed and use in accordance with the instructions, may cause harmful interference to radio communications. However there is no guarantee that interference will not occur in a particular installation. If this equipment does cause harmful interference to radio or television reception, which can be determined by turning the equipment off and on, the user is encouraged to try to correct the interference by one or more of the following measures:

Reorient or relocate the receiving antenna.

Increase the separation between the equipment and receiver.

Connect the equipment into an outlet on a circuit different from that to which the receiver is connected.

Consult the dealer or an experienced radio/TV technician for help.

Declaration of Conformity

We(Manufacturer is responsible for this declaration) Dynanic (Shenzhen) Technology Limited

20th Floor, Building 4, Tianan Cloud Park, Bantian St., Longgang District, Shenzhen,China

Declare under our sole responsibility that the product

Trade name: ULTIMEA

Equipment: Projector

Model No.: U0320

To which this declaration relates is in conformity with the essential requirement set out in the Council Directive on the Approximation of the laws of the Member

States relating to LVD Directive(2014/53/EU)&Rohs (2011/65/EU) product is responsible to affix CE marking,the following standards were applied:

EN 62368-1:2014+A11:2017
EN IEC 62311:2020
ETSI EN 301 489-1 V2.2.3(2019-11)
ETSI EN 301 489-17 V3.2.4(2020-09)
EN 55032:2015
EN 55035:2017
EN 61000-3-2:2019
EN 61000-3-3:2013+A1:2019
ETSI EN 300 328 V2.2.2(2019-7)
IEC 62321-3-1:2013
IEC 62321-5:2013
IEC 62321-4:2013+AMD1:2017
IEC 62321-6:2015
IEC 62321-7-2:2017
IEC 62321-6:2015
IEC 62321-8:2017

Signature:  Date: 2023.1.6

@Dyanic Inc. All rights reserved, registered in the United States and other countries.
16192 Coastal Hwy Lewes DE 19958, United States

EC	REP	SHUNSHUN GmbH Römeräcker 9 Z2021, 76351 Linkenheim-Hochstetten, Germany
UK	REP	UK Crossborder limited 7 Bell Yard London WC2A 2JR, UK United Kingdom

Made in China
Manufacturer: Dyanic (Shenzhen) Technology Limited
Address: 20th Floor, Building 4, Tianan Cloud Park, Bantian St.,
Longgang District, Shenzhen, China 518000
FCC ID: 2A9OO-U0320P
IC: 29805-U0320P



ULTIMEA

If we can be of assistance, please do not hesitate to contact us.

 +1 888-598-8875 (US) +49 89-628-25828 (EU)
Mon-Fri 9am-5pm (PST) Mon-Fri 9am-5pm (CET)

 support@ultimea.com

 support.ultimea.com



[@ultimea_official](#)

