

CDK - 0383

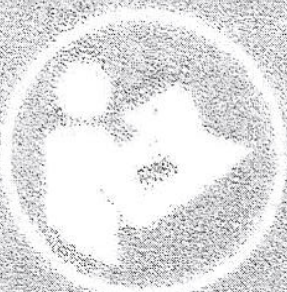

- |   |                                     |
|---|-------------------------------------|
| <b>(D)</b> Montageanleitung             | <b>(GB)</b> Assembly instructions   |
| <b>(FR)</b> Notice de montage           | <b>(IT)</b> Istruzioni di montaggio |
| <b>(NL)</b> Handleiding voor de montage | <b>(PL)</b> Instrukcja montażu      |
| <b>(CZ)</b> Montážní návod              | <b>(SK)</b> Návod na montáž         |
| <b>(HU)</b> Szerelési útmutató          | <b>(RO)</b> Instrucțiuni de montaj  |
| <b>(TR)</b> Montaj talimatı             | <b>(RU)</b> инструкция по монтажу   |

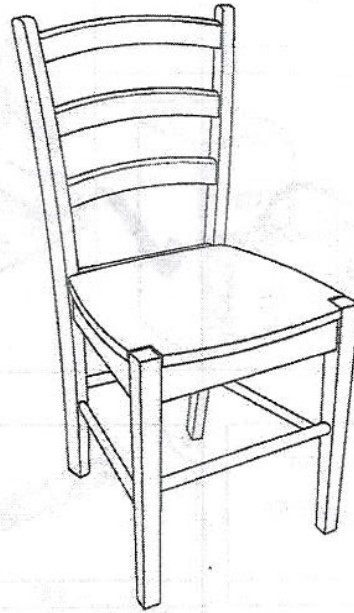
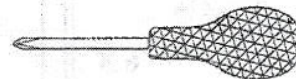

**Service • Assistenza • Dienstverlening • Serwis  
Servis • Szerviz • Сервисная служба**

Name • Nom • Nomo • Naam •  
Nazwa • Jméno • Názov • Név •  
Denumire • İsim • Hoznév

Nr. • No. • N° • Номер • Č. • Sz.

Typ • Type • Tip • Típus • Tipo •  
Typ

8

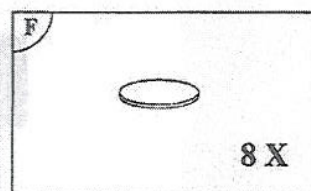
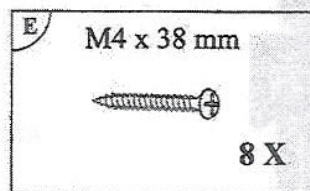
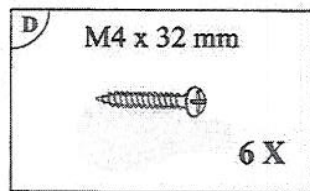
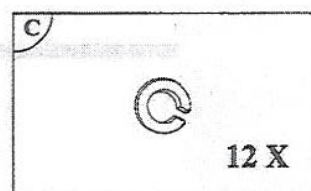
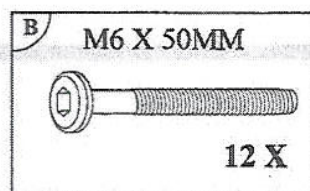
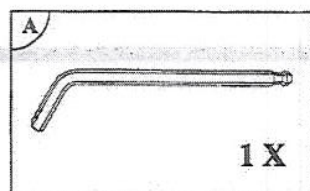
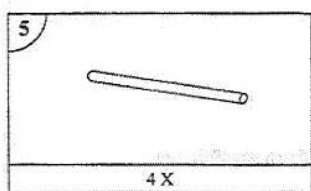
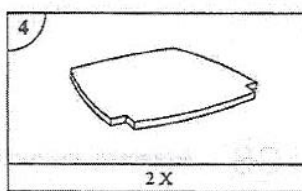
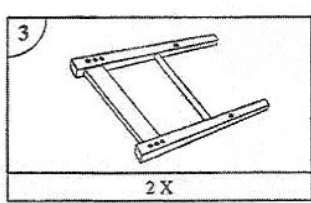
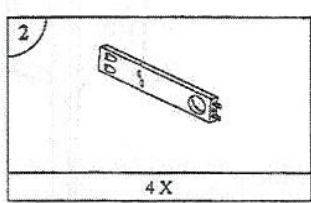
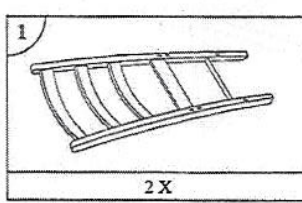
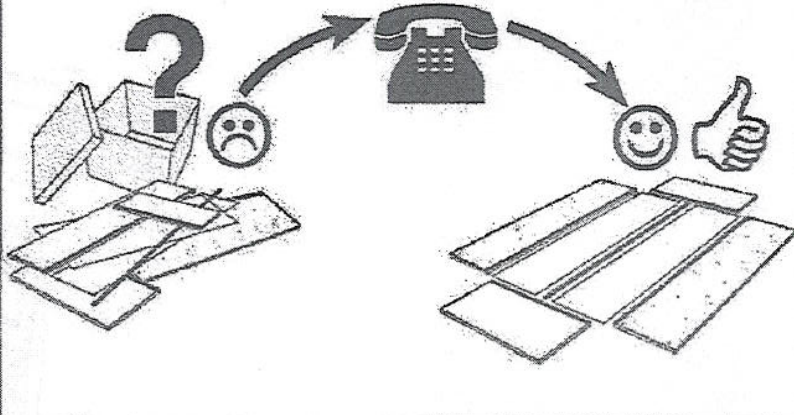
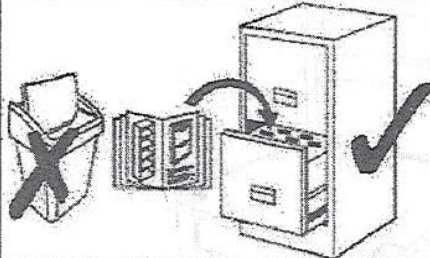

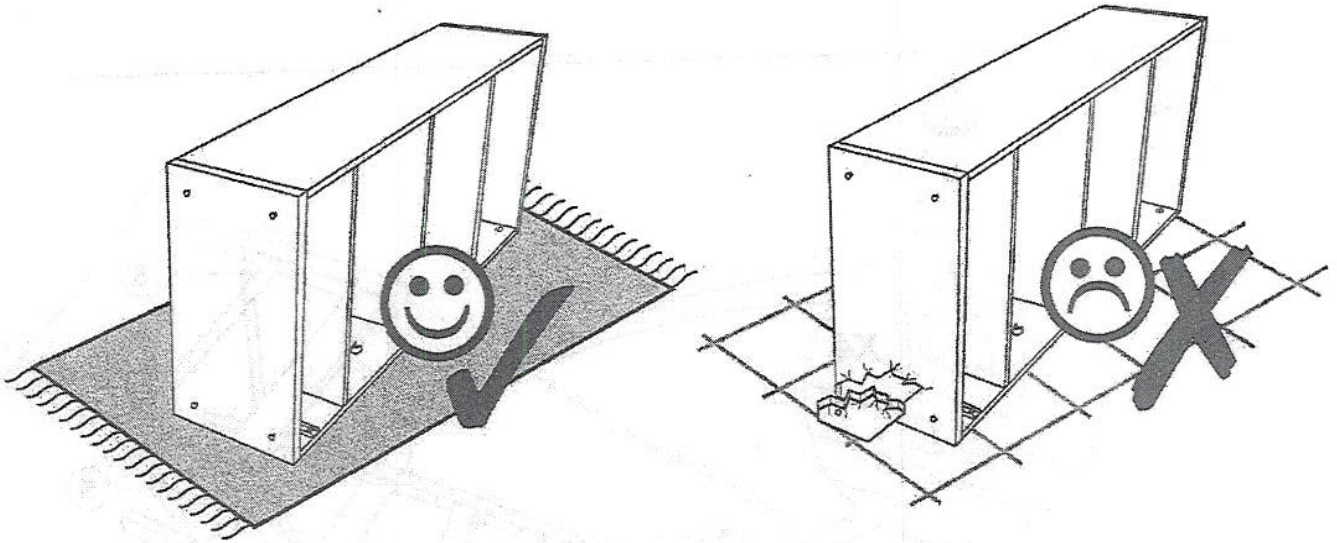

**1**

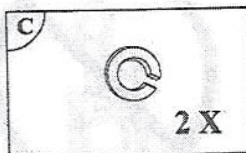
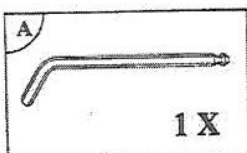
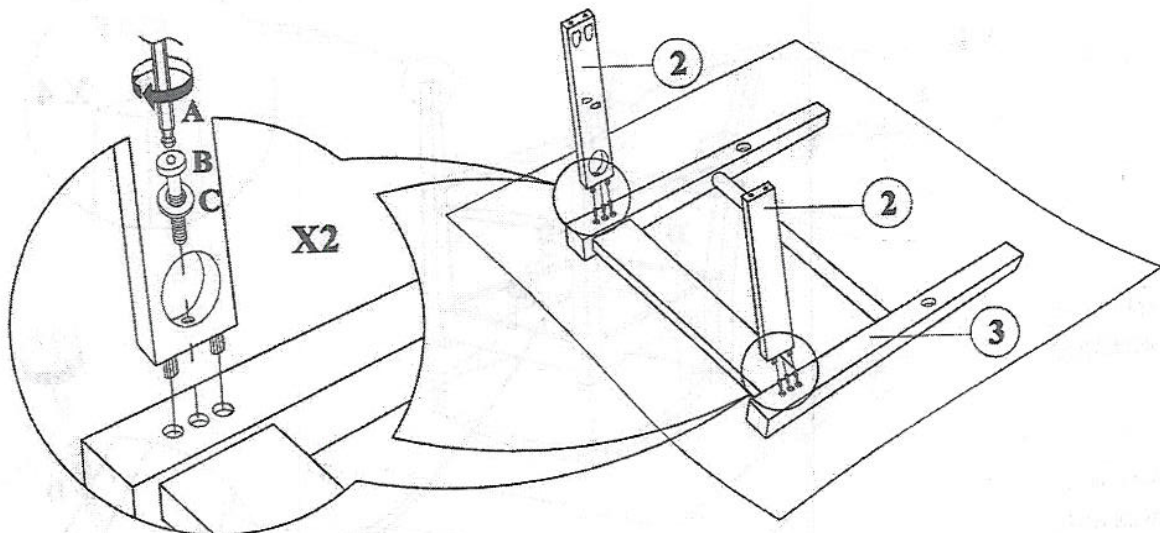

2

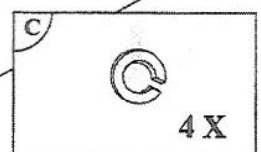
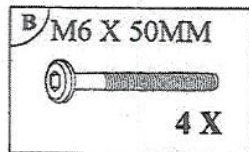
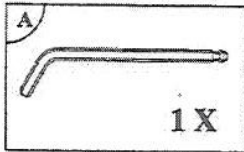
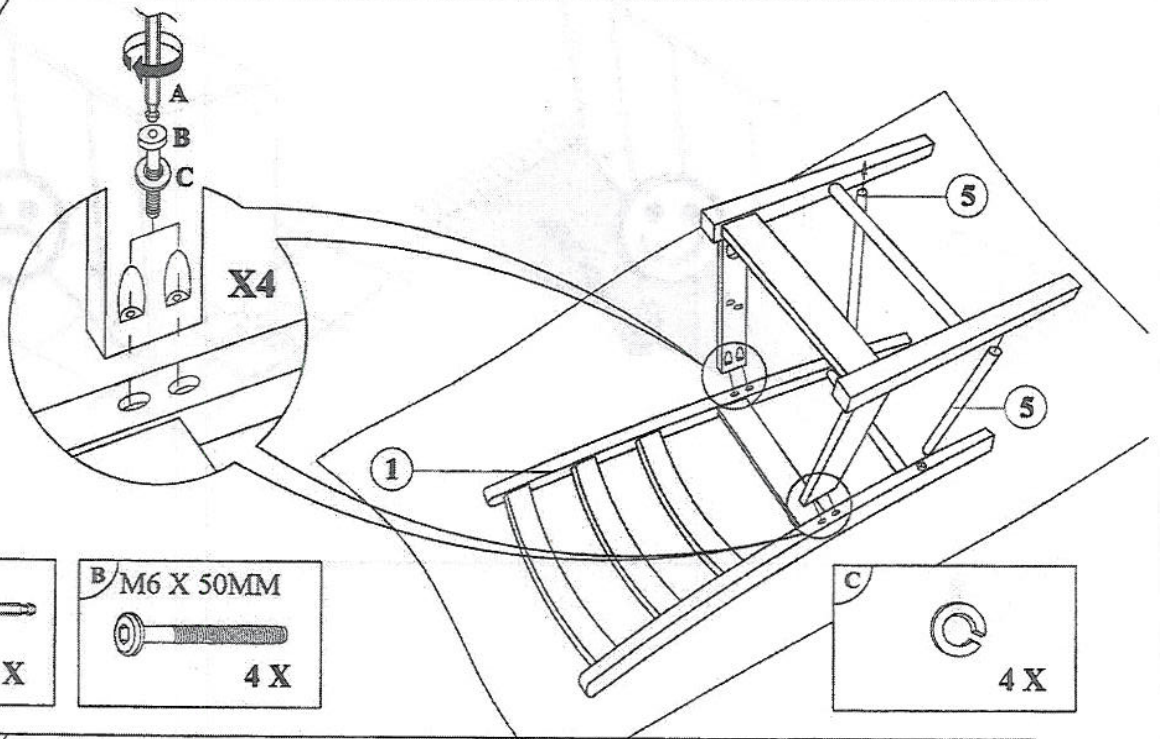

3

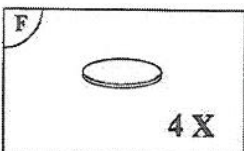
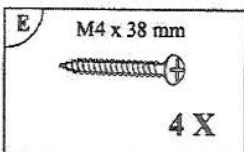
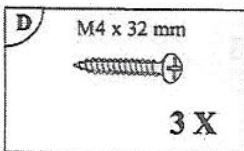
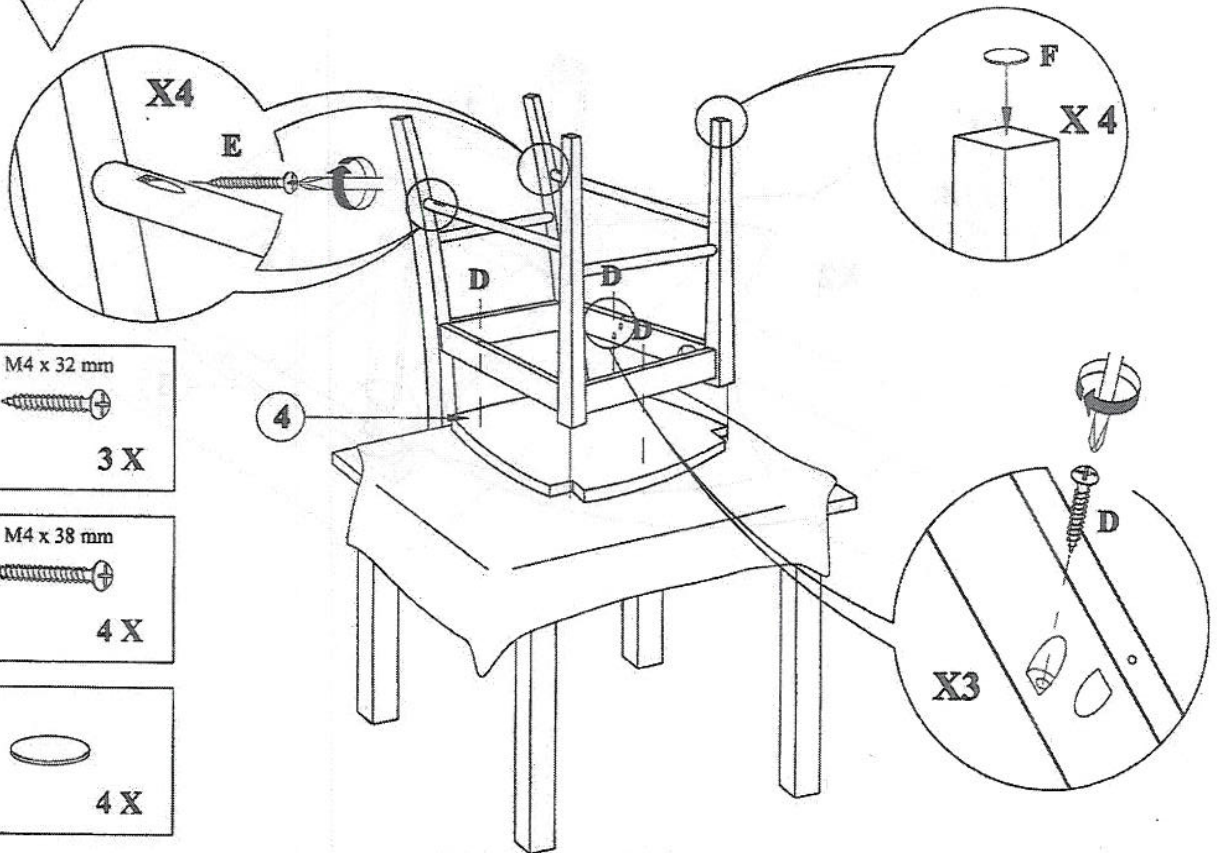

<b>2</b>	<b>D</b>	Ziehen Sie alle Schrauben sowie tragende Verbindungsteile nach ca. 5 Wochen nach, um eine dauerhafte Standsicherheit zu gewährleisten.
	<b>GB</b>	After approx. 5 weeks, tighten all screws and load-bearing connecting parts to ensure permanent stability.
	<b>FR</b>	Resserrez toutes les vis ainsi que les pièces de fixation au bout d'environ 5 semaines pour garantir une sécurité de fixation durable.
	<b>IT</b>	Ristringere tutte le viti e giunture dopo ca. 5 settimane, al fine di garantire una durevole solidità.
	<b>NL</b>	Draai alle schroeven en ook dragende verbindingstukken na ca. 5 weken nog eens vast, zodat een continue stabiliteit wordt gegarandeerd.
	<b>PL</b>	Prosimy po ok. 5 tygodniach dokręcić wszystkie śruby w elementach łączących. Zagwarantuje to Państwu trwałość i stabilność połączeń.
	<b>CZ</b>	Dotáhněte všechny šrouby a nosné spojovací díly přibližně po 5 týdnech, aby se zaručila trvalá stabilita.
	<b>SK</b>	Po cca 4 týždňoch dotiahnite skrutky, aby bola zaručená ich trvalá stabilita.
	<b>HU</b>	Húzza utána - kb. 5 hét múlva - az összes csavart és a teherhordó összekötő -alkatrészeket a biztonság érdekében.
	<b>RO</b>	Pentru a asigura o stabilitate de durată, strângeți după cca. 5 săptămâni toate șuruburile, precum și toate elementele portante de legătură.
	<b>TR</b>	Tüm vida ve taşıyıcı bağlantı parçalarını kalıcı bir duruş güvenliğini sağlamak için yaklaşık 5 hafta sonra tekrar sıkınız.
<b>RU</b>	Подкрутите все болты, а также несущие соединительные детали прибл. через 5 недель для обеспечения устойчивости в течение длительного времени.	
<b>3</b>	<b>D</b>	Bitte nur mit einem Staubtuch oder leicht feuchtem Lappen reinigen. Keine scheuernden Putzmittel verwenden.
	<b>GB</b>	Please only clean with a duster or a damp cloth. Do not use any abrasive cleaners.
	<b>FR</b>	Veuillez nettoyer uniquement avec un chiffon à poussière ou un chiffon légèrement humide. Ne pas utiliser de détergent abrasif.
	<b>IT</b>	Si raccomanda di pulire solo con un panno per la polvere o uno strofinaccio umido. Non utilizzare detersivi abrasivi.
	<b>NL</b>	Reinig alleen met een stofdoek of een lichtjes vochtige doek. Gebruik geen schurende poetsmiddelen.
	<b>PL</b>	Czyszczenie należy wykonać wyłącznie za pomocą ściereczki lub lekko nawilżonego ręcznika. Nie stosować środków czyszczących do szorowania.
	<b>CZ</b>	Čistěte prosím jen prachovkou nebo lehce navlhčeným hadrem. Nepoužívejte drhnuocí čisticí prostředky.
	<b>SK</b>	Na čistenie používajte len prachovku alebo zľahka navlhčenú utierku. Nepoužívajte žiadne drhnúce čistiace prostriedky.
	<b>HU</b>	Kérjük, csak portörő kendővel vagy enyhén nedves ronggyal tisztítsa. Ne használjon dörzsztátású tisztítószeret.
	<b>RO</b>	V? rug? m s? utiliza? i la cur? ? are exclusiv o cârp? de ? ters praful sau o cârp? u? or umezit? . Nu utiliza? i substan? e de cur? ? at abrazive.
	<b>TR</b>	Lütfen sadece bir toz beziyle veya hafif nemli yumuşak bir bezle siliniz. Aşındırıcı temizlik malzemeleri kullanmayınız.
	<b>RU</b>	Очищайте от пыли тряпкой или слегка влажной ветошью. Не допускается применение чистящих средств, не предназначенных для ухода за мебелью.