

# Elsa

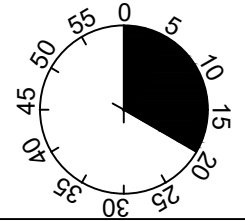
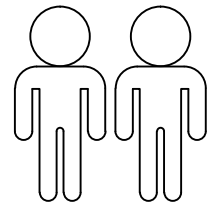
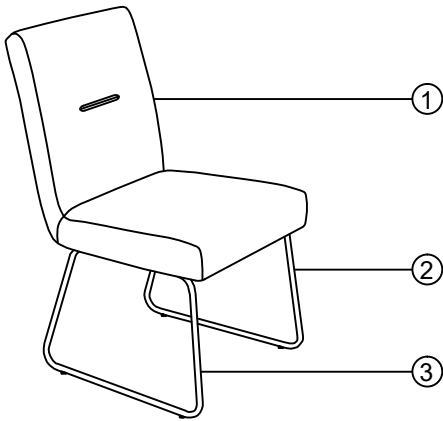

1

2

3

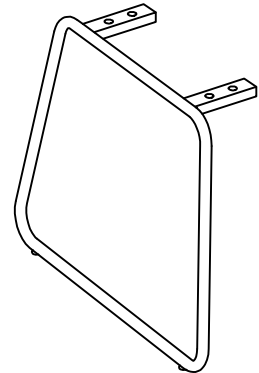
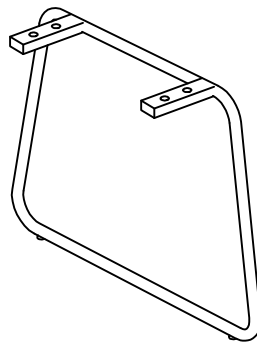
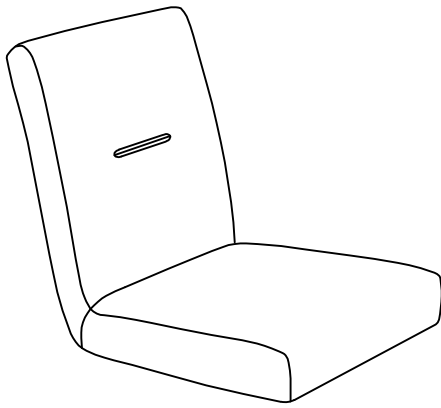

1	1X
2	1X
3	1X

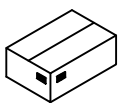

1/1

A

M8x35

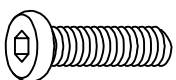

8x

B

Ø18xØ8x1.5



8x

C

5MM

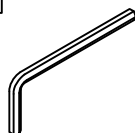

1x

I.

1

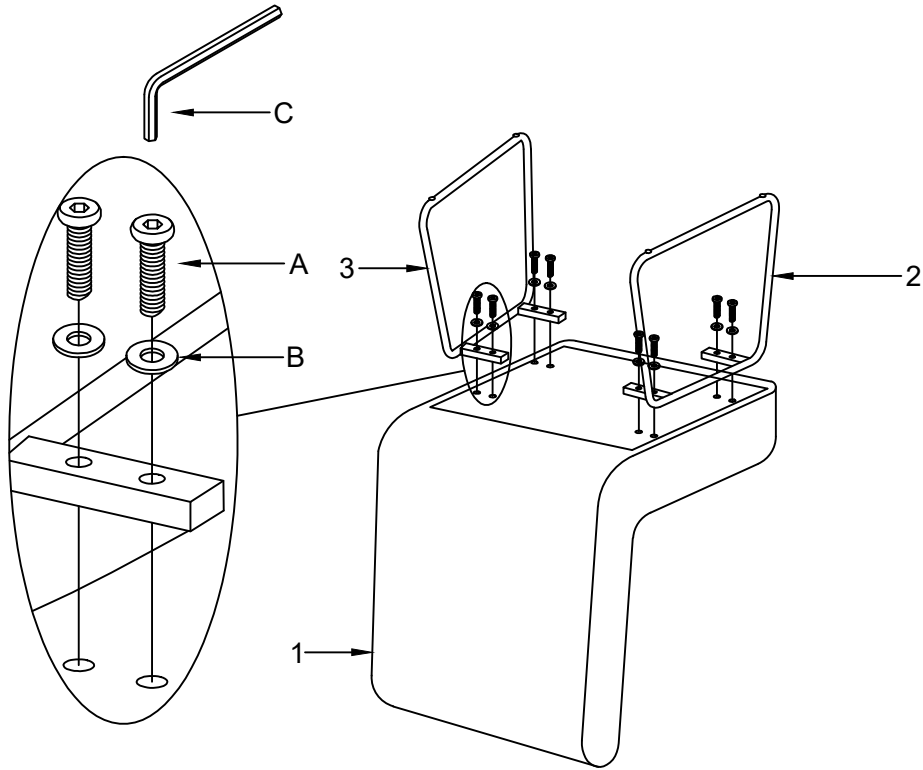

- A M8x35  
8x
  - B Ø18xØ8x1.5  
8x
  - C 5MM  
1x
- 

2

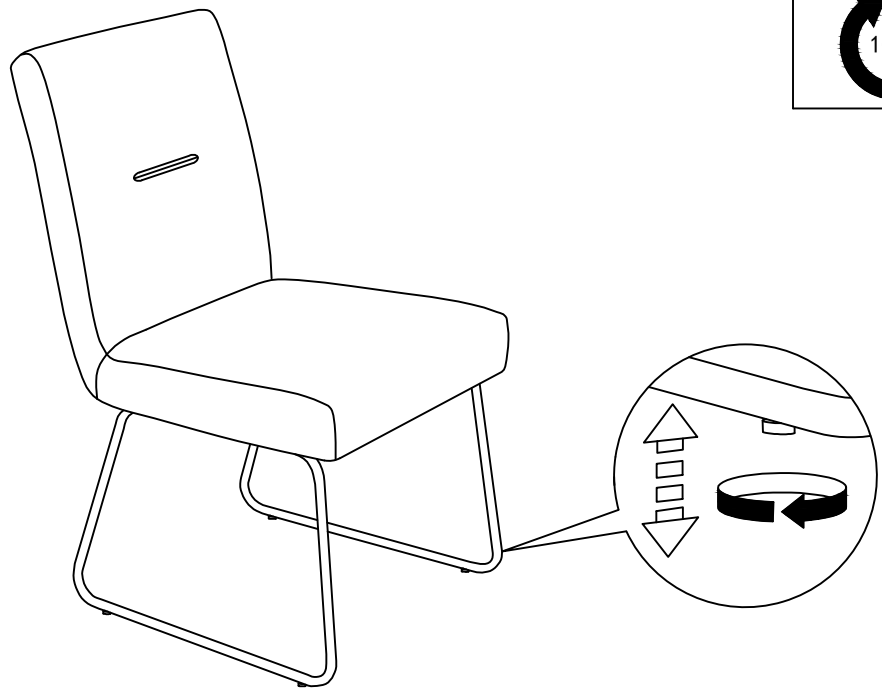

- C 5MM  
1x
- 



LE TRI  
+ FACILE



Séparez les éléments avant de trier