

INSTALLATIONSANLEITUNG INSTALLATION INSTRUCTION INSTRUCTION D'INSTALLATION

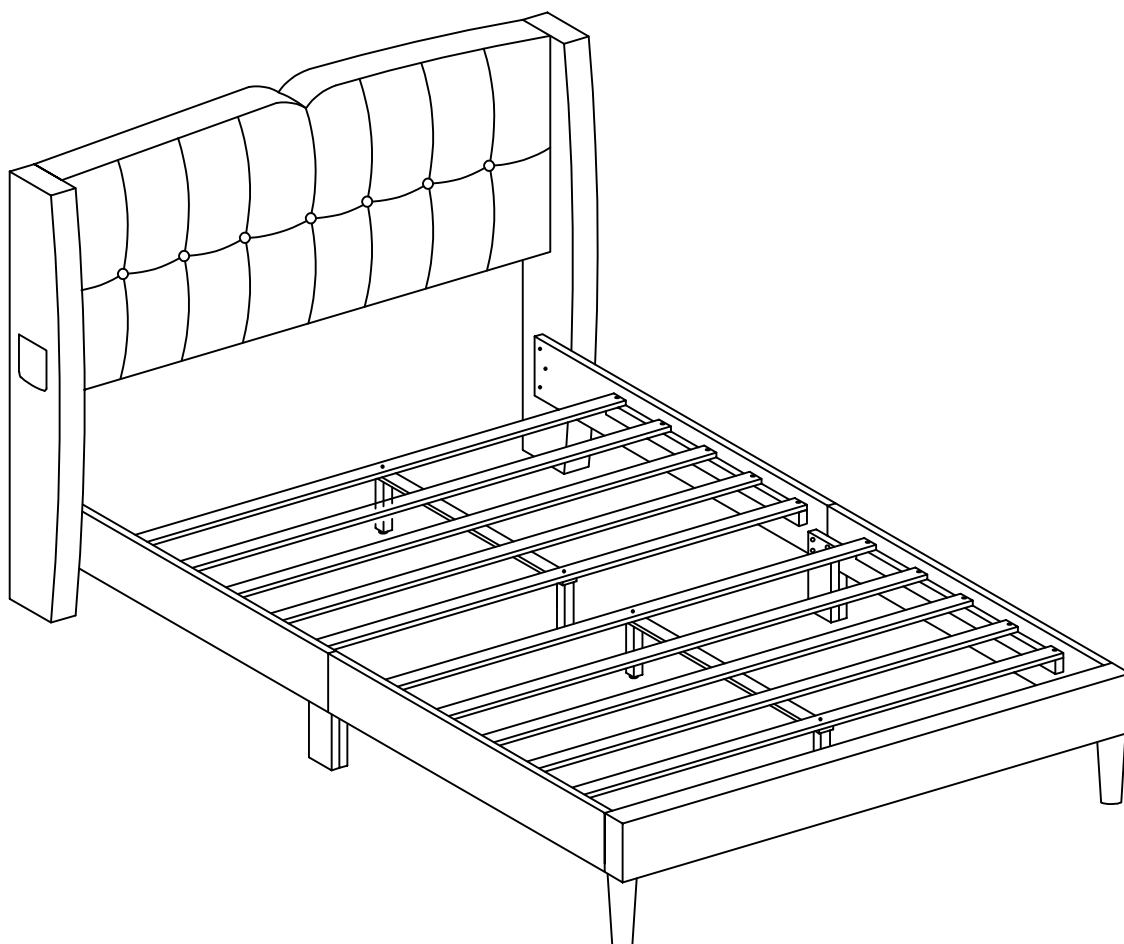

DE: Unser Produkt wird Ihnen in (2) Paketen geliefert. Die Lieferzeiten dieser (2) Pakete können abweichen, bitte haben Sie etwas Geduld und vielen Dank für Ihr Verständnis.

UK: Our product will be delivered to you in (2) packages. The delivery times of these (2) packages may differ, please be patient and thank you for your understanding.

FR: Notre produit vous sera livré en (2) colis. Les délais de livraison de ces (2) colis peuvent différer, soyez patient et merci pour votre compréhension.

N636P196779

N636P196782

English

IMPORTANT ! KEEP FOR FUTURE REFERENCE : READ CAREFULLY

- To be assembled by an adult. Assembly must be checked by an adult before use
- WARNING ! Keep all screws, small parts and plastic bags out of the reach of children
- Properly identify all parts before assembling
- Never use your item if any of its parts are broken or missing
- Should any problems arise, please contact our After Sales Service
- Manufacturer's instructions shall be followed at all times
- Care: Clean with a soft, dry cloth. In case of larger stains, carefully rub with a slightly damp, non-abrasive sponge
- Avoid the risk of fire by not placing furniture near sources of ignition or hot items
- Do not jump on the bed

Deutsch

WICHTIG ! ZUM SPÄTEREN NACHSCHLAGEN AUFBEWAHREN: SORGFÄLTIG LESEN

- Muss von einem Erwachsenen zusammengebaut werden. Der Zusammenbau muss vor dem Gebrauch von einem Erwachsenen überprüft werden
- WARNUNG! Bewahren Sie alle Schrauben, Kleinteile und Plastikbeutel außerhalb der Reichweite von Kindern auf
- Kennzeichnen Sie vor dem Zusammenbau alle Teile richtig
- Benutzen Sie Ihren Artikel niemals, wenn Teile gebrochen sind oder fehlen
- Sollten Probleme auftreten, wenden Sie sich bitte an unseren Kundendienst
- Die Anweisungen des Herstellers sind stets zu befolgen
- Pflege: Mit einem weichen, trockenen Tuch reinigen. Bei größeren Flecken vorsichtig mit einem leicht feuchten, nicht scheuernden Schwamm abreiben. nicht scheuernden Schwamm
- Vermeiden Sie die Gefahr eines Brandes, indem Sie die Möbel nicht in der Nähe von Zündquellen oder heißen Gegenständen aufstellen
- Nicht auf das Bett springen

Français

IMPORTANT ! CONSERVER POUR RÉFÉRENCE ULTÉRIEURE : LIRE ATTENTIVEMENT

- Le montage doit être effectué par un adulte. Le montage doit être vérifié par un adulte avant Utilisation
- ATTENTION ! Tenir les vis, les petites pièces et les sachets en plastique hors de portée des enfants
- Identifiez correctement toutes les pièces avant de les assembler
- N'utilisez jamais votre article si l'une de ses pièces est cassée ou manquante
- En cas de problème, veuillez contacter notre service après-vente
- Les instructions du fabricant doivent être respectées à tout moment
- Entretien : nettoyer avec un chiffon doux et sec. En cas de taches plus importantes, frotter soigneusement avec une éponge non abrasive légèrement humide. légèrement humide et non Abrasive
- Évitez les risques d'incendie en ne plaçant pas les meubles à proximité de sources d'inflammation ou d'objets chauds
- Ne pas sauter sur le lit

Italiano

IMPORTANTE! CONSERVARE PER RIFERIMENTO FUTURO: LEGGERE ATTENTAMENTE

- Deve essere assemblato da un adulto. L'assemblaggio deve essere controllato da un adulto prima dell'uso
- **ATTENZIONE!** Tenere tutte le viti, le piccole parti e i sacchetti di plastica fuori dalla portata dei bambini
- Identificare correttamente tutte le parti prima dell'assemblaggio
- Non utilizzare mai l'articolo se alcune parti sono rotte o mancanti
- In caso di problemi, si prega di contattare il nostro Servizio Post Vendita
- Le istruzioni del produttore devono essere sempre seguite
- Cura: Pulire con un panno morbido e asciutto. In caso di macchie più estese, strofinare accuratamente con una spugna leggermente umida e nonspugna leggermente umida e non abrasiva
- Evitare il rischio di incendio, non collocando i mobili vicino a fonti di accensione o a oggetti caldi
- Non saltare sul letto

Español

¡ IMPORTANTE ! CONSERVELO PARA FUTURAS CONSULTAS: LEA ATENTAMENTE



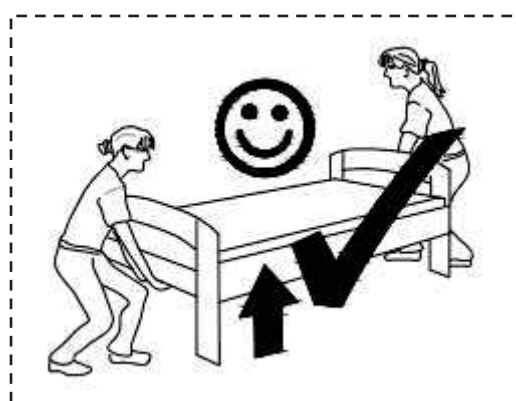
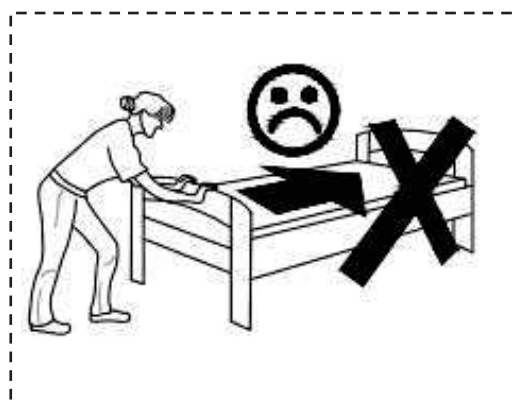

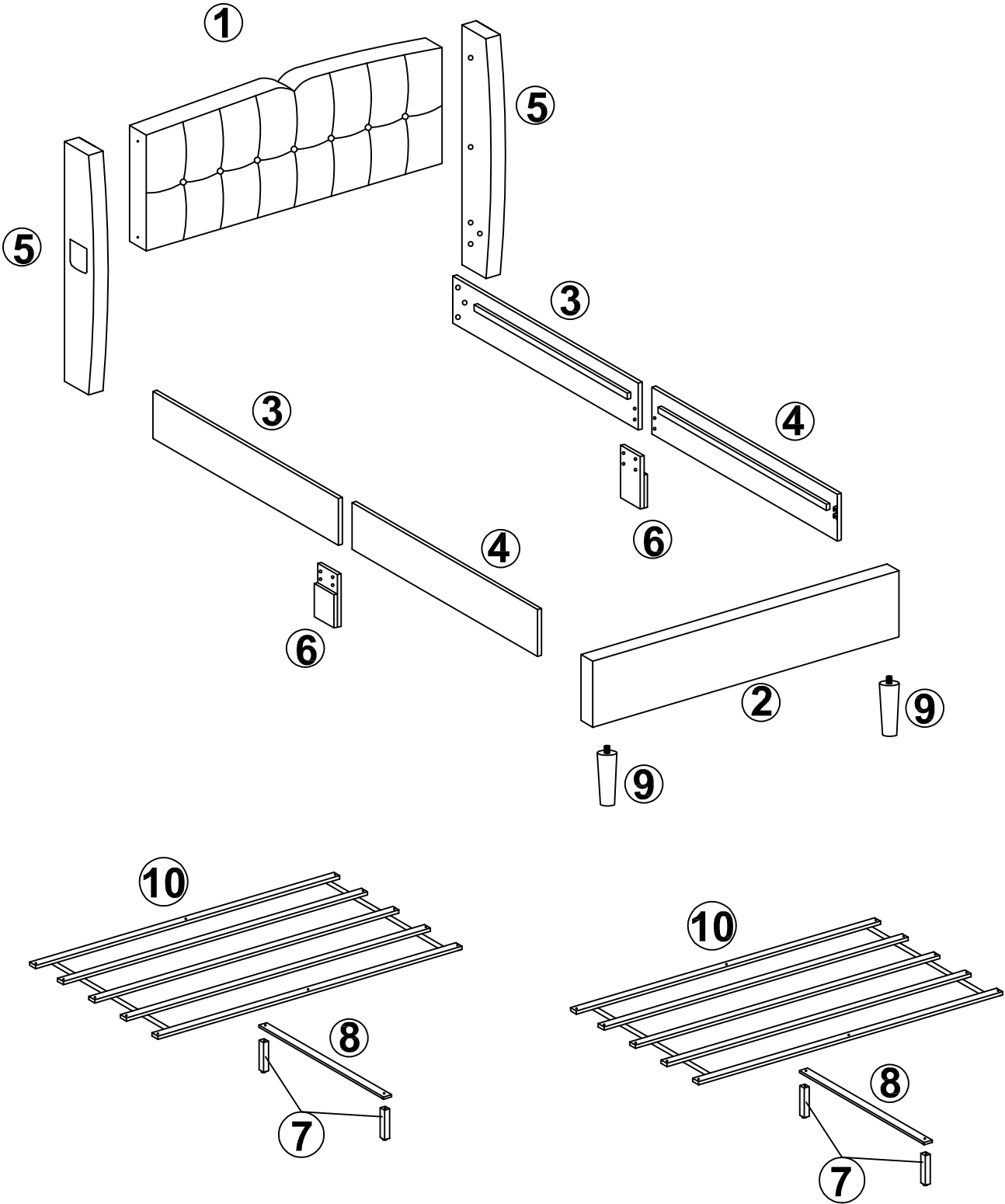

- Debe ser montado por un adulto. El montaje debe ser comprobado por un adulto antes del uso
- ADVERTENCIA Mantenga todos los tornillos, piezas pequeñas y bolsas de plástico fuera del alcance de los niños.
- Identifique correctamente todas las piezas antes de montarlas
 - Nunca utilice su artículo si alguna de sus piezas está rota o falta
 - Si surge algún problema, póngase en contacto con nuestro Servicio Postventa
 - Las instrucciones del fabricante deben seguirse en todo momento
 - Cuidado: Limpiar con un paño suave y seco. En caso de manchas más grandes, frote cuidadosamente con una esponja no abrasiva ligeramente humedecida.
 - Evite el riesgo de incendio no colocando los muebles cerca de fuentes de ignición u objetos calientes.
 - No saltar sobre la cama.



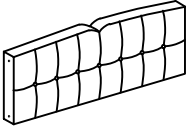
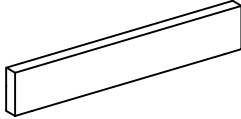
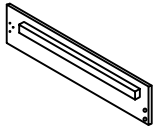
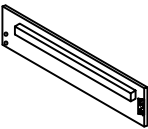

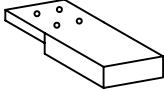
Detailansicht
Detail View
vue détaillée

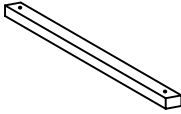

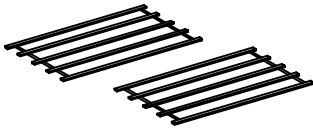

Stückliste Part List Liste des pièces

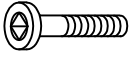
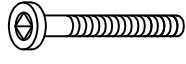
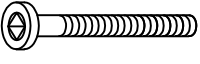
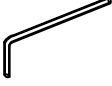
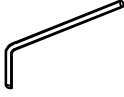
1		2		3	
Headboard - 1pc		Footboard - 1pc		Side Rail (L/R) - 2pcs	
4		5		6	
Side Rail (L/R) - 2pcs		Side Wing (L/R) - 2pcs		Side Rail Support Leg - 2pcs	
7		8		9	
Support Leg - 4pcs		Center Rail - 2pcs		Footboard Leg - 2pcs	
10					
Slat 5 roll - 2pcs					

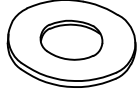
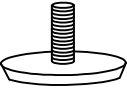
Hardwareliste Hardware List Liste du matériel

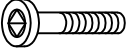
A 	B 	C 
M8x20mm (4pcs)	M6x30mm (8pcs)	M6x50mm (10pcs)
D 	E 	F 
M6x60mm (4pcs)	Allen key 65mm (1pc)	Allen key 70mm (1pc)
G 	H  M6	I  M6
Screw M4x32mm (20pcs)	Spring Washer (10pcs)	Flat Washer (18pcs)
J 		
Adjuster (4pcs)		

B 	C 	D 
M6x30mm (8pcs)	M6x50mm (10pcs)	M6x60mm (4pcs)

DE:Bitte beachten Sie, dass die Formen der Schrauben B und C und D ähnlich sind. Bitte installieren Sie entsprechend der Anleitung und unterscheiden Sie sie!

UK:Please note that the shapes of screws B and C and D are similar. Please install according to the instructions and distinguish them!

FR:Notez que les vis B et C et D ont des formes similaires. Veuillez les installer en suivant les instructions pour les séparer!





DE: Vor dem Einbau die Schrauben in die Löcher stecken und festziehen, aber nicht bis 100%, 70% bis 80% anziehen reicht aus. Schließlich, nachdem alle Schrauben installiert sind, ziehen Sie alle Schrauben auf 100%.

Wenn Sie auf diese Probleme stoßen, wie z. B. Fehlausrichtung der Löcher oder Unfähigkeit, bestimmte Teile zu installieren, überprüfen Sie bitte, ob die Schrauben korrekt verwendet werden und passen Sie die Dichtigkeit der Schrauben an.

UK: Before installation, insert the screws into the holes and tighten them, but do not tighten them to 100%, 70% to 80% is sufficient. Finally, after all screws are installed, tighten all screws to 100%. If you encounter these issues, such as if the holes cannot be aligned or some parts cannot be installed, please check if the screws are used correctly and adjust the tightness of the screws.

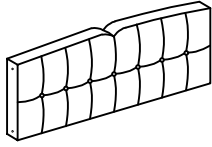
FR: Insérer la vis dans le trou avant la fin de l'assemblage, serrer la vis, mais ne pas serrer à 100%, 70% ~ 80% est correct. Enfin, une fois que toutes les vis sont bien serrées, toutes les vis sont serrées à 100%.

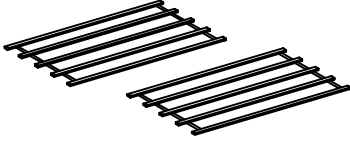
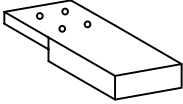
Si vous rencontrez ces problèmes, par exemple si les trous ne sont pas alignés ou si certaines pièces ne peuvent pas être montées, vérifiez que les vis sont utilisées correctement et Ajustez leur serrage.

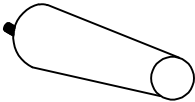
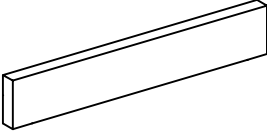
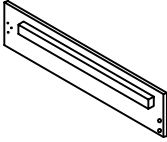
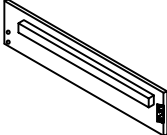
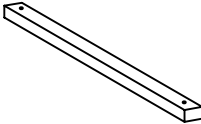
Carton	Name	No	Part
1	Headboard	1	
	Side Wing	5	
	Slat	10	
	Side Rail Support Leg	6	
	Support Leg	7	
	Footboard Leg	9	
2	Footboard	2	
	Side Rail	3	
	Side Rail	4	
	Center Rail	8	

Schritt 1:

Step 1:

Étape 1:

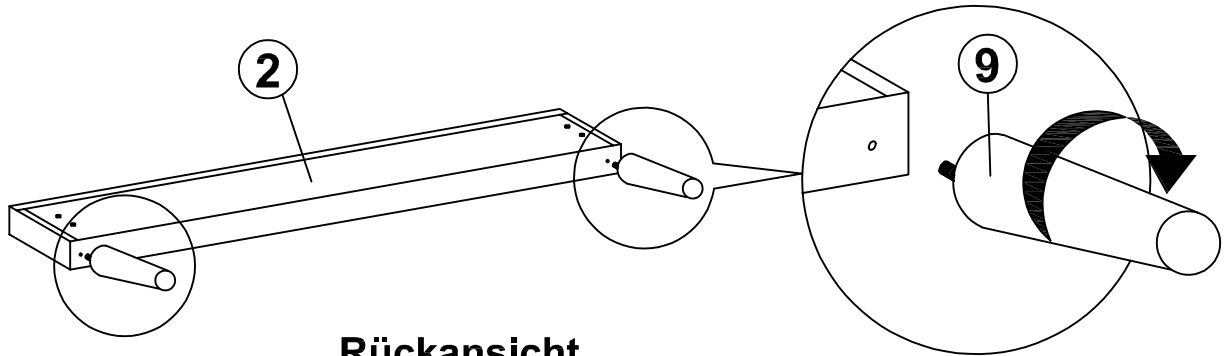



**Rückansicht
Back view
Vue arrière**

Schritt 2:



Step 2:

Étape 2:

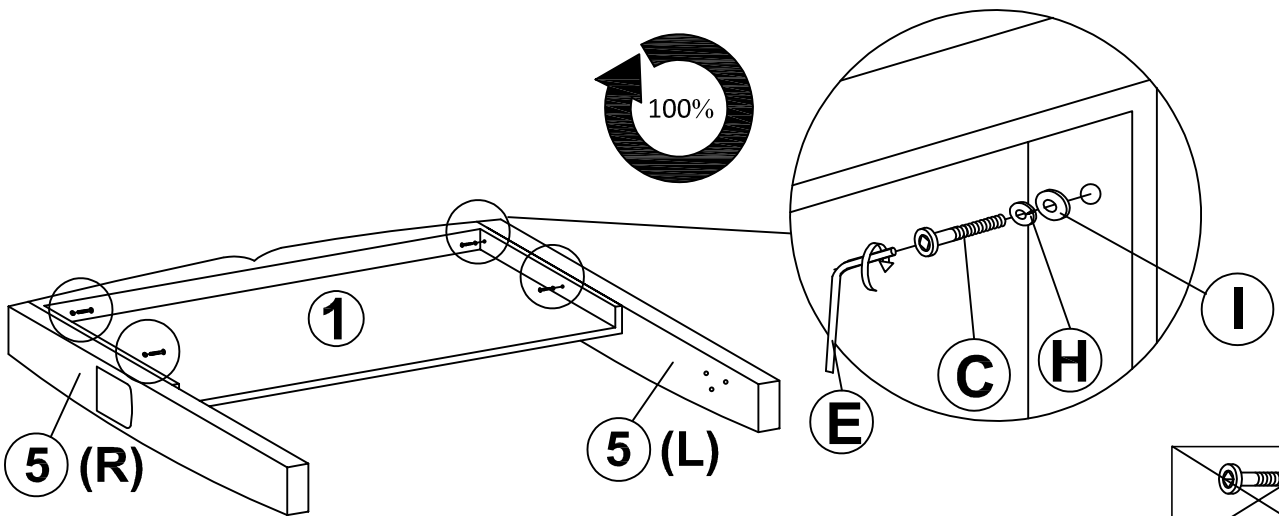
 M6x50mm	 Spring Washer	 Flat Washer
Ⓢ x (4pcs)	Ⓜ x (4pcs)	Ⓛ x (4pcs)



**Rückansicht
Back view
Vue arrière**



 M6x30mm
 M6x50mm
 M6x60mm

Schritt 3:

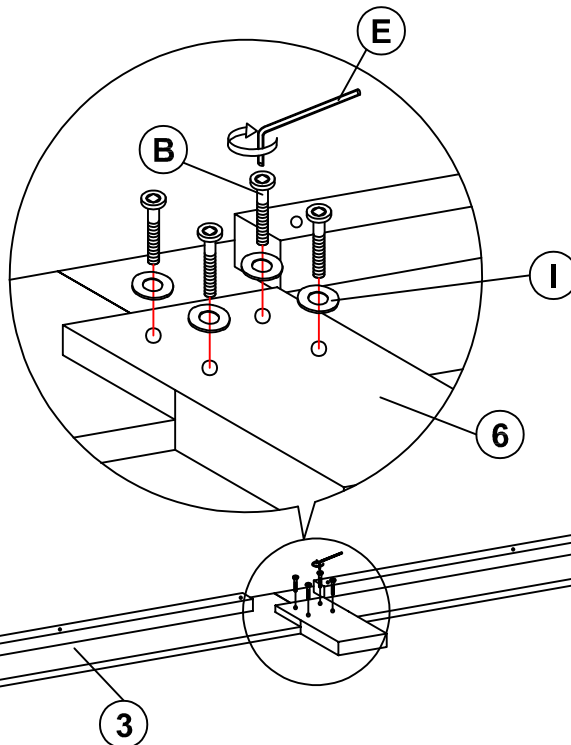
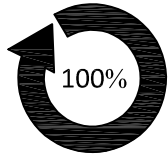

Step 3:

Étape 3:



 M6x30mm	 Flat Washer
(B) x (8pcs)	(I) x (8pcs)

x2

 M6x30mm
 M6x50mm
 M6x60mm

Schritt 4:

Step 4:

Étape 4:

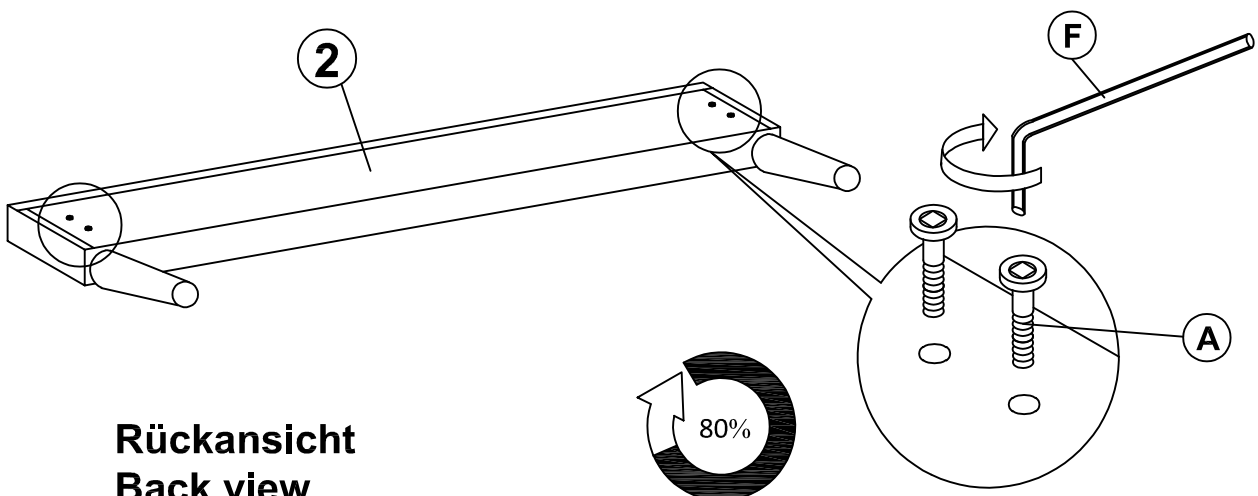



Rückansicht
Back view
Vue arrière

 M8x20mm
(A) x (4pcs)



Schritt 5:

Step 5:

Étape 5:

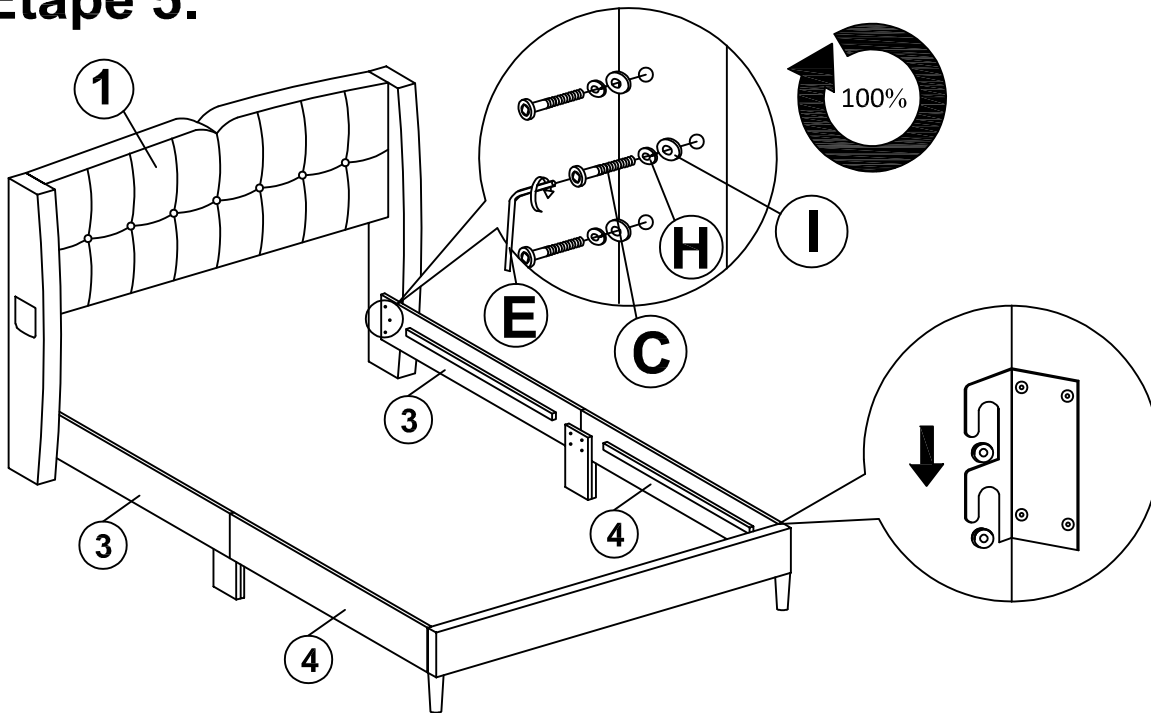
 M6x50mm	 Spring Washer	 Flat Washer
Ⓒ x (6pcs)	Ⓗ x (6pcs)	Ⓘ x (6pcs)

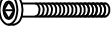

 M6x30mm
 M6x50mm
 M6x60mm

Schritt 6:

Step 6:

Étape 6:

 M6x60mm
Ⓓ x (4pcs)

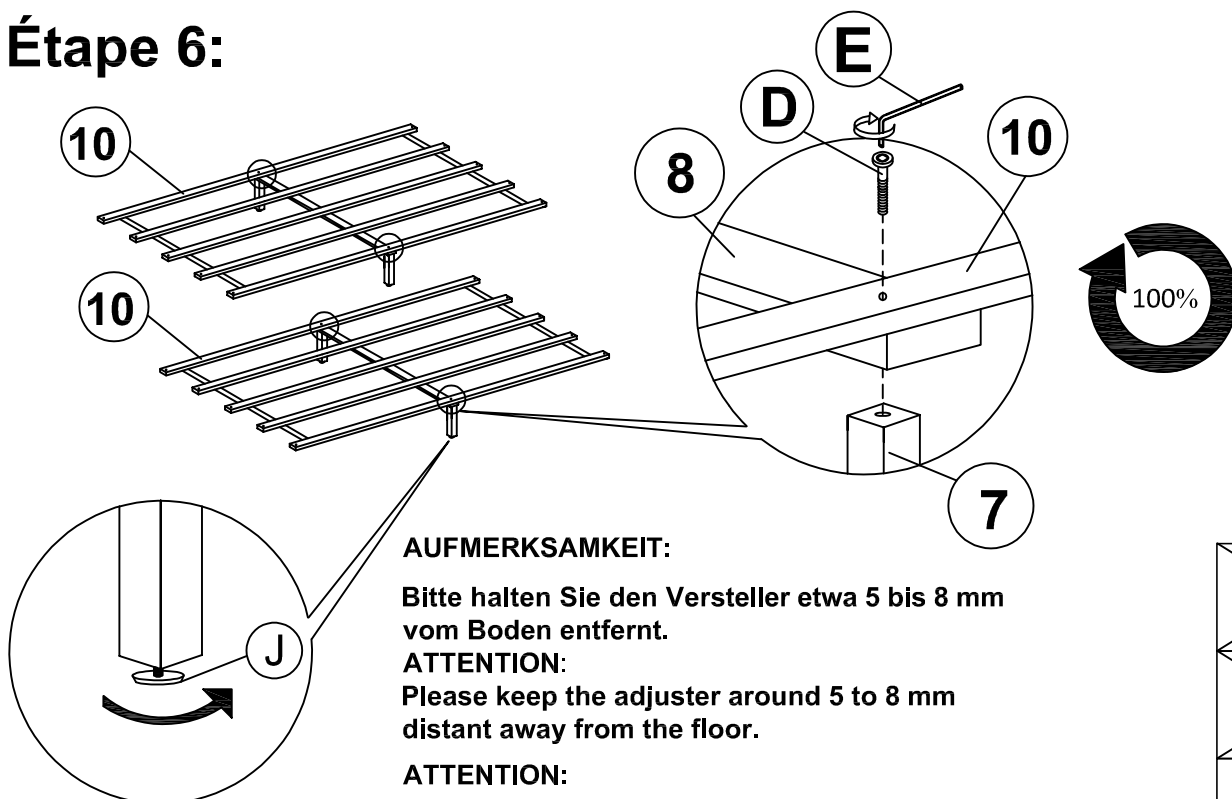

AUFMERSAMKEIT:



Bitte halten Sie den Versteller etwa 5 bis 8 mm vom Boden entfernt.

ATTENTION:

Please keep the adjuster around 5 to 8 mm distant away from the floor.

ATTENTION:

Veuillez garder le dispositif de réglage à environ 5 à 8 mm du sol.

 M6x30mm
 M6x50mm
 M6x60mm

Schritt 7:

Step 7:

Étape 7:



M4x32mm

ⓐ x (20pcs)

