

164.00 毫米



63.00 毫米

TheraFace PRO

TABLE OF CONTENTS

1. Product Overview

TheraFace PRO	2
---------------	---

2. Intended Use

Percussive Therapy	3
TheraOne Conductive Gel	4
Microcurrent Ring	4
Cleansing Ring	4
LED Ring - RED Light	5
LED Ring - Blue Light	5
LED Ring - Red + Infrared Light	5

3. Getting To Know Your TheraFace PRO Device

Power Button	6
Percussive Therapy Button	6
Ring Button	6
Attachment Ring	6
LED Ring: Blue/Red/Red + IR	7
Microcurrent Ring	7
Cleansing Ring	7
Hot and Cold Rings	7
Percussive Therapy Attachments	8

4. Getting Started

Powering On	9
Switching Off	9
Automatic Shut Off	9
Basic getting started steps	9

5. Using the TheraFace PRO

Percussive Therapy Feature	10
LED Treatment	10
Microcurrent Treatment	11
Microcurrent Primer: TheraOne Conductive Gel	11
After Skin Treatment	12
Device Maintenance	12
Care and Cleaning	12
Charging the TheraFace PRO	13

6. Important Safety Information

Background	13
General TheraFace PRO Use	14
Microcurrent Ring Attachment	14
LED Ring Attachment	15
Percussive Therapy Attachments	16
Cleansing Ring Attachment	16
Hot Ring Attachment	17
Cold Ring Attachment	17
Additional Unit Warning	18
Labels	20
Product Specifications	20
Safety, EMC & Bio-compatibility	22
FCC compliance statement	22
Manufacturer's Declaration	23
Manufacturer Information and Warranty	26

Product Overview

TheraFace PRO

An advanced solution for better facial wellness.

The TheraFace PRO is a 4-in-1 handheld device that takes facial wellness to the next level by helping to reduce tension, relax facial muscles, and achieve healthier-looking skin by gently stimulating the face. It includes microcurrent, blue, red, and red+infrared light LED, and cleansing treatments, allowing you to customize your facial therapy in one easy-to-use versatile device. Use the variety of treatment rings to help lift, tone, rejuvenate, and deep clean. The TheraFace PRO is your all-in-one solution for optimal health and wellness for the face.

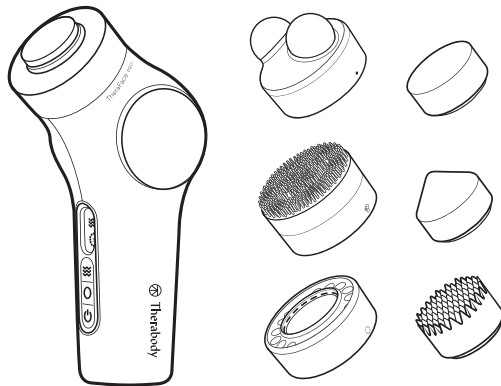

Intended Use

The TheraFace PRO is intended to help reduce tension, relax facial muscles, and achieve more beautiful skin by gently stimulating the face. The variety of treatment rings are intended to help lift, tone, rejuvenate, and deep clean.

Percussive Therapy

Percussive therapy, now optimized for the face. Facial massage to reduce tension and relax facial muscles.



Lift



Tone



Rejuvenate



TheraOne™ Conductive Gel

A primer gel intended to be used with the TheraFace PRO device prior to starting the microcurrent treatment to ensure the treatment is delivered safely and effectively

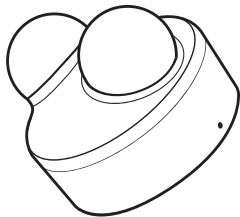

Microcurrent Ring

Microcurrent firms and tightens the skin. Microcurrent improves muscle tone and contour in the face/neck

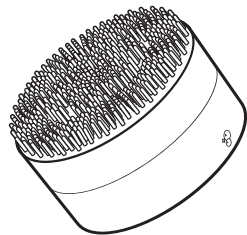

Cleansing Ring

Cleansing removes facial build up of dirt, oil, and debris

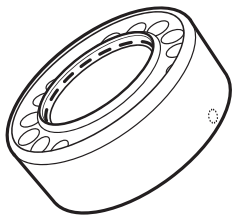

LED Ring

LED Ring: RED Light

Red Light **is intended to** reduce periorbital wrinkles (the wrinkles around the eyes)

LED Ring: Blue Light

Blue Light **is intended to** reduce mild to moderate acne

LED Ring: Red + Infrared Light

Red + Infrared Light **is intended to** reduce periorbital wrinkles (the wrinkles around the eyes) and provides therapeutic warming to temporarily reduce pain and discomfort

**Blue Light is not intended to treat or reduce severe acne*



Getting To Know Your TheraFace PRO Device

- A Power Button**
 - Powers the device ON / OFF
- B Percussive Therapy Button**
 - Controls the Percussive Attachment
- C Ring Button**
 - Controls the Attachment Ring
- D Attachment Ring**
 - Magnetic connection to the device and can be removed by pulling
 - All the Attachment Rings have only one correct position

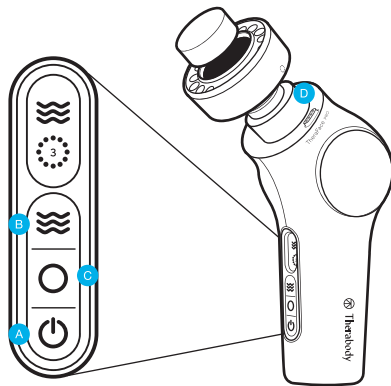

E LED Ring: Blue/Red/Red+IR

- Magnetic connection to the device and can be removed by pulling
- The LED treatment is delivered through the LED Ring

F Microcurrent Ring

- Magnetic connection to the device and can be removed by pulling
- The Microcurrent treatment is delivered through the Microcurrent Ring

G Cleansing Ring

- Magnetic connection to the device and can be removed by pulling
- All cleansing is delivered through the Cleansing Ring

H Hot and Cold Rings (sold separately)

- Magnetic connection to the device and can be removed by pulling
- Delivers the option of 3 Cold and 3 Hot settings

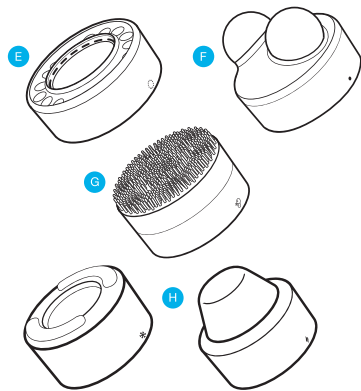

I Percussive Therapy Attachments

- Magnetic connection to the device and can be removed by pulling
- All the Attachment Rings have only one correct position

J Flat

- General use for the entire face, neck and chest

K Cone

- More precise treatment for targeted areas such as around the eyes, nasolabial lines and pressure points

L Micro-point

- Maximize circulation for larger areas such as the forehead, cheeks and chest

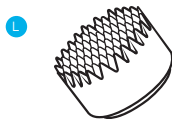

Getting Started

Powering on the TheraFace PRO device

Push and hold the ON/OFF button to power on the device and the OLED screen will turn on.

Switching Off

Push and hold the ON/OFF button again to switch the device off and the OLED screen will be off.

Automatic Shut Off

If the device is not manually powered off by pressing the Power button, the device will automatically shut off after 10 minutes of inactivity.

Basic getting started steps:

1. Start with a clean, dry face
2. Select and attach your desired attachment ring
3. Turn on the device
4. Choose your settings
5. Get started

Note: Make sure you turn off the power on the device before removing the rings.

Using the TheraFace PRO

Start by washing your face completely and rinse twice to remove residue. Allow skin to dry completely before starting treatment. Be sure to visit therabody.com for treatment protocols and instructional videos.

Note: The TheraFace PRO device will make a beeping sound every 15 seconds. This will help you track the time within each treatment and will also inform you if a treatment has been disconnected or is completed.

- 1 beep = timed feedback every 15 sec so you can time their protocols better
- 2 beeps = the LED, Microcurrent, Hot, or Cold treatment has been accidentally disconnected
- 3 beeps = the LED, Microcurrent, Hot, or Cold treatment is over

A. Percussive Therapy Feature

1. Select and attach the desired percussive therapy attachment
2. Once attached to the TheraFace PRO, turn ON the TheraFace PRO device by pressing the Power Button for 2 seconds.
3. Turn on the percussive feature by pressing the percussive button once.
4. To toggle between the 3 speed options (1750, 2100 and 2400 rpm), press the percussive button again.
5. To stop the percussive treatment, press the percussive button a third time.

Note:

- Can be combined with the Cold Ring* - (**Hot and Cold Rings sold separately*)
- Cannot be combined with the Microcurrent Ring, Hot Ring, LED Rings and Cleansing Ring

B. LED Treatment

1. The LED ring has 3 light therapy wavelength options: red, blue and red+infrared.
2. To start using the LED therapy mode, attach the LED ring to the TheraFace PRO device.
3. Turn ON the TheraFace PRO device by pressing the Power Button for 2 seconds.
4. Then, turn ON the LED ring by pressing the Attachment Ring button.
5. To toggle between light options (blue, red and red+infrared), press the Attachment Ring button again.
6. The TheraFace PRO LED ring has a proximity sensor system, and will only reach full light intensity (brightness) once the device is placed at the right distance from your face (0.5 inches), reducing glare in the interim. Avoid direct skin contact.
7. To turn off the LED ring, toggle to the Red+IR light mode and press the Attachment Ring Button one more time or power off the TheraFace PRO device by pressing the Power Button for 2 seconds.

Warning: Do not place the LED Ring directly on the skin. Keep the LED Ring approximately **0.5 inches** away from the skin.

C. Microcurrent Treatment

1. Remove any percussive therapy attachment before attaching the Microcurrent Ring.
2. Prior to starting the microcurrent treatment, apply the TheraOne™ Conductive Gel to your clean, dry face or treatment area to ensure the treatment is delivered correctly.
3. Attach the Microcurrent Ring to the TheraFace PRO device.
4. Once attached to the TheraFace PRO, turn ON the TheraFace PRO device by pressing the Power Button for 2 seconds.
5. Turn on the microcurrent treatment by pressing the ring button once.
6. To adjust the intensity level to your comfort, press the ring button once to toggle between the 3 intensity options.
7. To stop the microcurrent treatment, press the ring button a third time.

PRO Tip: When using the Microcurrent Ring, slowly glide the device using light to medium pressure, keeping both spheres on the face at once. A microcurrent protocol of 5-8 minutes can be completed once per 24-hour period. Be sure to visit therabody.com for treatment protocols and instructional videos.

- Note:**
- There is a preset shut off time of 8 minutes
 - Cannot be combined with the percussive therapy attachments
 - While the Microcurrent Ring will work with any conductive gel, we recommend the TheraOne™ Conductive Gel if available in your market.

Warning: When using the TheraFace PRO with the Microcurrent Ring, a microcurrent primer is required. Do NOT use the Microcurrent Ring on the midline of the neck or eye area.

D. Microcurrent Primer: TheraOne Conductive Gel

The TheraOne™ Conductive Gel is a primer intended to be used with the TheraFace PRO device prior to starting the microcurrent treatment to ensure the treatment is delivered safely and effectively.

Directions:

1. Start with a clean, dry face.
2. Apply a mask-like layer of the conductive gel to all treatment areas of the face and neck.
3. Following treatment with the microcurrent ring, rinse off and apply your favorite moisturizer.

Warnings: Use only as directed. Avoid eye contact. Prior to starting the microcurrent treatment, test by applying a small amount of the TheraOne Conductive Gel on a small patch of skin first. Skin may absorb gel during microcurrent session; reapply if needed to ensure even glide of device on the skin.

If you already use a toner, serum, moisturizer, and/or SPF, then apply in this order following the completion of any TheraFace PRO protocol:

1. Toner: Use one cotton pad with toner applied sweeping gently across the face, avoiding the eye area and concentrating on the nose, nasal fold, and chin
2. Serum: Apply serum
3. Moisturizer: Apply moisturizer
4. SPF: Apply SPF only in the morning or daytime hours

TheraFace PRO Device After Care & Cleaning

After Skin Treatment

Clean your face with a warm, damp washcloth.

Device Maintenance

The following maintenance instructions are important to ensure that your device continues to work as it was designed. Failure to follow these instructions may cause your device to stop working.

Care and Cleaning

Visually inspect the TheraFace PRO device and attachment rings for any obvious signs of debris build-up. Wipe your device and attachment rings down with a damp cloth or alcohol-free cleansing wipe. After cleaning, allow the device and attachment rings to dry thoroughly before storing or beginning another treatment protocol. A properly cleaned device should have no visible signs of debris or moisture.

Note: This product is not waterproof, only clean with a damp cloth or alcohol-free cleansing wipe by wiping the device and attachment rings. Do not submerge the device in water or clean it under running water (other than the Cleaning Ring). Do not allow the device to come into contact with any corrosive solutions, which would damage appearance and function. Store the device in a cool and dry place (Temperature: 0°C/32°F - 40°C/104°F Relative humidity: 10-95% RH). Do not store the device or battery where temperatures may exceed 40°C/104°F, such as in direct sunlight or in a vehicle.

Charging the TheraFace PRO

- The TheraFace PRO is USB-C enabled with the connector at the bottom of the device.
- The TheraFace PRO includes a USB-C to USB-A cable.
- You can plug the device into any standard USB adapter.
- The TheraFace PRO allows for fast-charging if charged with a USB-C adapter.

Note: Make sure the charger is from a certified manufacturer and it hasn't suffered any structural damage. The TheraFace PRO device will not work while charging.

TheraFace PRO Warnings and Guidance (Precautions and Contraindications)

Background

This device is intended to be used on the face, neck, and upper chest regions of the body. If you have any specific medical conditions or concerns, please consult your physician before using this product. There will be times when it is advisable to modify how devices are used (precautions) or times when it is not appropriate to use certain devices (contraindications). The following document highlights these for each modality or treatment attachment included with the TheraFace PRO device as of the date of printing. For up-to-date information, please visit us online.

Important Safety Information

General TheraFace PRO Use

Read the full Warnings and Guidance prior to using the TheraFace PRO.

This device is contraindicated against and should not be used by or on anyone with a history of epilepsy, seizures or cardiopathy. The TheraFace PRO is not recommended for anyone with an electronic implanted device (such as a pacemaker), cardiac, an electronic implanted device, cardiac arrhythmia, tumors, or acute episodes of inflammatory diseases. The device is not recommended for those who have arteriosclerosis, thromboses or implants in the body region being treated. Dental implants should be firmly anchored before using the device. Do not use the device on the eyes, eyelids, or the area immediately surrounding the eye (Periorbita area). The device should not be used if you have dark brown or black spots, such as large freckles, birthmarks, moles or warts, on the area to be treated. The device is not recommended if you have eczema, psoriasis, lesions, open wounds or active infections other than mild to moderate acne, such as cold sores, in the area to be treated. Wait for the infected area to heal before using the device. The device should not be used if you have abnormal skin conditions caused by diabetes or other systemic or metabolic diseases. It is not recommended to use this device if you have a history of herpes outbreaks in the area of treatment, unless you have consulted with your physician and have received preventive treatment before using the device.

Please consult your physician prior to use if you are pregnant and/or nursing.

Immediately stop using the device at the first sign of discomfort.

The device is not recommended for anyone under the age of 18 without adult supervision and should be kept out of reach of children. If you have any medical concerns, are taking any medications that cause light sensitivity, or have had any facial surgery or other surgical procedures, please consult your doctor before using the device.

Microcurrent Ring Attachment

These recommendations are derived from consultation with medical experts and the published research in regards to precautions and contraindications and are as of the date of printing. For up-to-date information, please visit us online.

When using the device with the microcurrent treatment, a microcurrent conductive gel primer **is required**. Prior to starting the microcurrent treatment, test by applying a small amount of the conductive gel on a small patch of skin.

Precautions

- Recent injury, surgery, or facial treatment such as neurotoxin, dermal filler, microneedling, laser, and/or chemical peel until skin has fully healed
- Do not use during a breakout from Herpes Simplex Virus

- Do not use over facial hair; facial hair must be shaved prior to use as hair can interfere with the conductivity
- Do not use if you suffer from any heart condition
- Do not use directly over center of neck (bone), specifically avoiding the thyroid
- Do not use on breast area
- Do not use across your chest
- Do not use on groin area
- Do not use directly on the eyes, eyelids, or the area immediately surrounding the eye (Periorbita area).
- Do not apply to broken skin
- Do not use on children

Contraindications

The following are circumstances where the potential risks may outweigh the benefits. Consult a medical professional before use.

- Skin rash, open wounds, blisters, local tissue inflammation, infections, bruises, or tumors
- Melasma or hyperpigmentation (especially if exacerbated by mild warmth)
- Pacemaker or other implanted electronic devices
- Epilepsy
- Pregnancy
- Cancer/tumors
- Thrombosis

- Phlebitis
- Metal plates or pins in the application area
- Implanted defibrillators/ stimulators

LED Ring Attachment (Red LED, Red+IR LED, and Blue LED Therapies)

These recommendations are derived from consultation with medical experts and the published research in regards to precautions and contraindications as of the date of printing. For up-to-date information, please visit us online.

Precautions

- Recent injury, surgery, or facial treatment such as neurotoxin, dermal filler, microneedling, laser, and/or chemical peel until skin has fully healed.
- Current breakout from Herpes Simplex Virus
- For facial hair: Use LED over facial hair, following the pattern of hair growth (typically in a downward motion)
- Do not apply directly to the eyeball/eyelid
- Do not apply to broken skin
- Do not apply retinol before use of red LED light

Contraindications

The following are circumstances where the potential risks may outweigh the benefits. Consult a medical professional before use.

- Skin rash, open wounds, blisters, local tissue inflammation, infections, bruises, or tumors
- Melasma or hyperpigmentation (especially if exacerbated by mild warmth)
- Pregnancy/nursing
- Abnormal sensations (ex. numbness)
- Cancer/tumors
- Epilepsy
- Cardiopathy (heart disease)
- Photo allergy or disorder (ex. Lupus, porphyria)
- Medications that cause light sensitivity
- Medications for severe acne
- Extreme sensitivity to light
- Melasma or hyperpigmentation (especially if exacerbated by mild warmth)
- Suspicious lesions or skin cancer—please visit your physician
- If taking or using any retinol or sun-sensitive medications or products or benzoyl peroxide do not use infrared light

Percussive Therapy Attachments (Flat, Cone, Micro-point)

These recommendations are derived from consultation with medical experts and the published research in regards to precautions and contraindications as of the date of printing. For up-to-date information, please visit us online.

Precautions

Due care is required in these circumstances and the use of the devices may need to be modified (such as attachment used, the force applied, the position of the body, avoidance of use in direct contact with an area, etc.). Where appropriate or if you have any concerns, seek the advice of a medical professional.

- Recent injury, surgery, or facial treatment such as neurotoxin, dermal filler, microneedling, laser, and/or chemical peel until skin has fully healed.
- Current breakout from Herpes Simplex Virus
- Hypertension (controlled)
- Abnormal sensations (e.g., numbness)
- Sensitivity to pressure
- Medications that may alter sensations

- Do not apply directly to the eyeball/eyelid
- Do not apply to broken skin

Contraindications

The following are circumstances where the potential risks may outweigh the benefits. Consult a medical professional before use.

- Skin rash, open wounds, blisters, local tissue inflammation, infections, bruises, or tumors
- Melasma or hyperpigmentation (especially if exacerbated by mild warmth)
- Bone fracture or myositis ossificans
- Hypertension (uncontrolled)
- Acute or severe cardiac, liver, or kidney disease
- Neurologic conditions resulting in loss or altered sensation
- Direct application to the eyes or throat
- Bleeding disorders
- Recent surgery or injury
- Connective tissue disorders
- Peripheral vascular insufficiency or disease
- Medications that thin the blood or alter sensations
- Direct pressure over surgical site or hardware
- Extreme discomfort or pain
- Pacemaker, ICD, or history of embolism

Cleansing Ring Attachment

These recommendations are derived from consultation with medical experts and the published research in regards to precautions and contraindications as of the date of printing. For up-to-date information, please visit us online.

Precautions

- Recent injury, surgery, or facial treatment such as neurotoxin, dermal filler, microneedling, laser, and/or chemical peel until skin has fully healed.
- Current breakout from Herpes Simplex Virus
- If you have facial hair, use the cleansing ring following the pattern of hair growth (typically a downward motion) and/or make small circular motions if comfortable
- Do not apply directly to the eyeball/eyelid
- Do not apply to broken skin

Contraindications

The following are circumstances where the potential risks may outweigh the benefits. Consult a medical professional before use.

- Skin rash, open wounds, blisters, local tissue inflammation, infections, bruises, or tumors
- Melasma or hyperpigmentation (especially if exacerbated by mild warmth)

Hot Ring Attachment

These recommendations are derived from consultation with medical experts and the published research in regards to precautions and contraindications as of the date of printing. For up-to-date information, please visit us online.

Precautions

- Recent injury, surgery, or facial treatment such as neurotoxin, dermal filler, microneedling, laser, and/or chemical peel until skin has fully healed.
- Current breakout from Herpes Simplex Virus
- Do not apply directly on the eyeball/eyelid
- Do not apply to broken skin

Contraindications

The following are circumstances where the potential risks may outweigh the benefits. Consult a medical professional before use.

- Skin rash, open wounds, blisters, local tissue inflammation, infections, bruises, or tumors
- Melasma or hyperpigmentation (especially if exacerbated by mild warmth)

Cold Ring Attachment

These recommendations are derived from consultation with medical experts and the published research in regards to precautions and contraindications.

Precautions

- Recent injury, surgery, or facial treatment such as neurotoxin, dermal filler, microneedling, laser, and/or chemical peel until skin has fully healed.
- Current breakout from Herpes Simplex Virus
- For facial hair use Cold Ring as noted in standard protocol
- Do not apply on the eyeball/eyelid
- Do not apply to broken skin

Contraindications

The following are circumstances where the potential risks may outweigh the benefits. Consult a medical professional before use.

- Skin rash, open wounds, blisters, local tissue inflammation, infections, bruises, or tumors
- Melasma or hyperpigmentation (especially if exacerbated by mild warmth)
- Cold hypersensitivity/Cold urticaria
- Circulatory insufficiency

Additional Unit Warnings

When using the device, these basic precautions should always be followed:

1. **USE ONLY AS INSTRUCTED.** Use the device as described in the device User Manual only. Only use the recommended attachments, accessories, and replacement parts. Do not carry out any maintenance on your own.
2. **NOT FOR CHILDREN.** The device is not intended for use by young children or persons with reduced physical, sensory, or reasoning capabilities, or lack of experience and knowledge with how the device should be operated, unless they have been given supervision or instruction by a responsible person. Do not allow the device to be used as a toy. Children should be supervised to ensure that they do not play with the device.
3. **CHARGING LOCATIONS.** The device should be charged indoors in a well ventilated, dry location. Do not charge the device outdoors, in a bathroom, or within 10 feet (3.1 meters) of a bathtub or pool. Do not use the device or charger on wet surfaces and do not expose the charger to moisture, rain, or snow. Do not use the device in the presence of explosive atmospheres (gaseous fumes, dust, or flammable materials). Sparks may be generated, possibly causing a fire.
4. **DO NOT OVERCHARGE.** Do not leave the battery in the Charger for more than 1 hour after the battery has been fully charged. The battery includes a Theragun Protection system to avoid the risk of overcharging. However, overcharging may reduce its life over time
5. **DO NOT BURN OR INCINERATE THE DEVICE OR ITS BATTERIES.** The battery may explode, causing personal injury or damage. Toxic fumes and materials are created when the battery is burned.
6. **DO NOT CRUSH, DROP, OR DAMAGE THE DEVICE BATTERIES OR CHARGER.** Do not use a charger that has received a sharp blow, been dropped, run over, or damaged in any way.
7. **BATTERY CHEMICALS CAUSE SERIOUS BURNS.** Never allow the internal battery to come into contact with the skin, eyes, or mouth. If a damaged battery leaks chemicals, use rubber or neoprene gloves to dispose of it. If skin is exposed to battery fluids, wash with soap and water and rinse with vinegar. If eyes are exposed to battery chemicals, immediately flush with water for 20 minutes and seek medical attention. Remove and dispose of contaminated clothing.
8. **BATTERY CHEMICALS CAUSE SERIOUS BURNS.** Never allow the internal battery to come into contact with the skin, eyes, or mouth. If a damaged battery leaks chemicals, use rubber or neoprene gloves to dispose of it. If skin is exposed to battery fluids, wash with soap and water and rinse with vinegar. If eyes are exposed to battery chemicals, immediately flush with water for 20 minutes and seek medical attention. Remove and dispose of contaminated clothing.
9. **DO NOT SHORT CIRCUIT.** A battery will short circuit if a metal object makes a connection between the positive and negative contacts on the battery or the 16V connector. Do not place a battery near anything that may cause a short circuit, such as coins, keys, or nails in your pocket. A short circuited battery may cause fire and personal injury.







10. DO NOT OPERATE UNDER BLANKET AND PILLOW OR BETWEEN COUCH CUSHIONS. Excessive heating can occur and cause fire, electric shock, or injury.
11. STORING THE DEVICE & BATTERY. Store in a cool, dry place. Only charge the device when the ambient temperature is between 0°C/32°F - 40°C/104°F. Do not store the device or batteries where temperatures may exceed 40°C/104°F, such as in direct sunlight or in a vehicle.
12. DISPOSING OF BATTERIES. The TheraFace PRO lithium-ion batteries for the device are more environmentally friendly than some other types of batteries. Always dispose of device batteries according to federal, state, and local regulations. Contact a recycling agency in your area for recycling locations. Even discharged batteries contain some energy.
13. DO NOT DISASSEMBLE. Disassembly or incorrect reassembly may result in the risk of electric shock, fire, or exposure to battery chemicals. The warranty will be void if the device, batteries, or charger are disassembled or if any parts have been removed.
14. SERVICE. If the device, batteries, or charger is not working properly, has received a sharp blow, or has been dropped, damaged, left outdoors, or dropped into water, then do not use it. Do not attempt to repair or disassemble the device which may result in an electric shock or fire.
15. DO NOT USE WHILE BATHING OR IN THE SHOWER, TUB, OR SINK. Do not place or store the device or batteries where it can fall or be pulled into a tub or sink. Do not place in or drop into water or other liquid. Do not reach for an appliance that has fallen into or come into contact with water. Unplug immediately.
16. THERMAL LIMITER. The device has an automatic reset thermal limiter that shuts off the device to prevent overheating and fire.
17. DO NOT OPERATE the device where aerosol (spray) is being used or where oxygen is being administered.

SAVE THESE INSTRUCTIONS

Risk

1. Use the TheraFace PRO device and attachment rings only as described within this User Manual. The risks and dangers of using the TheraFace PRO device and attachment rings in any way other than specified in the provided User Manual are unknown and may result in negative side effects.
2. This TheraFace PRO device was not tested for use over the eye socket or eyelid so the risks are unknown.

Labels

NO.	SYMBOLS	DESCRIPTION
1		CE mark
2		the Restriction of Hazardous Substances
3		“WEEE (Waste Electrical and Electronic Equipment)”. The waste products should be handled legally.
4		Keep dry
5		FCC Federal Communications Commission
6		Please read the user manual before use
7		Type BF apply part.

Product Specifications

BASIC UNIT CHARACTERISTICS

Power Source	User supplied USB-A or USB-C adapter
Indicator Light	YES
Housing Materials	PC

ADDITIONAL FEATURES

Environment for operation	Temperature: 0 ~ 40° C Relative humidity: <93% RH
Environment for storage	Temperature: 0 ~ 40° C Relative humidity: 10~95% RH
Use atmospheric pressure	70-106Kpa

For Microcurrent Treatment:

Stimulated site	Face and neck
Number of modes	3
Output Intensity Level	4
Indicator Light	Yes, OLED display
Timer Range	5-8 minutes per day for 6 weeks
Housing Materials	Console: PC plastic

OUTPUT SPECIFICATION

Waveform	Pulsed Biphasic
Operating voltage	0-15.5V
Maximum power	24mW
Automatic shut-down	Yes

Maximum Output Voltage(+/- 10%)	210-280mV @500 Ohm 0.8- 1.2V @ 2k Ohm 4.75-5.2V @ 10k Ohm
---------------------------------	---

Maximum Output Current	420 μ A - 560 μ A @ 500 Ohm 400 μ A - 600 μ A @ 2k Ohm 475 μ A - 520 μ A @ 10k Ohm
Pulse Width	On 60ms / Off 60ms
Frequency	8.3Hz
Net Charge	N/A - Battery operated
Maximum Current Density	1.65mA/cm ² @ 500 Ohm
Maximum Power Density	1.36125mW/cm ² @ 500 Ω

FOR LED TREATMENT

Light wavelength	IR+Red:830nm \pm 10nm/633 \pm 10 nm Blue light:415nm \pm 10nm, Red light:633nm \pm 10nm
Power of light (mW//cm ²)	IR+Red 70 \pm 5%/60 \pm 5% Red light 60 \pm 5%, Blue light 45 \pm 5%

FOR PERCUSSIVE THERAPY

Percussive	1750, 2100 and 2400 rpm
Frequency	1750rpm :29.1Hz 2100rpm:35Hz 2400rpm:40Hz

Safety, EMC & Bio-compatibility

1. This device is Class II equipment with type BF applied part. It complies with Medical Electrical Safety Standards (IEC 60601-1).
2. This device is also compliant with Medical EMC Standard (IEC 60601-1-2).
3. All the user directly contacting materials for the main device housing and output contacts in this device are biocompatible for its intended use. They comply with biocompatibility standards ISO 10993-5 (Cytotoxicity) and ISO 10993-10 (Irritation and Sensitization).

The TheraFace PRO has been tested and found to comply with the electromagnetic compatibility (EMC) limits for medical device to IEC 60601-1-2: 2007. These limits are designed to provide reasonable protection against harmful interference in a typical medical installation.

CAUTION:

Do not apply the device near any devices with Electromagnetic Interference (EMI), such as cell phones, Magnetic Resonance Imaging (MRI), computerized axial tomography (CT), diathermy, Radio Frequency Identification (RFID), etc. or MR environment. EMI, RF devices or MR environment may affect the normal function of the device or would cause user injury.

FCC compliance statement

This device complies with Part 15 of the FCC Rules. Operation is subject to the following two conditions: (1) this device may not cause harmful interference, and (2) this device must accept any interference received, including interference that may cause undesired operation. Changes or modifications not expressly approved by the party responsible for compliance could void the user's authority to operate the equipment.

This equipment has been tested and found to comply with the limits for a Class B digital device, pursuant to Part 15 of the FCC Rules. These limits are designed to provide reasonable protection against harmful interference in a residential installation. This equipment generates, uses and can radiate radio frequency energy and, if not installed and used in accordance with the instructions, may cause harmful interference to radio communications. However, there is no guarantee that interference will not occur in a particular installation.

If this equipment does cause harmful interference to radio or television reception, which can be determined by turning the equipment off and on, the user is encouraged to try to correct the interference by one or more of the following measures:

- Reorient or relocate the receiving antenna.
- Increase the separation between the equipment and receiver.
- Connect the equipment into an outlet on a circuit different from that to which the receiver is connected.
- Consult the dealer or an experienced radio/TV technician for help.

MANUFACTURER'S DECLARATION - ELECTROMAGNETIC EMISSIONS

The TheraFace PRO is intended for use in the electromagnetic environments specified below. The customer or the user of the TheraFace PRO should ensure that it is used in such an environment.

EMISSIONS TEST	COMPLIANCE	ELECTROMAGNETIC ENVIRONMENT - GUIDANCE
RF emissions CISPR 11	Group 1	The TheraFace PRO uses RF energy only for its internal function. Therefore, its RF emissions are very low and are not likely to cause any interference in nearby electronic equipment.
RF emissions CISPR 11	Class B	The TheraFace PRO is suitable for use in all establishments, including domestic establishments and those directly connected to the public low-voltage power supply network that supplies buildings used for domestic purposes.
Harmonic emissions IEC 61000-3-2	Class A	
Voltage function / flicker emissions IEC 61000-3-2	Complies	

MANUFACTURER'S DECLARATION – ELECTROMAGNETIC IMMUNITY

The TheraFace PRO is intended for use in the electromagnetic environment specified below. The customer or the user of the TheraFace PRO should ensure that it is used in such an environment.			
IMMUNITY TEST	IEC 60601 TEST LEVEL	COMPLIANCE LEVEL	ELECTROMAGNETIC ENVIRONMENT - GUIDANCE
Electrostatic discharge (ESD) IEC 61000-4-2	±6kV contact ±8kV air	±6kV contact ±8kV air	Floors should be wood, concrete or ceramic tile. If floors are covered with synthetic material, the relative humidity should be at least 30%.
Electrostatic transient / burst IEC 61000-4-4	±2kV for power supply lines ±1kV for input/output lines	±2kV for power supply lines ±1kV for input/output lines	Mains power quality should be that of a typical commercial or hospital environment.
Surge IEC 61000-4-5	±1kV differential mode ±2kV common mode	±1kV differential mode ±2kV common mode	Mains power quality should be that of a typical commercial or hospital environment.
Voltage dips, short interruptions and voltage variations on power supply input lines IEC 61000-4-11	<5% U_T (>95% dip in UT) for 5 sec	<5% U_T (>95% dip in UT) for 5 sec	Mains power quality should be that of a typical commercial or hospital environment. If the user of the TheraFace PRO requires continued operation during power mains interruptions, it is recommended that the TheraFace PRO be powered from an uninterruptible power supply or a battery.
Power frequency (50/60 Hz magnetic field) IEC 61000-4-8	3 A/m	3 A/m	Power frequency magnetic fields should be at levels characteristic of a typical location in a typical commercial or hospital environment.
NOTE U_T is the a.c. mains voltage prior to application of the test level.			

IMMUNITY TEST	IEC 60601 TEST LEVEL	COMPLIANCE LEVEL	ELECTROMAGNETIC ENVIRONMENT - GUIDANCE
Conducted RF IEC 61000-4-6	3 Vrms 150kHz to 80MHz	3V	<p>Portable and mobile RF communications equipment should be used no closer to any part of the high Station, including cables, than the recommended separation distance calculated from the equation application to the frequency of the transmitter.</p> <p>Recommended separation distance Where p is the maximum output power rating of the transmitter in watts(W) according to the transmitter manufacturer and d is the recommended separation distance in metres(m).b</p> <p>Field strengths from fixed RF transmitters, as determined by an electromagnetic site survey, a should be less than the compliance level in each frequency range. b</p> <p>Interference may occur in the vicinity of equipment marked with the following symbol:</p>
Radiated RF	3V/m 80MHz to 2.5GHz	3V/m	<p>NOTE 1 At 80 MHz and 800 MHz, the higher frequency range applies.</p> <p>NOTE 2 These guidelines may not apply in all situations. Electromagnetic is affected by absorption and reflection from structures, objects and people.</p>

Field strengths from transmitters, such as base stations for radio (cellular/cordless) telephones and land mobile radios, amateur radio, AM and FM radio broadcast and TV broadcast cannot be predicted theoretically with accuracy. To assess the electromagnetic environment due to fixed RF transmitters, an electromagnetic site survey should be considered. If the measured field strength in the location in which the TheraFace PRO is used exceeds the applicable RF compliance level above. The TheraFace PRO should be observed to verify normal operation. If abnormal performance is observed, additional measures may be necessary, such as reorienting or relocating the high Station. Over the frequency range 150kHz to 80 MHz, field strengths should be less than 3V/m.

Recommended separation distances between portable and mobile
RF communications equipment and the EQUIPMENT or SYSTEM - For EQUIPMENT and SYSTEMS that are not LIFE - SUPPORTING

Recommended separation distances between
portable and mobile RF communications equipment and the high Station

The TheraFace PRO is intended for use in the electromagnetic environment specified below. The customer or the user of the TheraFace PRO should ensure that it is used in such an environment.

Rated maximum output of transmitter W	Separation distance according to frequency of transmitter		
	150 kHz to 80 MHz	80 MHz to 800 MHz	800 MHz to 2.5 GHz
0.01	0.12	0.12	0.23
0.1	0.38	0.38	0.73
1	1.2	1.2	2.3
10	3.8	3.8	7.3
100	12	12	23

For transmitters rated at a maximum output power not listed above the recommended separation distance d in meters (m) can be estimated using the equation applicable to the frequency of the transmitter, where P is the maximum output power rating of the transmitter in watts (W) according to the transmitter manufacturer.

NOTE 1 At 80 MHz and 800 MHz, the separation distance for the higher frequency range applies.

NOTE 2 These guidelines may not apply in all situations. Electromagnetic propagation is affected by absorption and reflection from structures, objects and people.

LIMITED WARRANTY

For full warranty information, please visit www.therabody.com/warranty. To request a copy of the warranty by mail, you may send a request to the following address:

Therabody - Warranty
Therabody, Inc. Attn: Customer Service
6100 Wilshire Blvd. Ste 200
Los Angeles, Ca. 90048

*Please note, this is not a return address or a retail location.
No Therabody products or packages will be accepted at this location.*

TheraFace PRO

by Therabody

Born in Los Angeles, CA.
Designed for every**body**.



@Therabody