

Art. Nr. 2841150

1/6

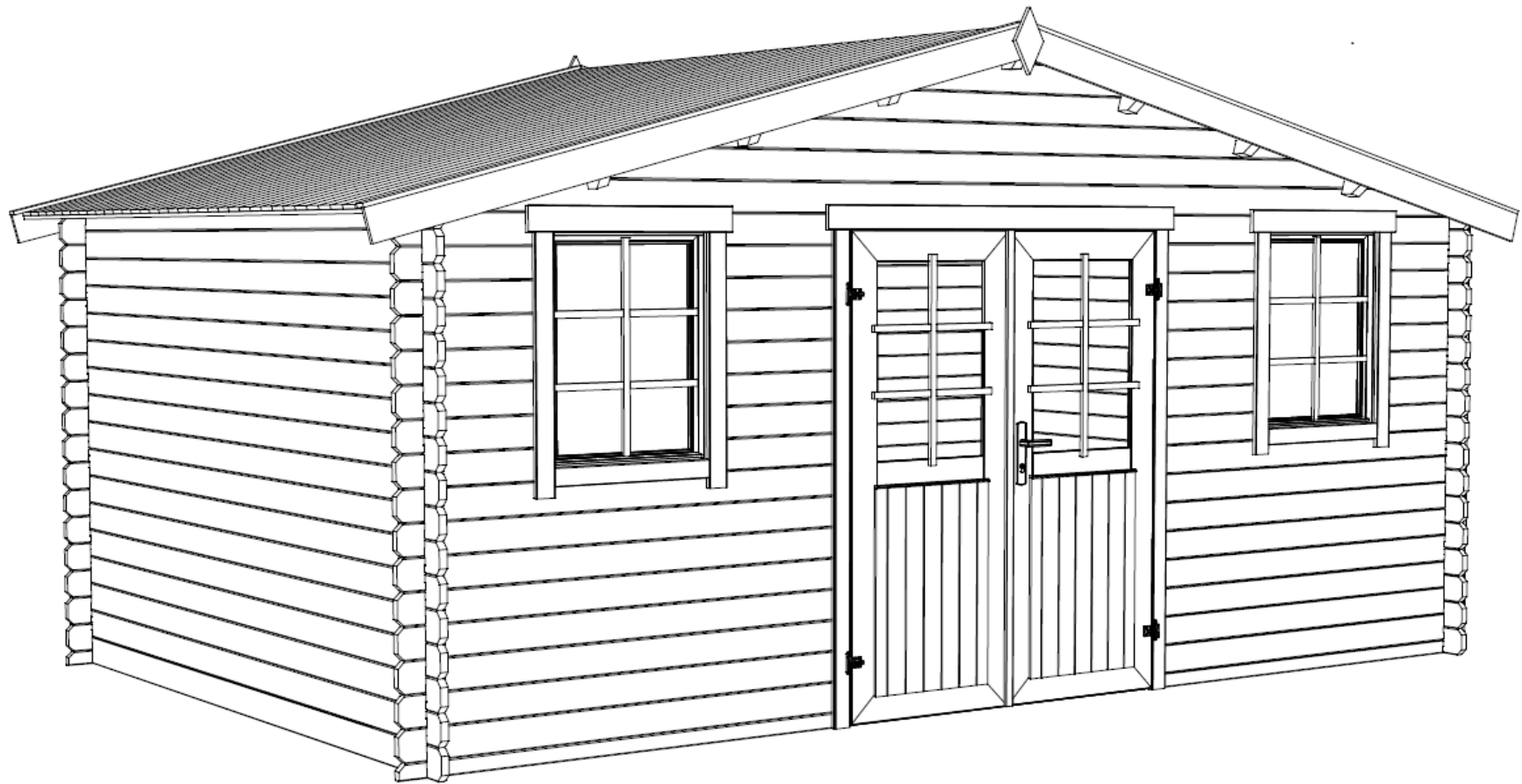

24.08.2017

Art.Nr. 2841150



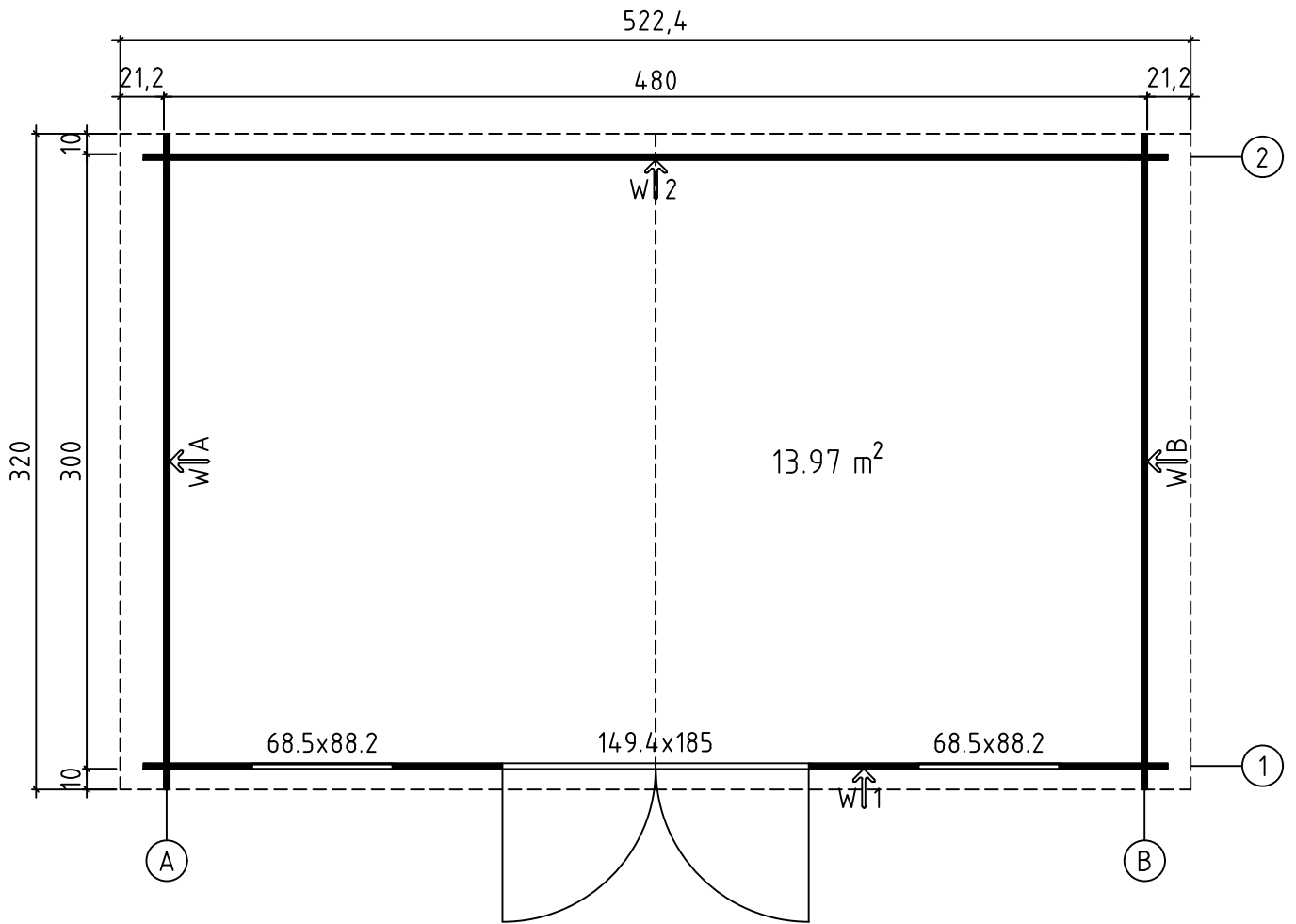

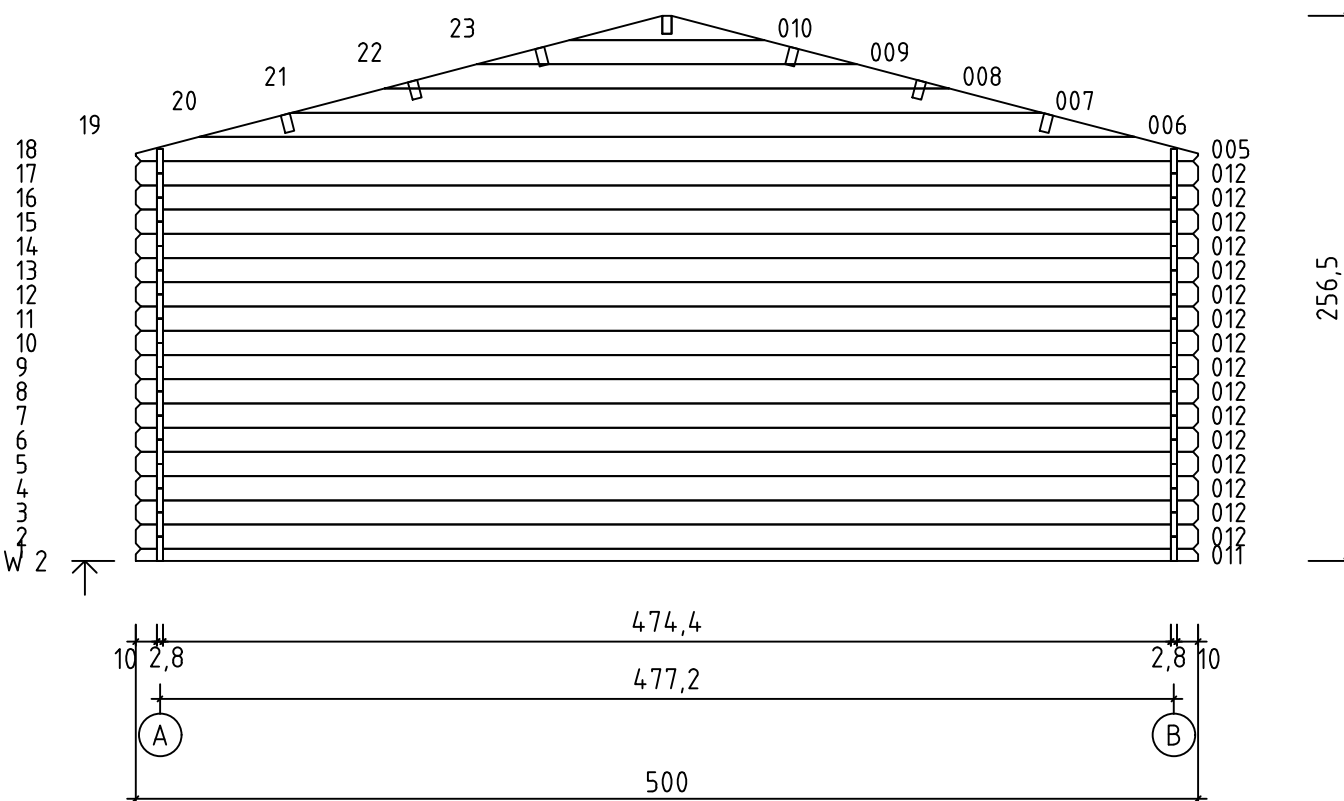
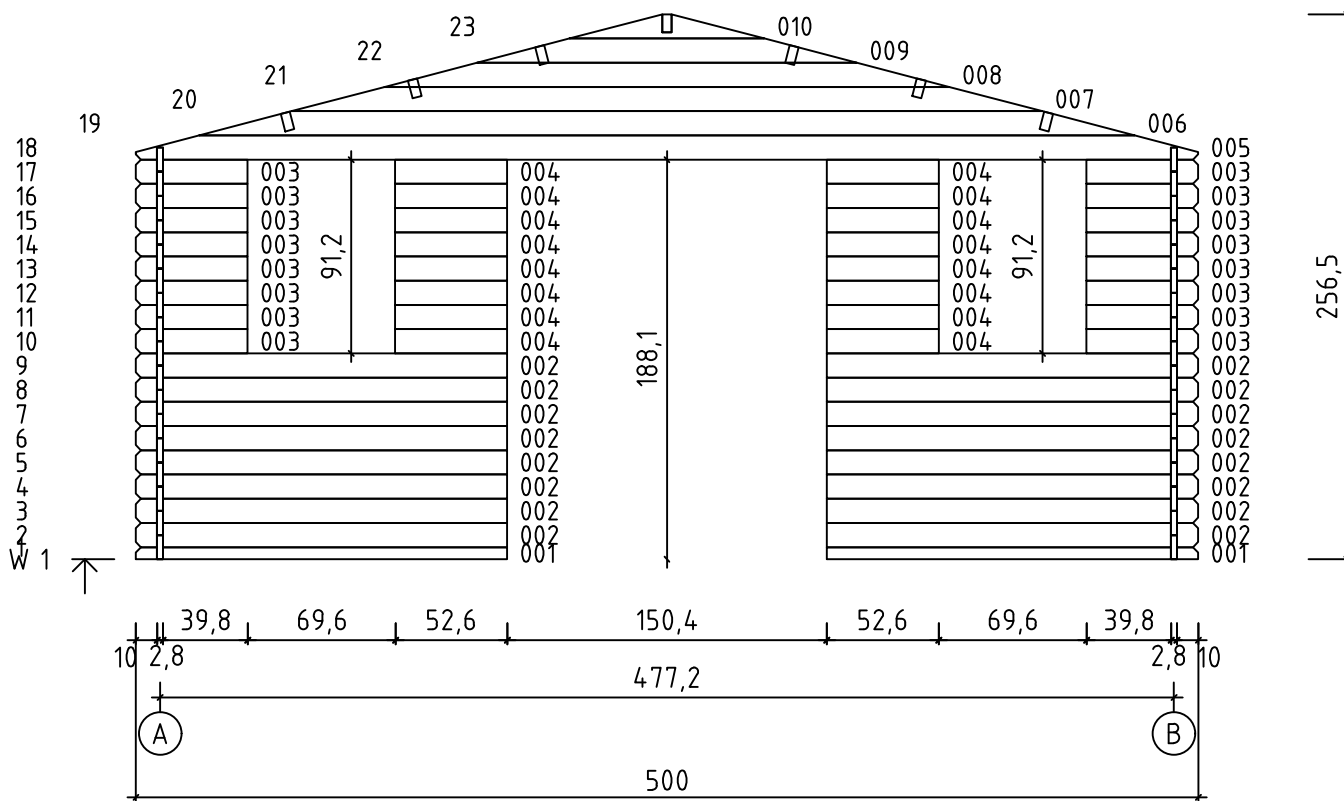



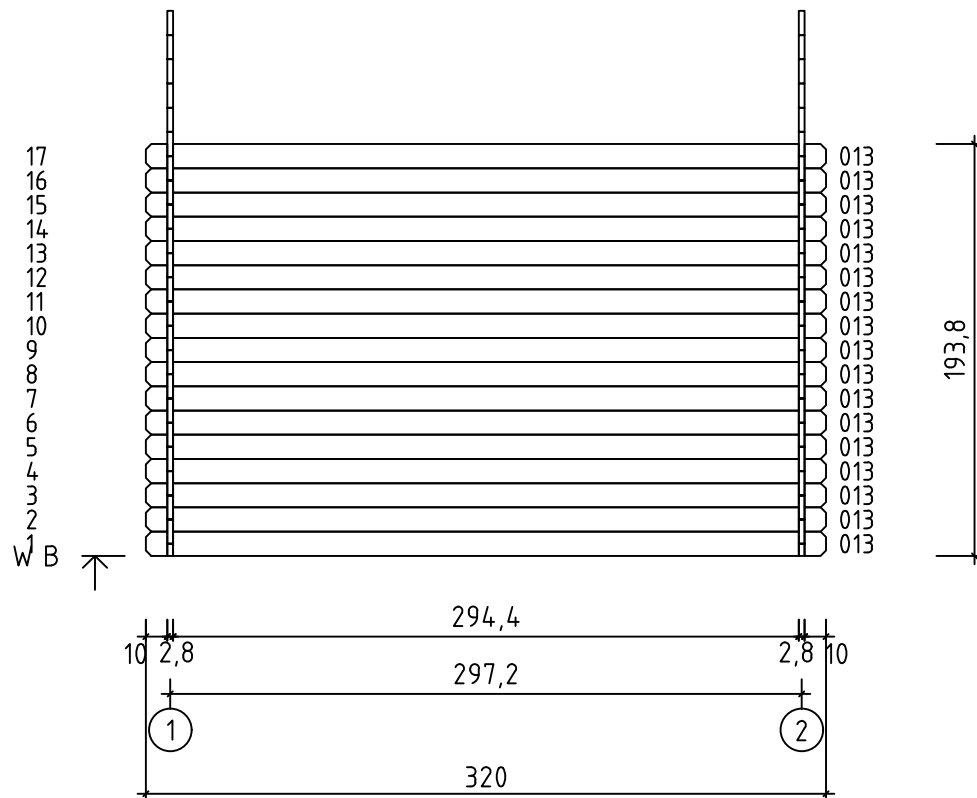
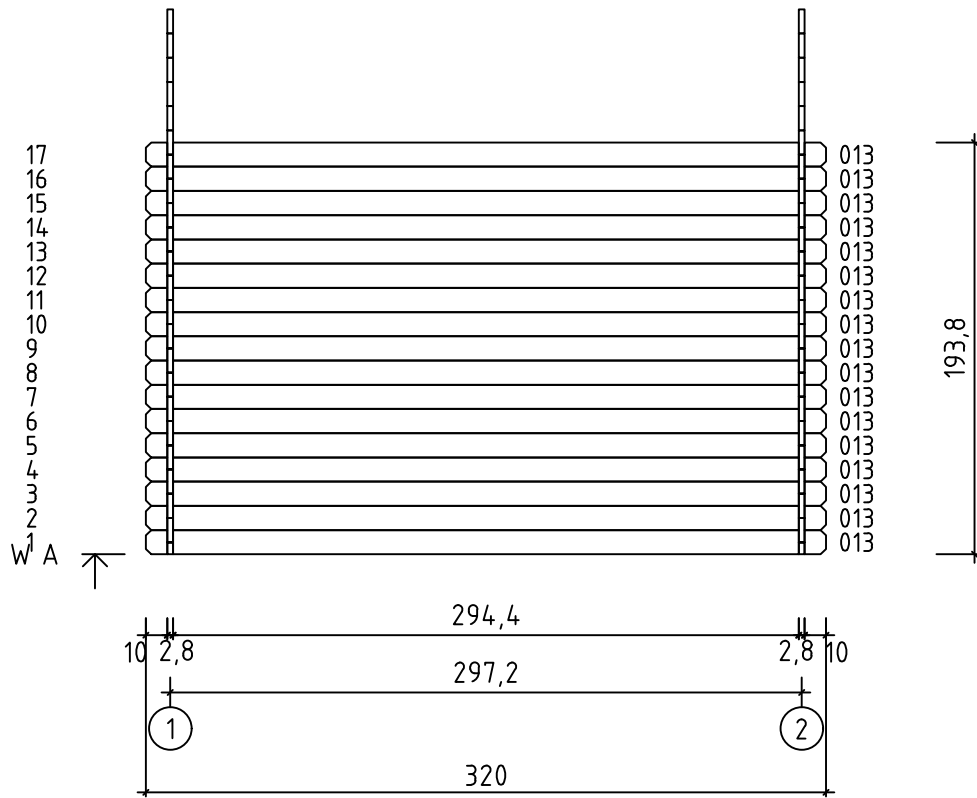

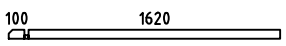
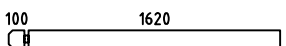

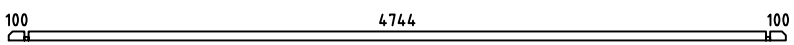
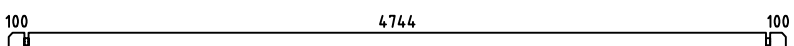
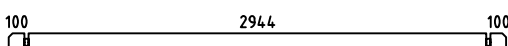
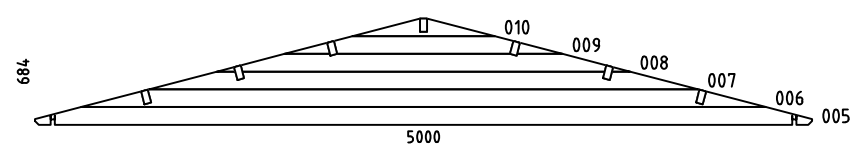
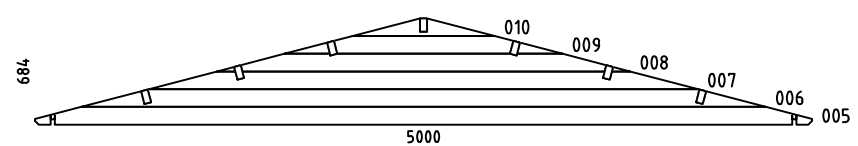
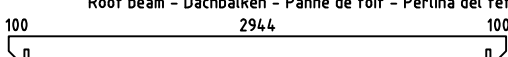
Groundplan - Grundplan - Plan de masse - Planimetria - Plattegrond - Põhiplaan



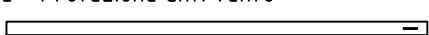
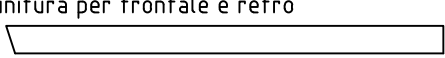





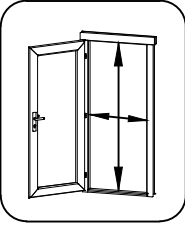
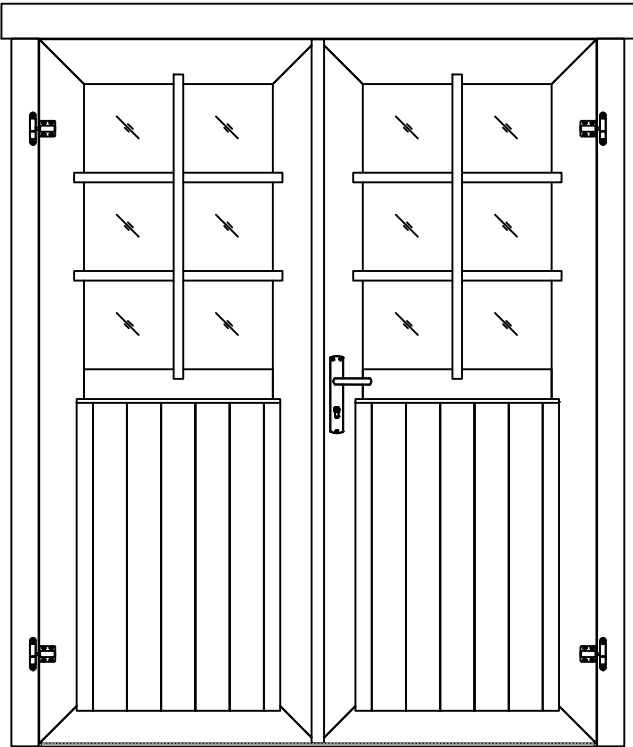

Art.Nr. 2841150

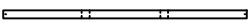
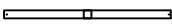

Pos	24.08.2017 Piece list - Stückliste - Liste des pièces - Elementi - Stuklijst - Joonis Art.Nr. 2841150	5/6	Q	P (mm)	L (mm)
001			2	28x57	1748
002			16	28x114	1748
003			16	28x114	526
004			16	28x114	526
011			1	28x57	5000
012			16	28x114	5000
013			34	28x114	3200
W1-1			1		
W2-1			1		
A-PR1	Roof beam - Dachbalken - Panne de toit - Perlina del tetto - Gordingen / dakbalk - Abipärliid 		7	44x140	3200
	Roof boards - Dachbretter - Voliges - Perlina per tetto - Dakhout - Katuselaud 		72	90x15	2700
	Roofing felt fillet - Dachpappenleiste - Baguette de fixation du feutre bitumeux - Asse per fissaggio guaina bituminosa - Afdeklijst asfaltpapier - Katusepapiilist 		4	15x45	2750
DPP-1	Roofing felt (strip) - Dachpappe (bahnen) - Feutre bitumeux (bande) - Cartone catramato - Asfaltpapier (baan) - Katusepapp 		6		3300
DRV-1	Roof edge reinforcement - Dachrandverstärkung - Corniere de renfort de bord de toit - Rinforzo x tetto - Dakrand versterking - Räästatugevdus 		2	15x45	3200
KFS-1	Storm protection - Sturmleiste - Latte anti-tempete - Protezione anti vento - Stormverankering / beveiligung - Tormikinnitus 		4	22x45	2050
	Gable moulding - Giebelleiste - Planche de rive - Finitura per frontale e retro del tetto - Gevellijst - Viilulaud 		4	15x120	2750
HS8	Screw for gable segment - Schrauben für deckblatt - Vis pour fixation losange de finition - Viti x frontali tetto - Schroef voor gevelpunt segment - Kruvi rombile 		4	3.5x35	
HS9	Screw for gable moulding - Schrauben für giebelleiste - Vis pour fixation planche de rive - Vite per fissare finiture davanti e dietro del tetto - Schroef voor gevellijst - Kruvi viilulauale 		40	3.5x50	
HS4	Screw for roof edge reinforcement - Schrauben für dachrandverstärkung - Vis pour fixation corniere renfort de bord de toit - Viti x rinforzo bordo tetto - Schroef voor dakrand versterking - Kruvi räästatugevdusele 		14	3x30	
HS18	Screw for roof beams - Schrauben für dachbalken - Vis pour fixation pannes de toit - Viti per perline del tetto - Schroef voor gordingen / dakbalken - Kruvi pärlinitele 		14	5x120	
HS18	Screw for gable - Schrauben für giebel - Vis pour fixation des pignons - Viti per timpano - Schroef voor gevelpunt - Kruvi viilude kinnitamiseks 		4	5x120	

Pos	19.12.2017	Piece list - Stückliste - Liste des pièces - Elementi - Stuklijst - Tükítabel 14 94x1850 TUK.2.056.SVP.MMX28 SGA+28	1/2	Q	P (mm)	L (mm)
Glass size - Glasgröße - Taille de la vitre - Misura del vetro - Glas afmeting - Klaasi mõõt: 502x750 mm				 <p>1418x1794 mm</p>		
						
1	Upper door jamb - Türrahmen oben - Cadre de porte supérieur - Telaio superiore della porta - Bovendorpel - Ukse ülemine leng			1	66x100	1438
2	Left door jamb - Türrahmen links - Cadre de porte gauche - Telaio montante sinistro della porta - Linkerstijl deurframe - Ukse vasak leng			1	66x80	1850
3	Right door jamb - Türrahmen rechts - Cadre de porte droit - Telaio montante destro della porta - Rechterstijl deurframe - Ukse parem leng			1	66x80	1850
4	Doorstep - Swelle - Barre de seuil - Soglia della porta - Deurdorpel - Lävepakk			1	20x21	1418
5	Connection strip - Deckleiste - Baguette de battement - Profilo verticale della porta - Stulplijst - Kokkuvalltsiliist			1	13x32	1812
6	Georgian bars - Sprossen - Croisillons - La griglia georgiana - Raamverdeling - Petteliistud			2	15x25	784
7	Georgian bars - Sprossen - Croisillons - La griglia georgiana - Raamverdeling - Petteliistud			4	15x25	536

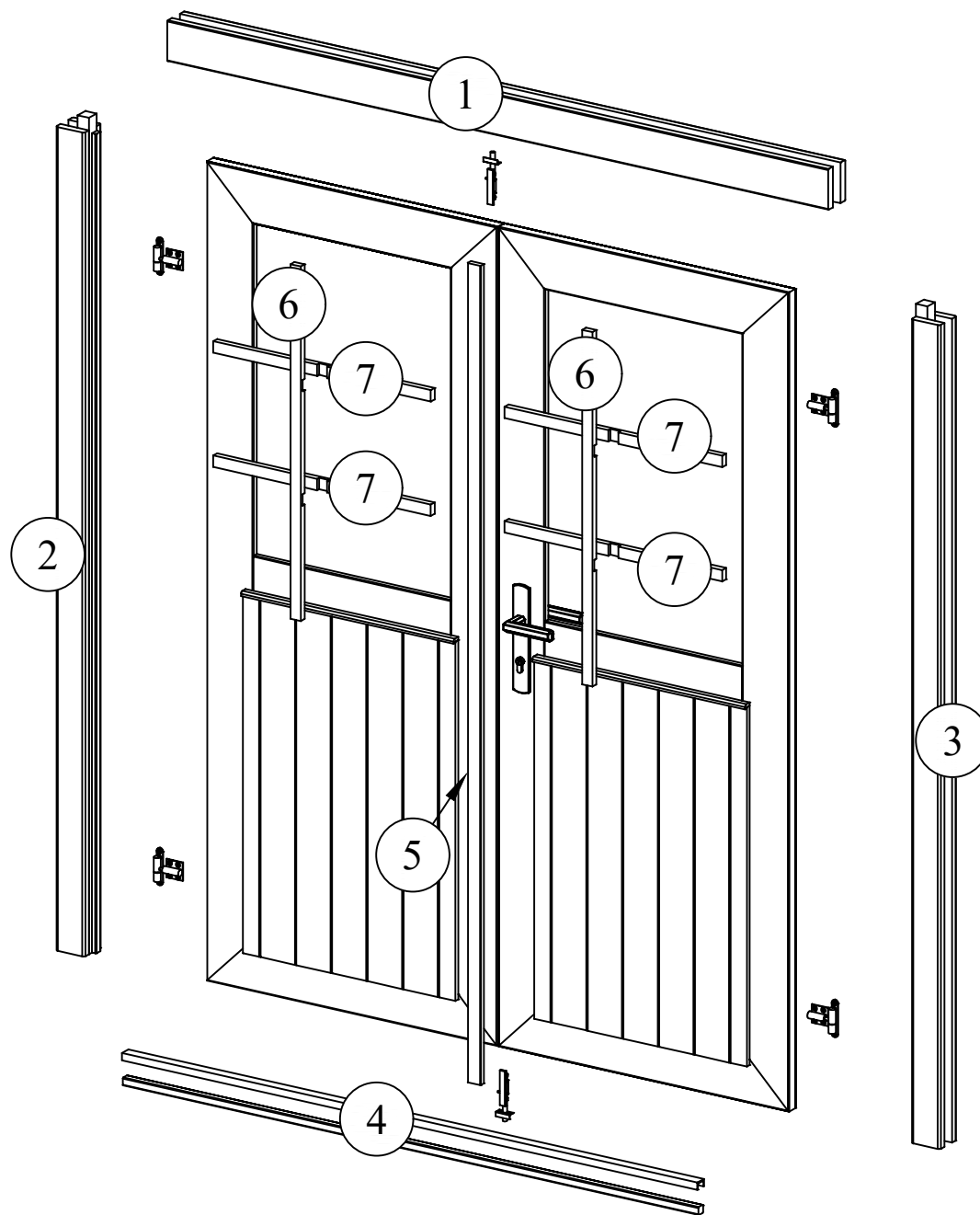

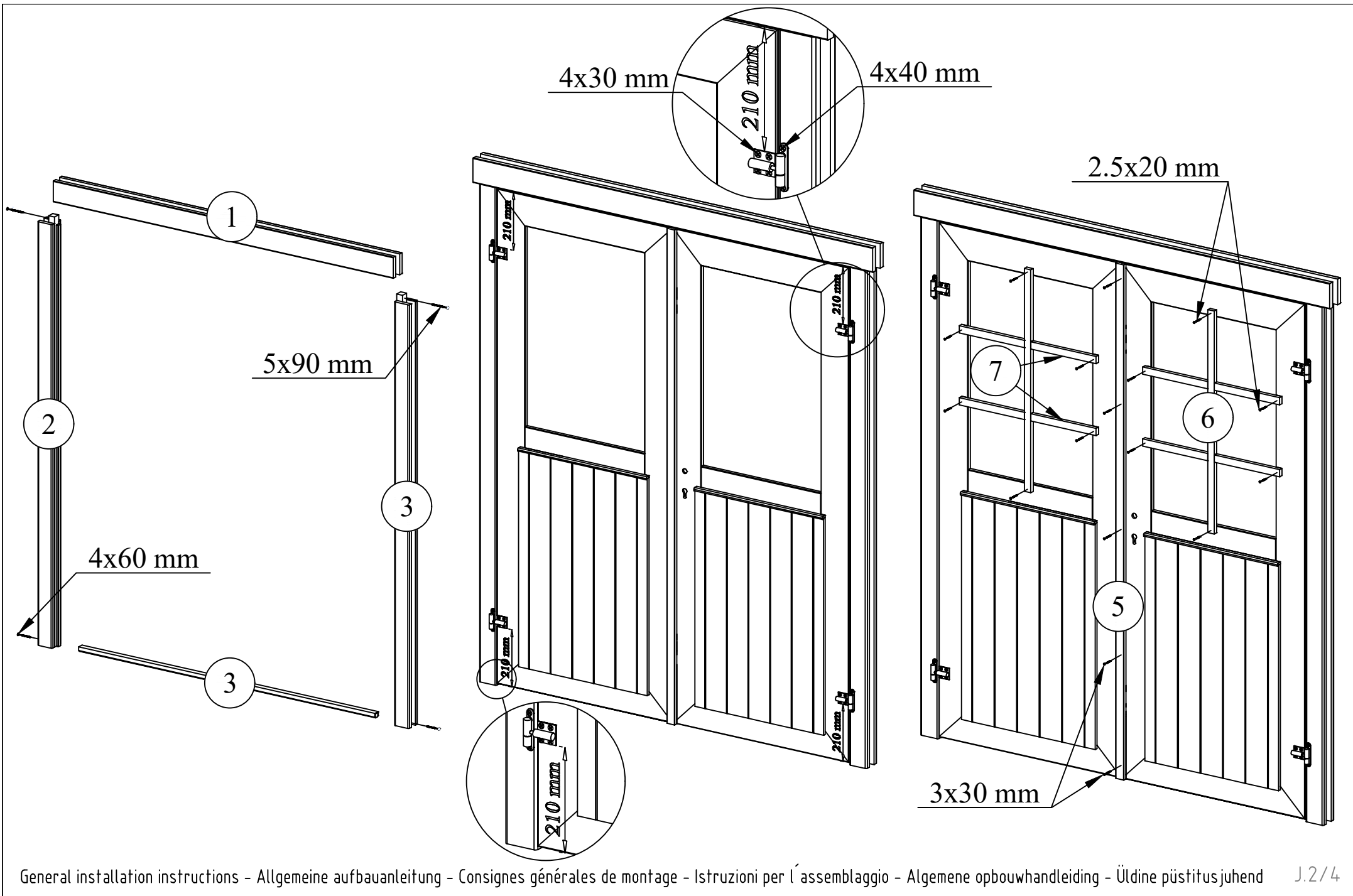

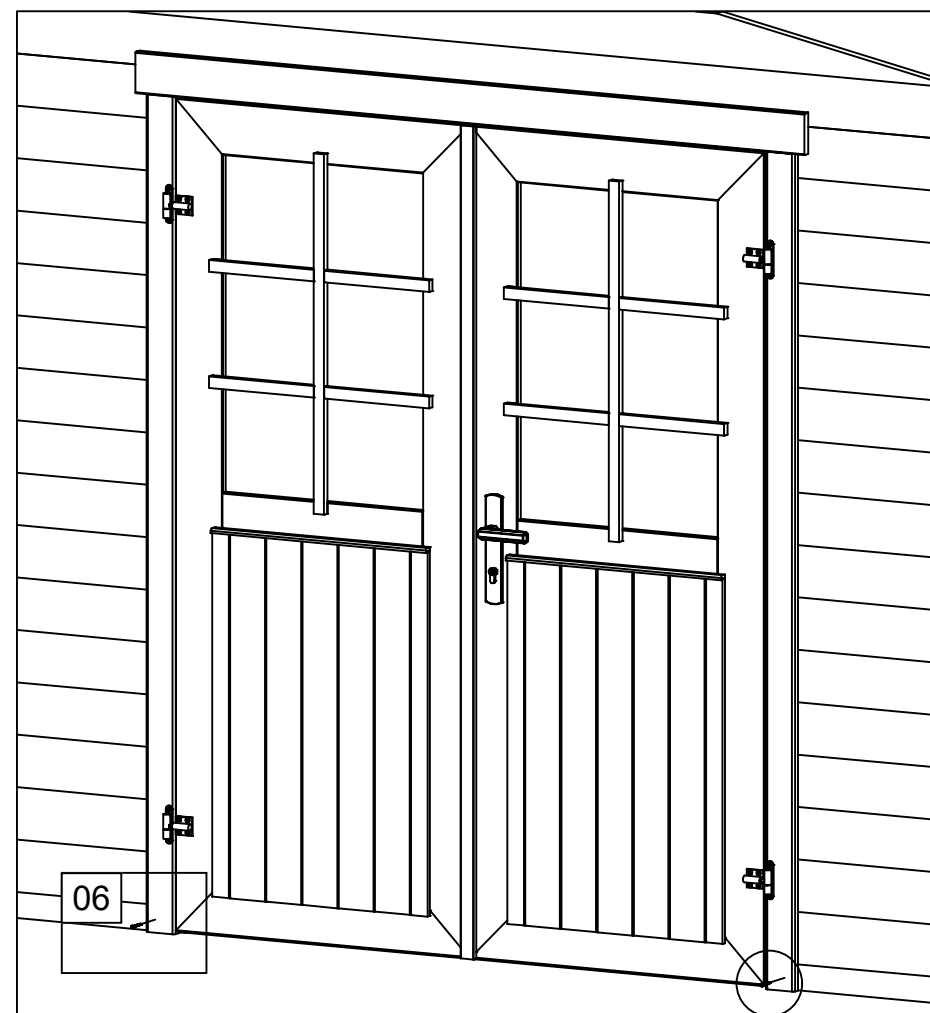
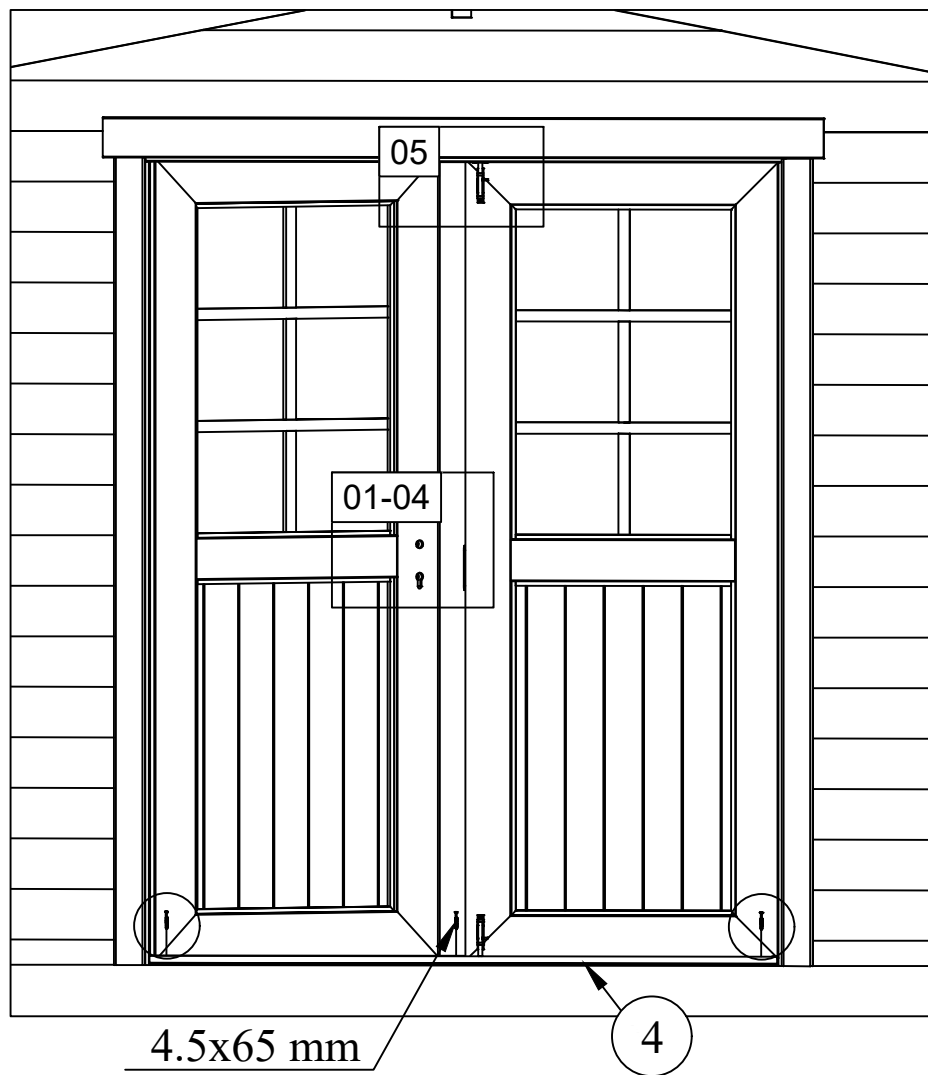

01



04

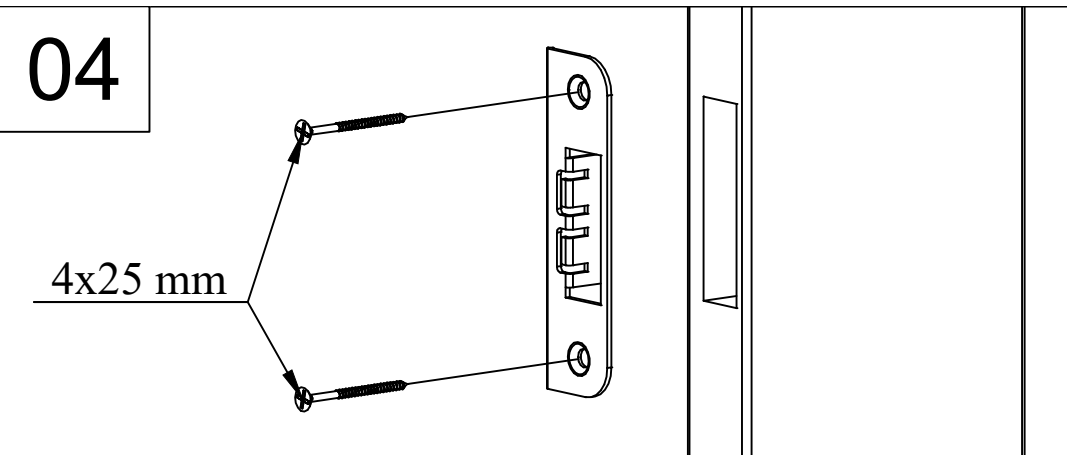

02

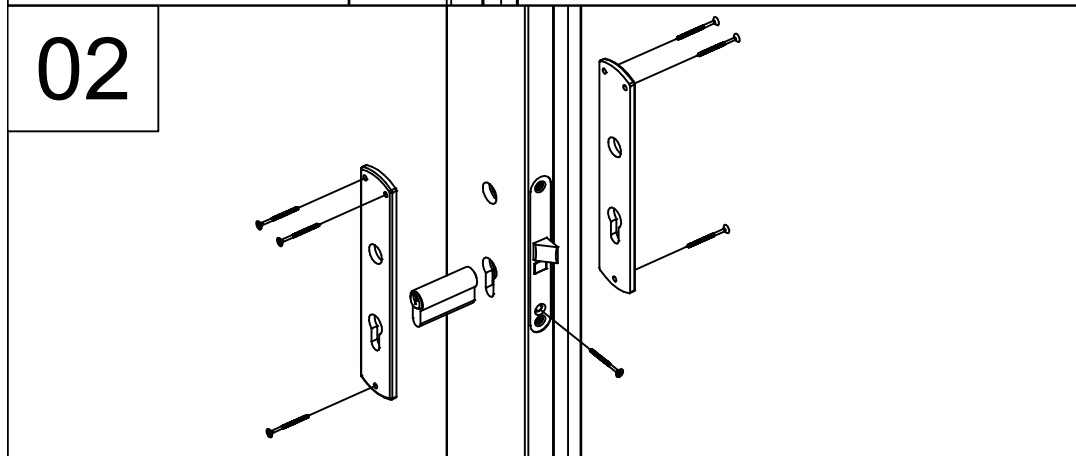

05

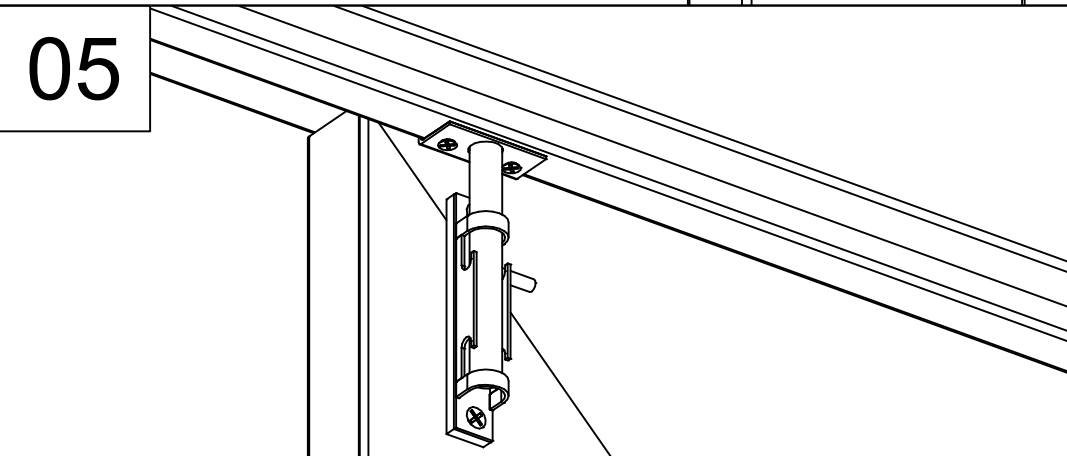



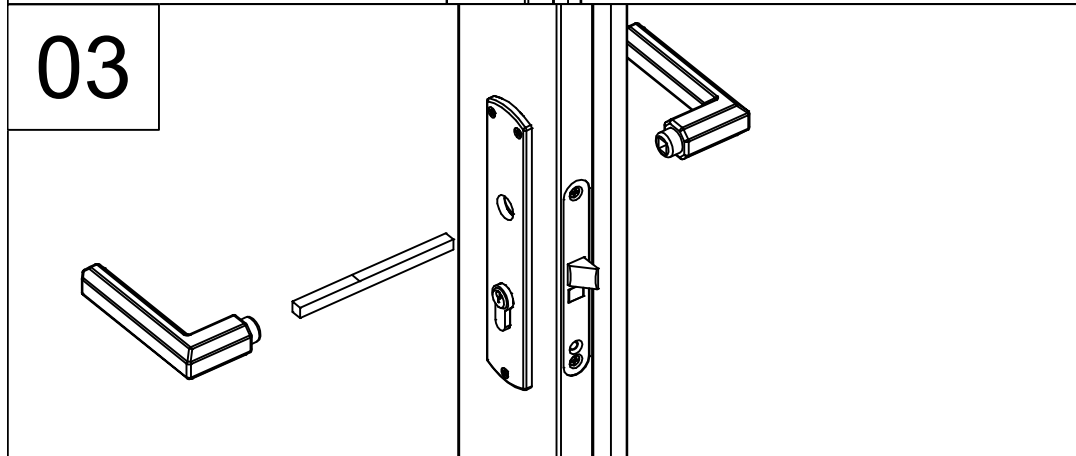



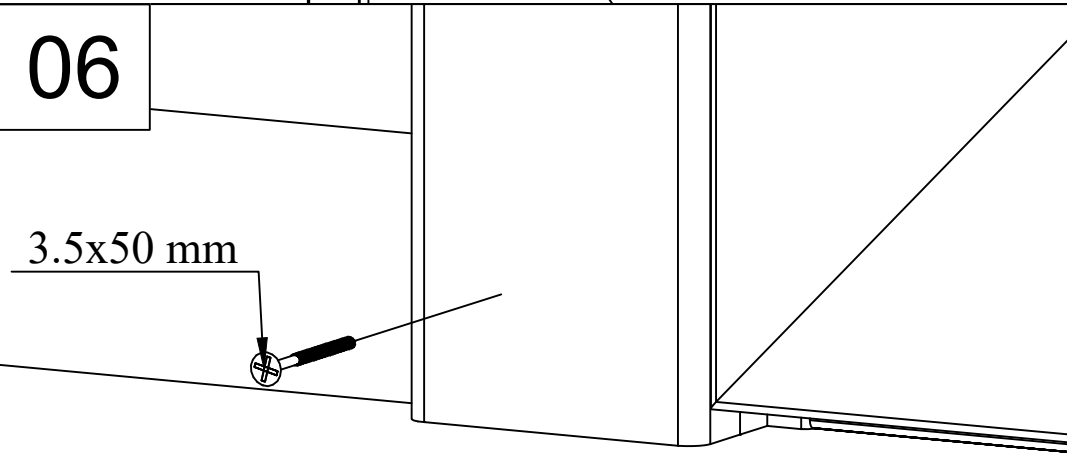

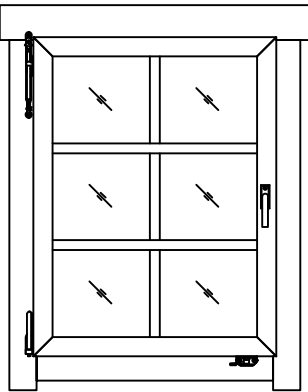
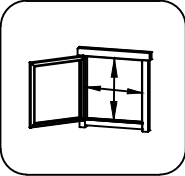



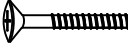
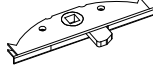

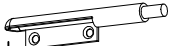



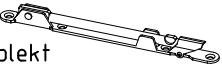
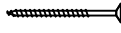
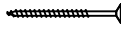
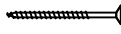

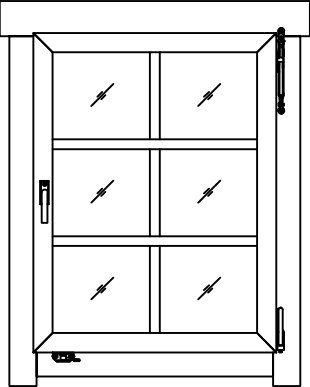
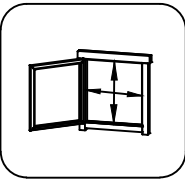

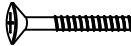
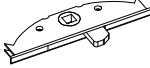

03



06

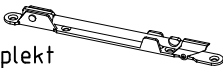

Pos	19.12.2017	Piece list - Stückliste - Liste des pièces - Elementi - Stuklijst - Tükitalabel 685x882 AK.1.106.SSV.d SGA	1/1	Q	P (mm)	L (mm)
		Glass size - Glasgröße - Taille de la vitre - Misura del vetro - Glas afmeting - Klaasi mõõt: 542x738 mm				
					585x782 mm	
1		Georgian bars - Sprossen - Croisillons - La griglia georgiana - Raamverdeling - Petteliistud		1	15x25	757
2		Georgian bars - Sprossen - Croisillons - La griglia georgiana - Raamverdeling - Petteliistud		2	15x25	576
FS1		Window handle fittings - Fenstergriff - Poignée de fenetre - Maniglia c/ferramenta - Raamhendel -/grendel -/klink - Aknalink		1		
FSP		Bolt for window handle fittings - Bolzen für fenstergriff beschlag - Vis pour fixation poignée de fenetre - Bullone x apertura manuale finestra - Schroef voor raamhendel - Akna käepideme polt		2		
FSL		Window closer - Fenstergriff - Système de fermeture pour fenêtre - Serratura della finestra - Raamslotje - Akna sulguri südamik		1		
FSA		Window closer striker - Gegenstück für Fenstergriff - Entrebâilleur de fenetre - Attacco aggancio per serratura della finestra - Raam sluitplaatje - Akna luku vastus		1		
NA1		Tilt & turn window set - Dreh-Kipp-Beschlag für Fenster - Ensemble de fenêtres oscillo-battantes - Insieme per il fermo dell'oscillazione del battente della finestra - Draaikiep raamsetje - Kald-pöördsuluse komplekt		1		
NA2		Tilt & turn window set - Dreh-Kipp-Beschlag für Fenster - Ensemble de fenêtres oscillo-battantes - Insieme per il fermo dell'oscillazione del battente della finestra - Draaikiep raamsetje - Kald-pöördsuluse komplekt		1		
NA3		Tilt & turn window set - Dreh-Kipp-Beschlag für Fenster - Ensemble de fenêtres oscillo-battantes - Insieme per il fermo dell'oscillazione del battente della finestra - Draaikiep raamsetje - Kald-pöördsuluse komplekt		1		
NA4		Tilt & turn window set - Dreh-Kipp-Beschlag für Fenster - Ensemble de fenêtres oscillo-battantes - Insieme per il fermo dell'oscillazione del battente della finestra - Draaikiep raamsetje - Kald-pöördsuluse komplekt		1		
NA5		Tilt & turn window set - Dreh-Kipp-Beschlag für Fenster - Ensemble de fenêtres oscillo-battantes - Insieme per il fermo dell'oscillazione del battente della finestra - Draaikiep raamsetje - Kald-pöördsuluse komplekt		1		
NA6		Tilt & turn window set - Dreh-Kipp-Beschlag für Fenster - Ensemble de fenêtres oscillo-battantes - Insieme per il fermo dell'oscillazione del battente della finestra - Draaikiep raamsetje - Kald-pöördsuluse komplekt		1		
HS1		Screw for georgian bars - Schraube für sprossen - Vis pour croisillons - Viti per unire la griglia georgiana della finestra - Schroeven voor raamverdeling - Kruvi akna petteliistule		6	2.5x20	
HS31		Screw for window closer striker - Schraube für Gegenstück / Fenstergriff - Vis pour entrebâilleur de fenetre - viti per attacco della serratura della finestra - Schroef voor raam sluitplaatje - Kruvi akna luku vastusele		2	3.5x15	
HS10		Screw for tilt & turn window set - Schraube für Dreh-Kipp-Beschlag - Vis pour système oscillo-battant - Viti per attacco dell'insieme del fermo per oscillazione del battente della finestra - Schroeven voor draaikiepssetje - Kruvi kald-pöördsuluse komplektille		14	4x25	

Pos	19.12.2017	Piece list - Stückliste - Liste des pièces - Elementi - Stuklijst - Tükitalabel 685x882 AK.1.106.SSP.d SGA	1/1	Q	P (mm)	L (mm)
		Glass size - Glasgröße - Taille de la vitre - Misura del vetro - Glas afmeting - Klaasi mõõt: 542x738 mm				
					585x782 mm	
1		Georgian bars - Sprossen - Croisillons - La griglia georgiana - Raamverdeling - Petteliistud		1	15x25	757
2		Georgian bars - Sprossen - Croisillons - La griglia georgiana - Raamverdeling - Petteliistud		2	15x25	576
FS1		Window handle fittings - Fenstergriff - Poignee de fenetre - Maniglia c/ferramenta - Raamhendel -/grendel -/klink - Aknalink		1		
FSP		Bolt for window handle fittings - Bolzen für fenstergriff beschlag - Vis pour fixation poignee de fenetre - Bullone x apertura manuale finestra - Schroef voor raamhendel - Akna käepideme pölt		2		
FSL		Window closer - Fenstergriff - Système de fermeture pour fenêtre - Serratura della finestra - Raamslotje - Akna sulguri südamik		1		
FSA		Window closer striker - Gegenstück für Fenstergriff - Entrebâilleur de fenetre - Attacco aggancio per serratura della finestra - Raam sluitplaatje - Akna luku vastus		1		
NA1		Tilt & turn window set - Dreh-Kipp-Beschlag für Fenster - Ensemble de fenêtres oscillo-battantes - Insieme per il fermo dell'oscillazione del battente della finestra - Draaikiep raamsetje - Kald-pöördsuluse komplekt		1		
NA2		Tilt & turn window set - Dreh-Kipp-Beschlag für Fenster - Ensemble de fenêtres oscillo-battantes - Insieme per il fermo dell'oscillazione del battente della finestra - Draaikiep raamsetje - Kald-pöördsuluse komplekt		1		
NA3		Tilt & turn window set - Dreh-Kipp-Beschlag für Fenster - Ensemble de fenêtres oscillo-battantes - Insieme per il fermo dell'oscillazione del battente della finestra - Draaikiep raamsetje - Kald-pöördsuluse komplekt		1		
NA4		Tilt & turn window set - Dreh-Kipp-Beschlag für Fenster - Ensemble de fenêtres oscillo-battantes - Insieme per il fermo dell'oscillazione del battente della finestra - Draaikiep raamsetje - Kald-pöördsuluse komplekt		1		
NA5		Tilt & turn window set - Dreh-Kipp-Beschlag für Fenster - Ensemble de fenêtres oscillo-battantes - Insieme per il fermo dell'oscillazione del battente della finestra - Draaikiep raamsetje - Kald-pöördsuluse komplekt		1		
NA6		Tilt & turn window set - Dreh-Kipp-Beschlag für Fenster - Ensemble de fenêtres oscillo-battantes - Insieme per il fermo dell'oscillazione del battente della finestra - Draaikiep raamsetje - Kald-pöördsuluse komplekt		1		
HS1		Screw for georgian bars - Schraube für sprossen - Vis pour croisillons - Viti per unire la griglia georgiana della finestra - Schroeven voor raamverdeling - Kruvi akna petteliistule		6	2.5x20	
HS31		Screw for window closer striker - Schraube für Gegenstück / Fenstergriff - Vis pour entrebâilleur de fenetre - viti per attacco della serratura della finestra - Schroef voor raam sluitplaatje - Kruvi akna luku vastusele		2	3.5x15	
HS10		Screw for tilt & turn window set - Schraube für Dreh-Kipp-Beschlag - Vis pour système oscillo-battant - Viti per attacco dell'insieme del fermo per oscillazione del battente della finestra - Schroeven voor draaikiepssetje - Kruvi kald-pöördsuluse komplektille		14	4x25	

