

Assembly Instructions

Please check that you have all the parts listed before you start assembling, if you do find that something is missing, do not continue assembly, please contact us immediately.

NOTE: Please do not completely tighten all the hardware until the entire assembly is complete!

Bauanleitung

Bitte überprüfen Sie, ob alle Teile mitgeliefert sind, bevor Sie mit der Montage beginnen. Wenn Sie festlegen, dass etwas fehlt, setzen Sie die Montage nicht fort. Bitte kontaktieren Sie uns sofort.



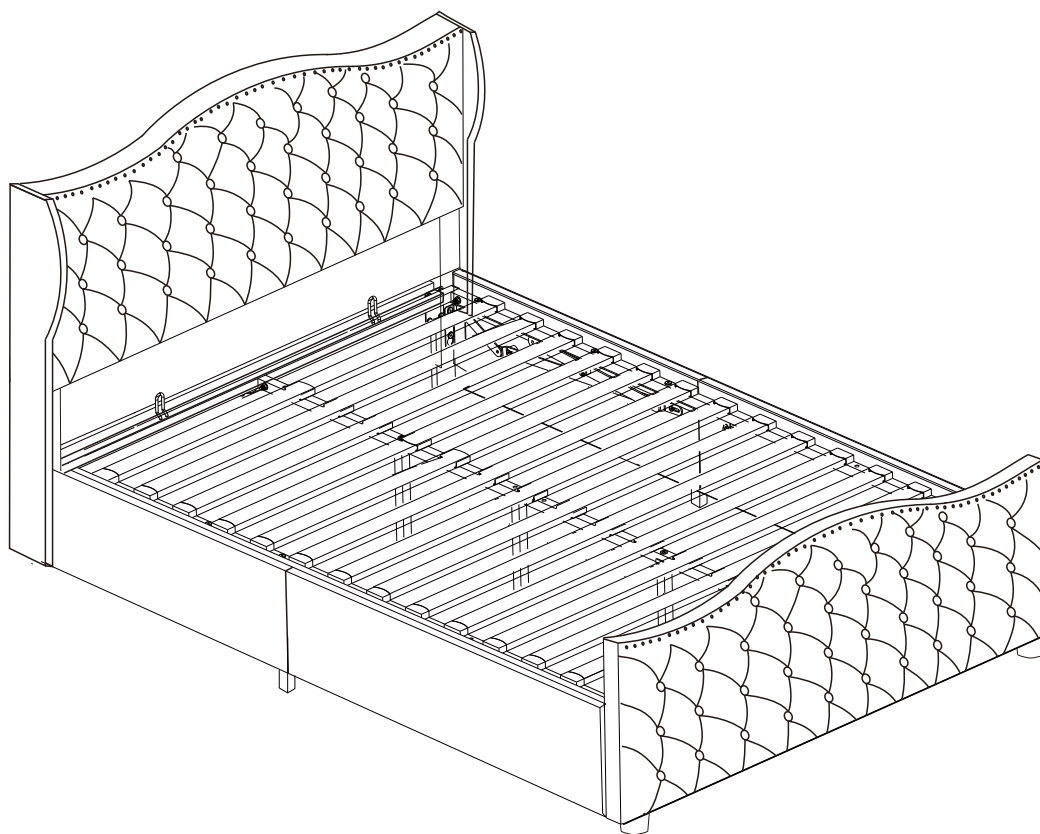



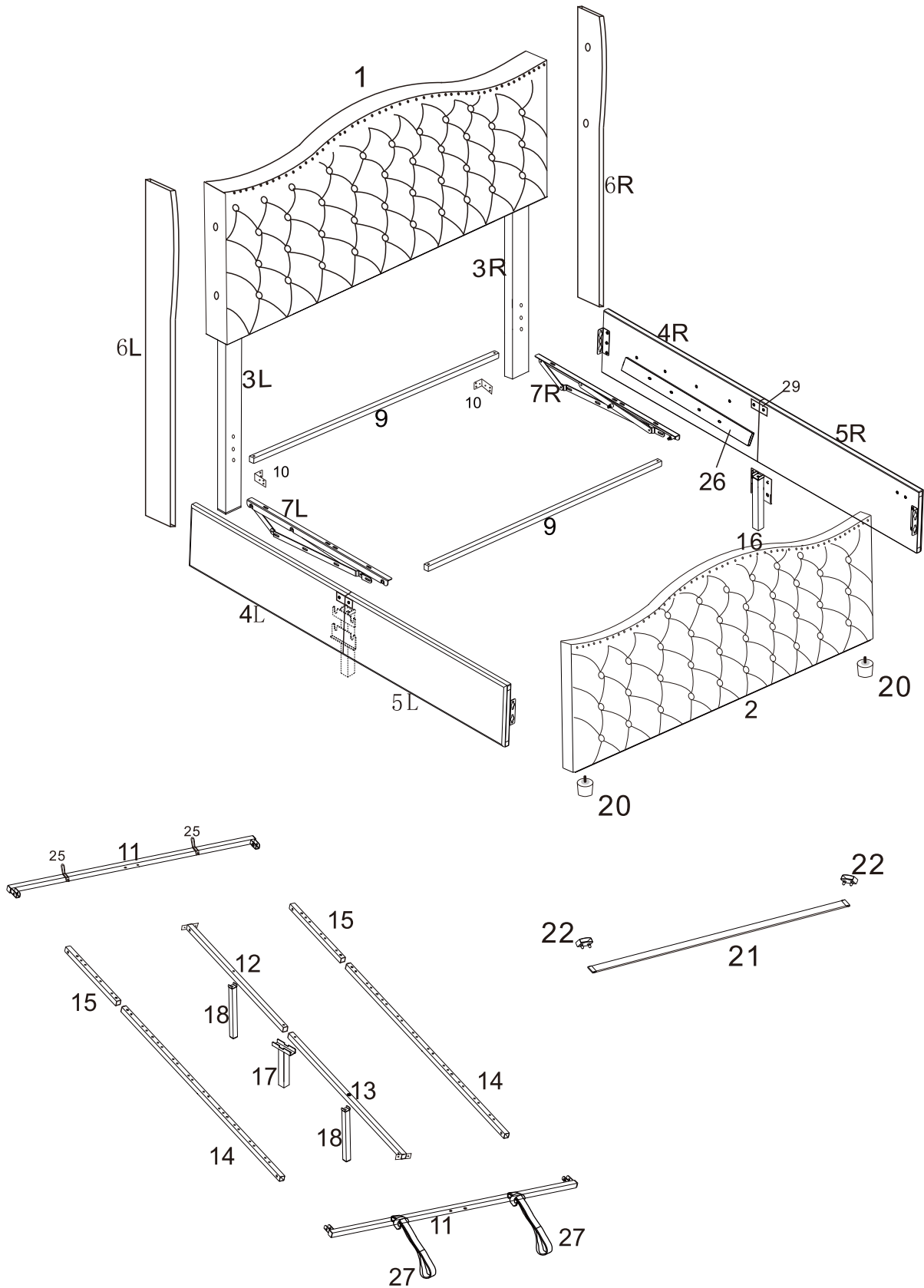



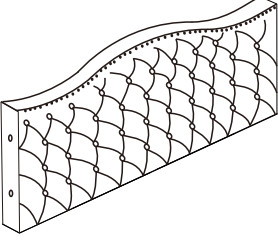
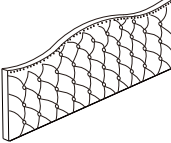

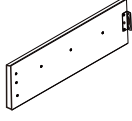
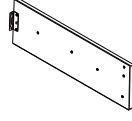
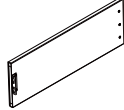
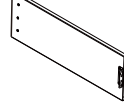

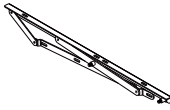
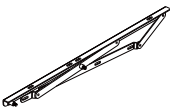
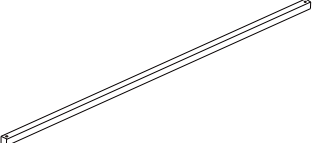

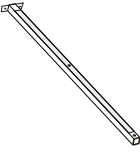
Achtung: Bitte ziehen Sie nicht alle Schrauben fest, bevor die Montage abgeschlossen ist!

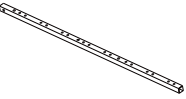
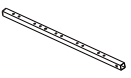
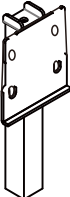
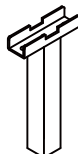
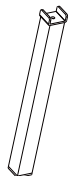
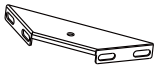

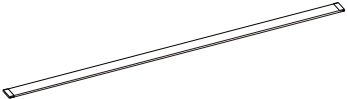

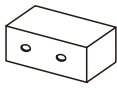
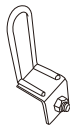









Stückliste





Part List-Stückliste

1  x1	2  x1	3L  x1	3R  x1		
4L  x1	4R  x1	5L  x1	5R  x1	6L  x1	6R  x1
7L  x1	7R  x1	9  x2			
10  x2	11  x2	12  x1	13  x1		
14  x2	15  x2	16  x2	17  x1	18  x2	
19  x2	20  x2	21  x12	22  x24	23	
24  x1	25  x2	26  x2	27  x2	28  x1	29  x2

Hardware List- Hardware-Liste

 5/16*45MM A*28+3 PCS	 5/16*30MM B* 16 +2PCS	 5/16*20MM C* 4 PCS	 1/4x15mm D* 20+2PCS
 1/4x35mm E*8+1PCS	 5/16 F*18+2PCS	 Ø 19*5/16 G* 62+7PCS	 Ø 16*1/4 H* 28+2PCS
 M4x15mm I* 12 PC	 5/16 J* 1 PC	 1/4 K* 1 PC	 1/4 L* 1 PC
 5/16 M* 1 PC	N*	O*	

STEP 1

 5/16*45mm A* 4 PCS	 Ø 19*5/16 G* 4 PCS	 J*1PC
---	---	---

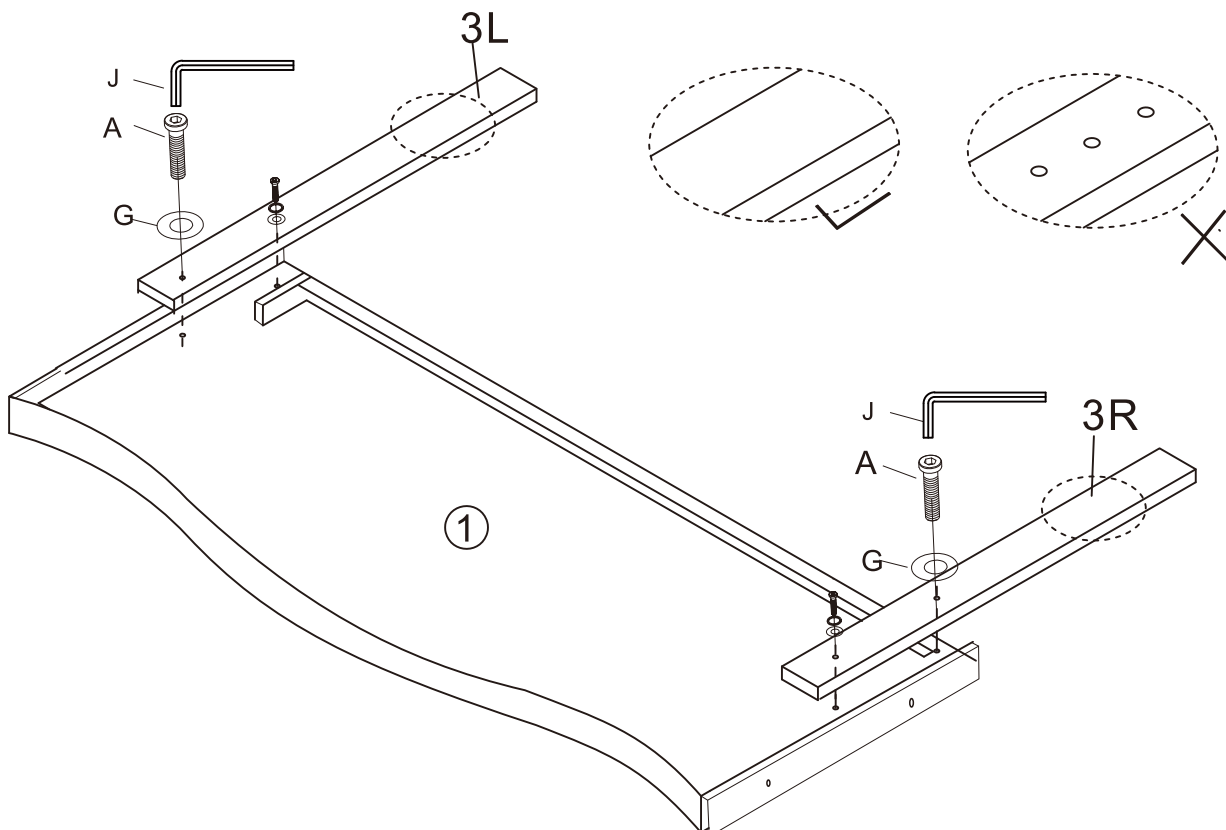



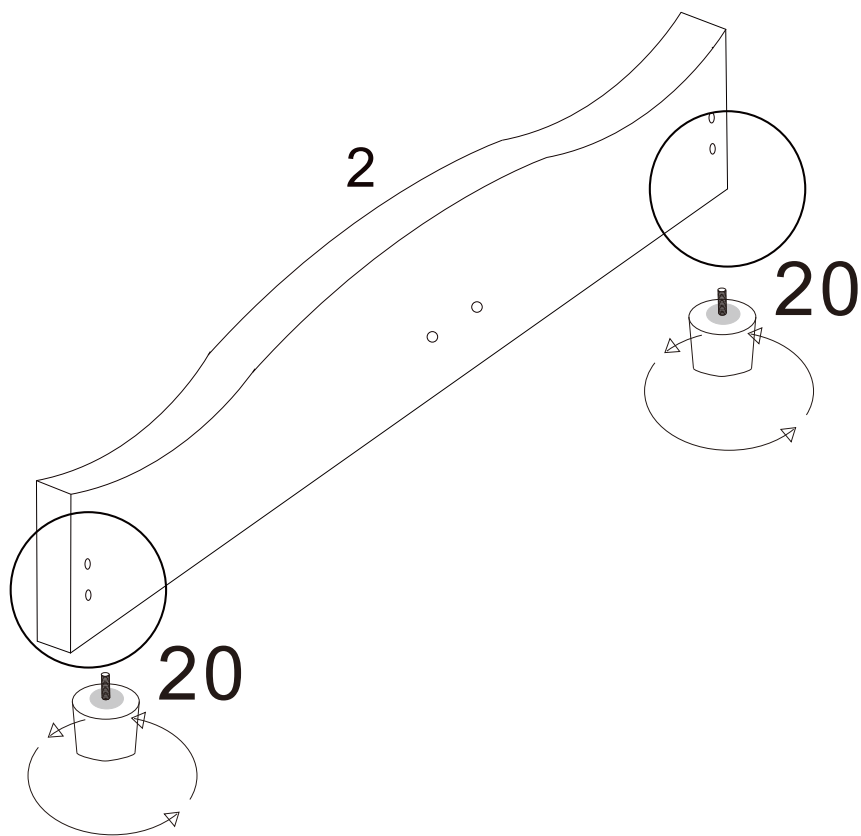

Lassen Sie bitte die Seite mit 3 Löcher des #E nach unten.

STEP 2 Bitte lösen Sie zuerst die am Fußbrett vorinstallierten Schrauben, müssen diese aber nicht komplett herausdrehen.

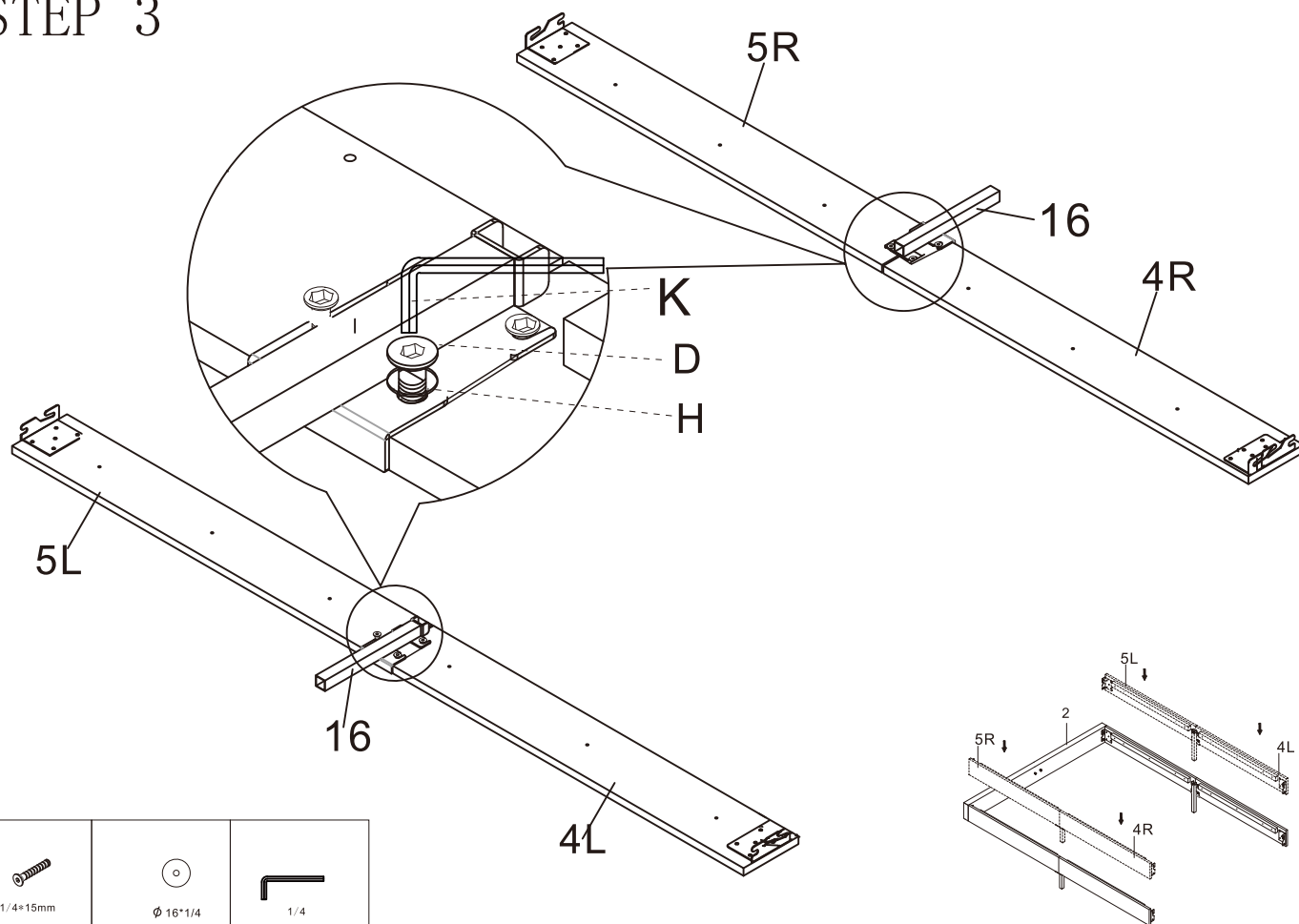







STEP 3

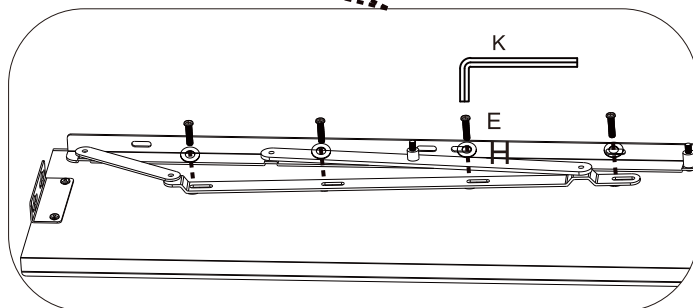
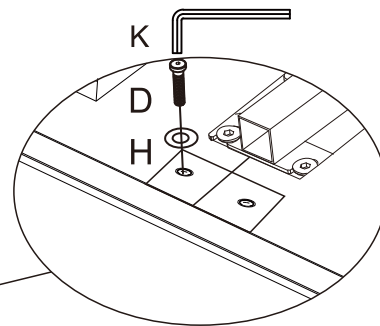
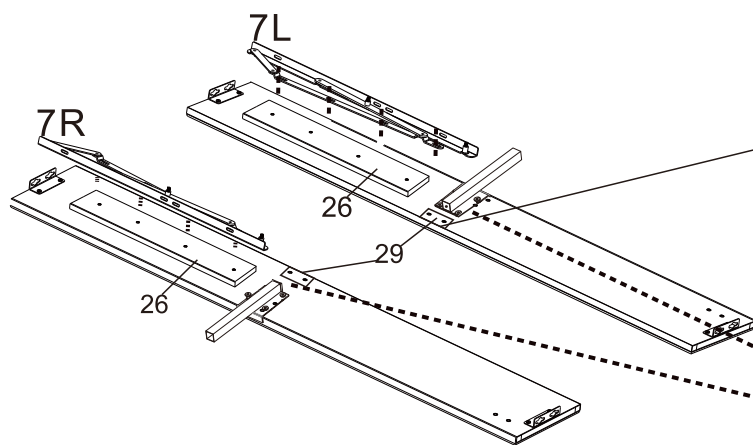

 1/4*15mm D*8PCS	 Ø 16*1/4 H*8PCS	 1/4 K*1PC
---	---	---

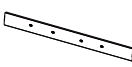

STEP 4



 1/4*15mm D*4PCS	 1/4 K*1PC	 29 2PCS	 26 2PCS
 1/4*35mm E*8PCS	 Ø 16*1/4 H*12PCS		

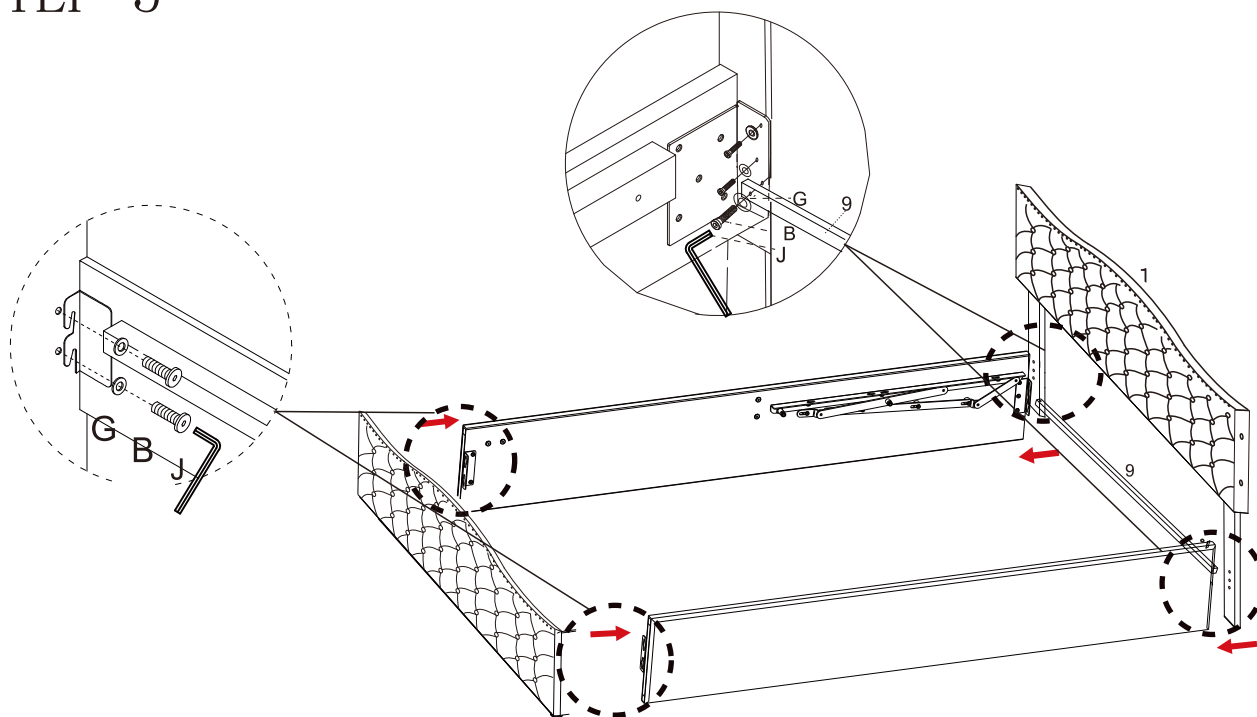





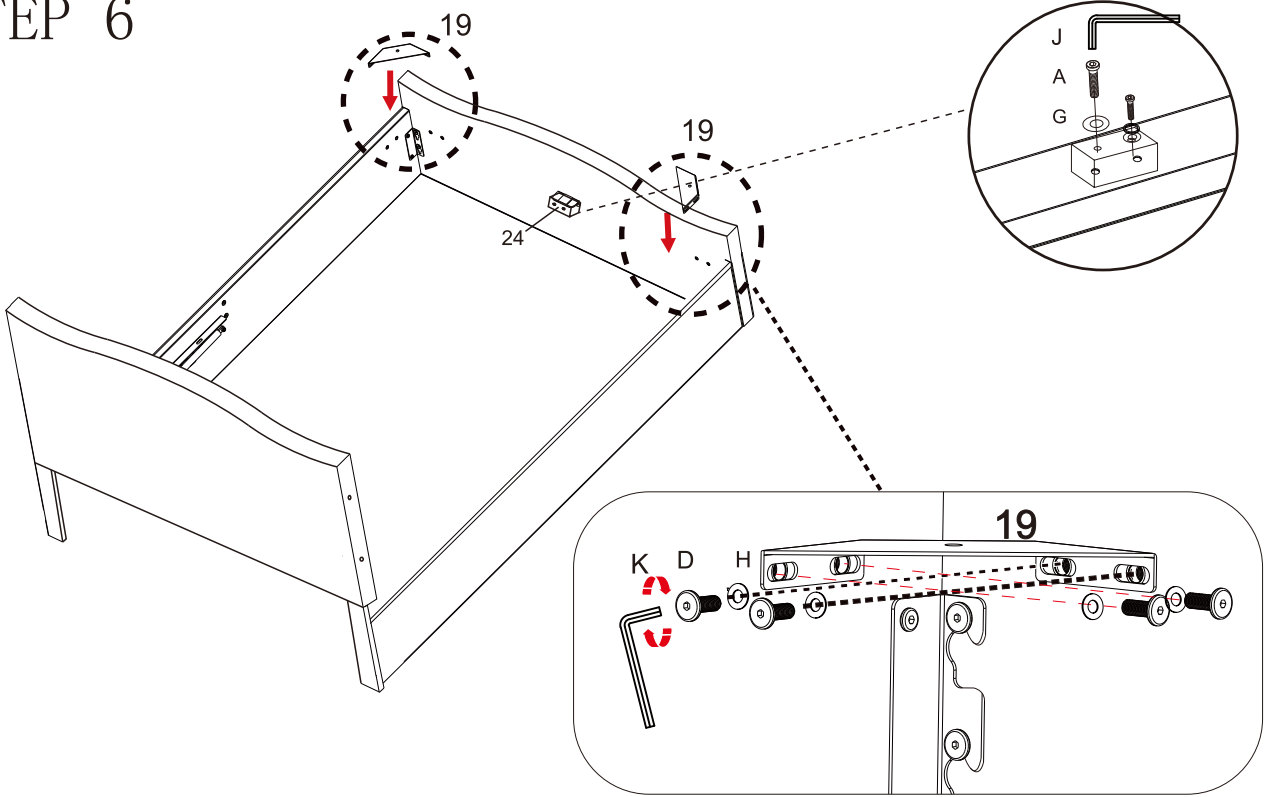

STEP 5



 5/16*30mm B*10PCS	 Ø 19*5/16 G*10 PCS	 J*1PC
---	--	--



STEP 6



 5/16 J*1PC	 5/16*45mm A* 2 PCS	 Ø 19*5/16 G*2 PCS	19 X2 	24 x 1 	 Ø 16*1/4 H*8 PCS	 1/4*15mm D*8PCS	 1/4 K*1PC
--	---	---	---	--	--	--	--

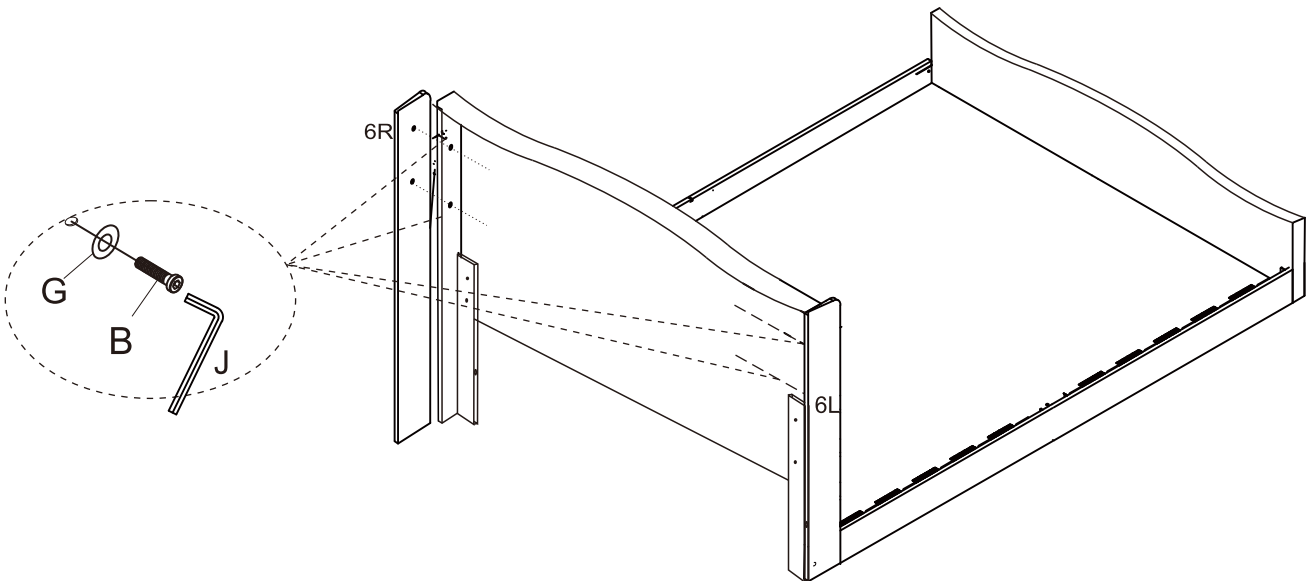





STEP 7

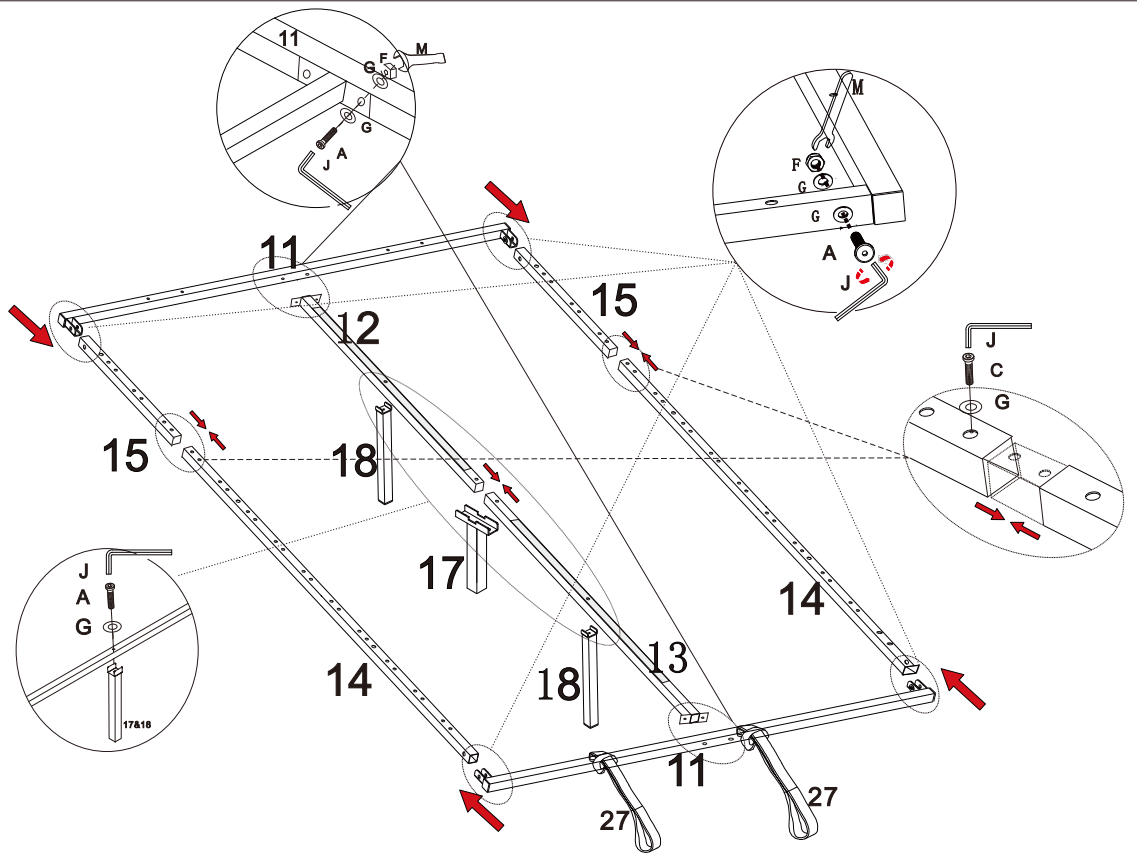

 5/16 J*1PC	 5/16*30mm B* 4 PCS	 Ø 19*5/16 G*4 PCS
---	--	---

STEP 8





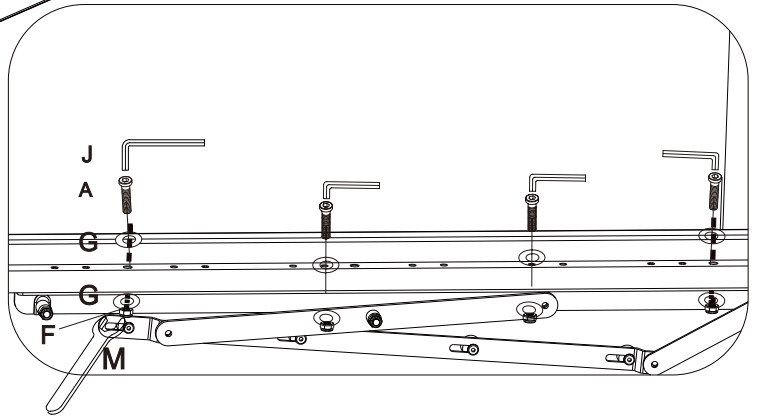
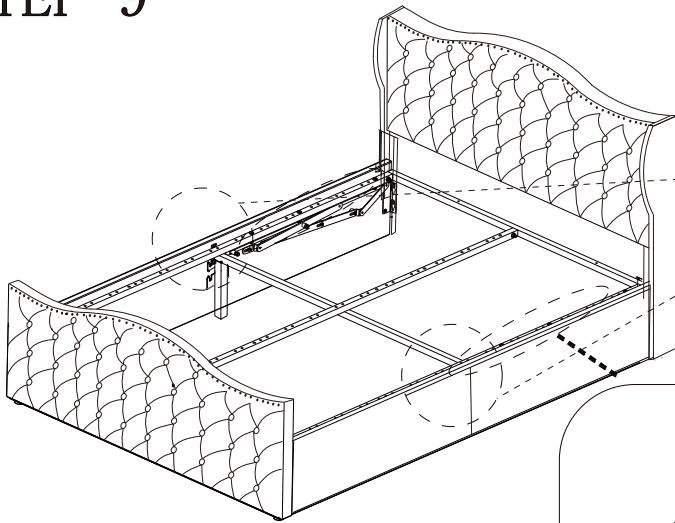

 5/16 J*1PC	 5/16*45mm A*12PCS	 Ø 19*5/16 G*24PCS	 F x 8 5/16	 M x 1	 5/16*20mm C* 4 PCS
---	--	--	---	---	--

STEP 9



 5/16*30mm B*2 PCS

 5/16 J*1PC	 5/16*45mm A* 8 PCS	 Ø 19*5/16 G*18PCS	 F x 8 5/16	 M x 1
---	--	---	--	--

STEP 10

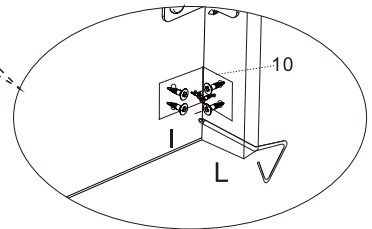
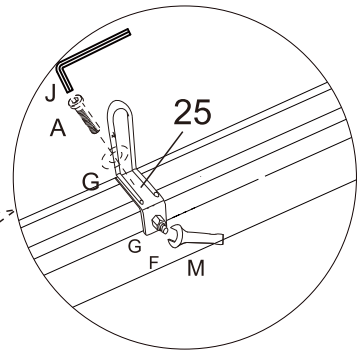
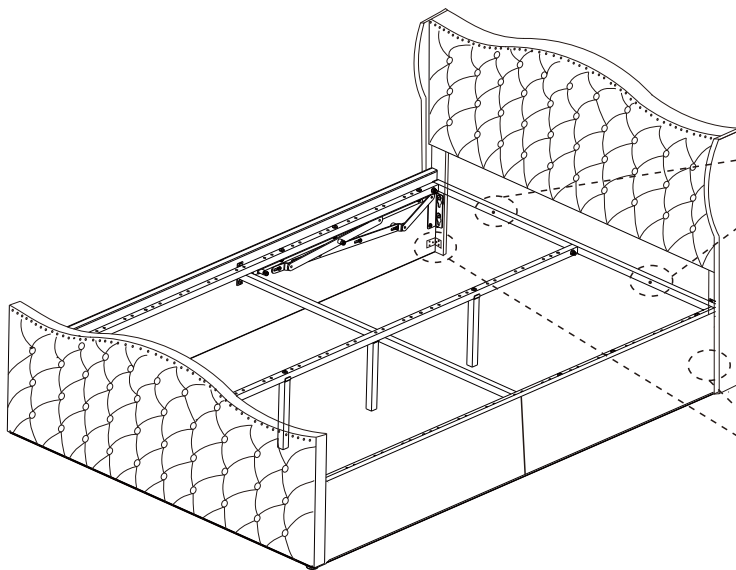

10 x2

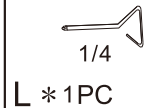
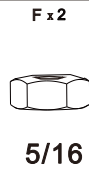
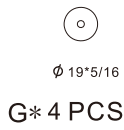
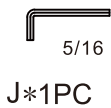

STEP 11

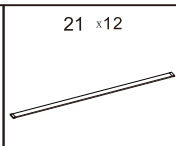
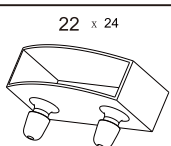
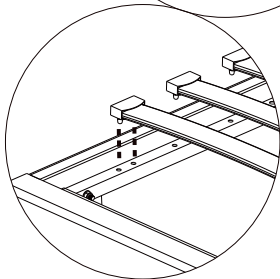
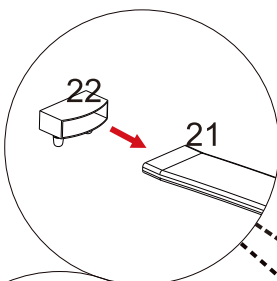
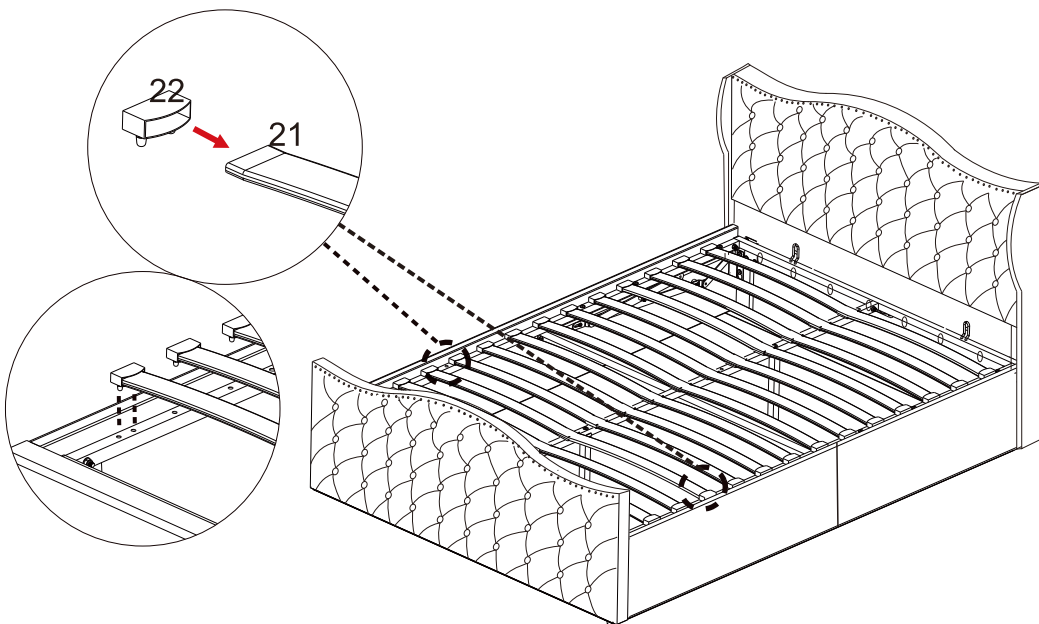

STEP 12

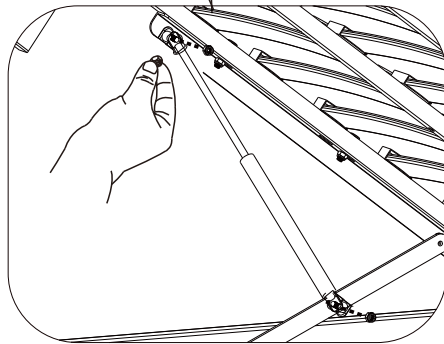
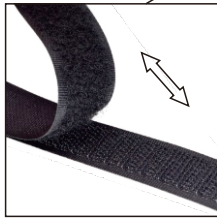
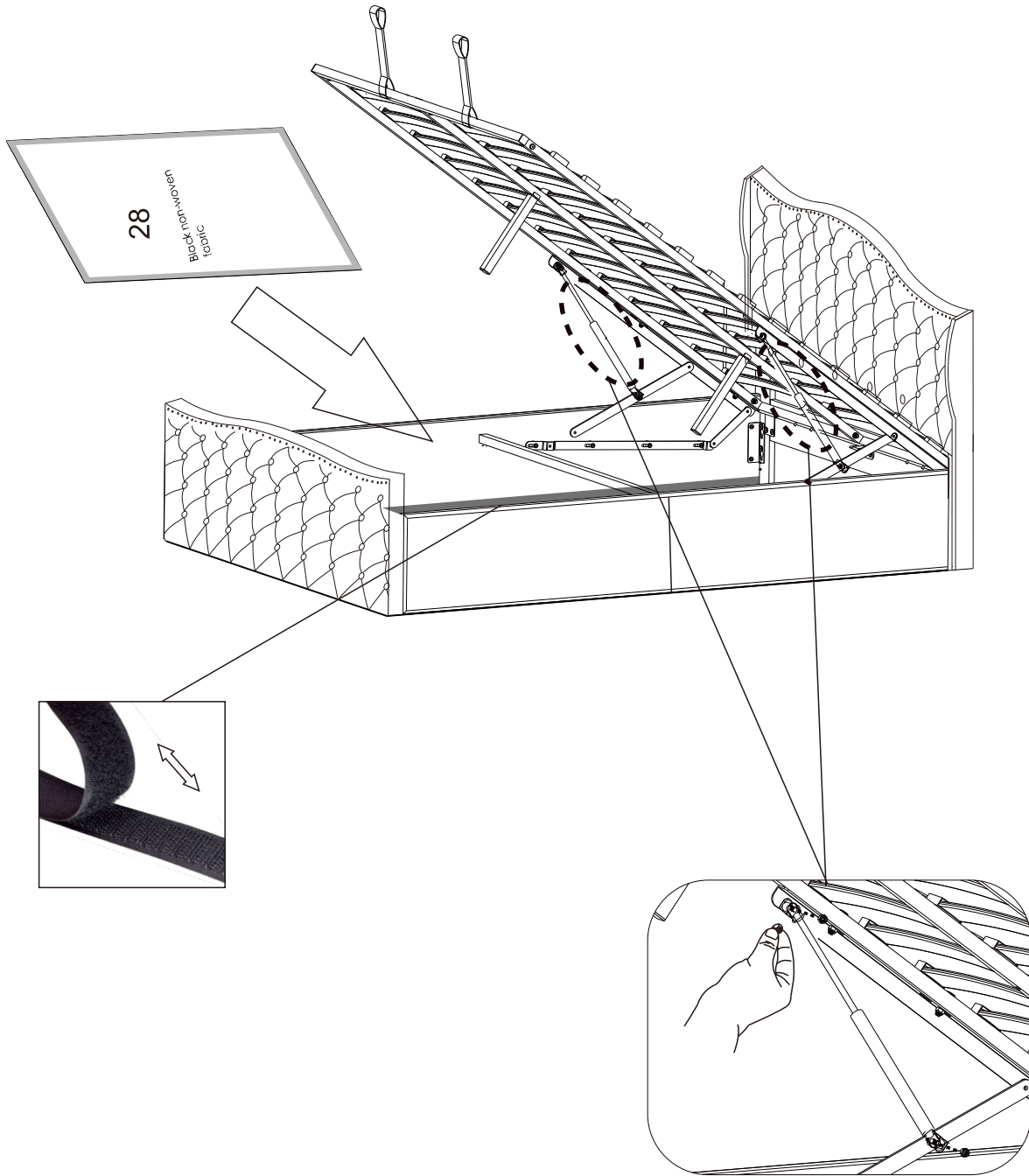

28 1pc