

STEFAN180A

50-028-H1

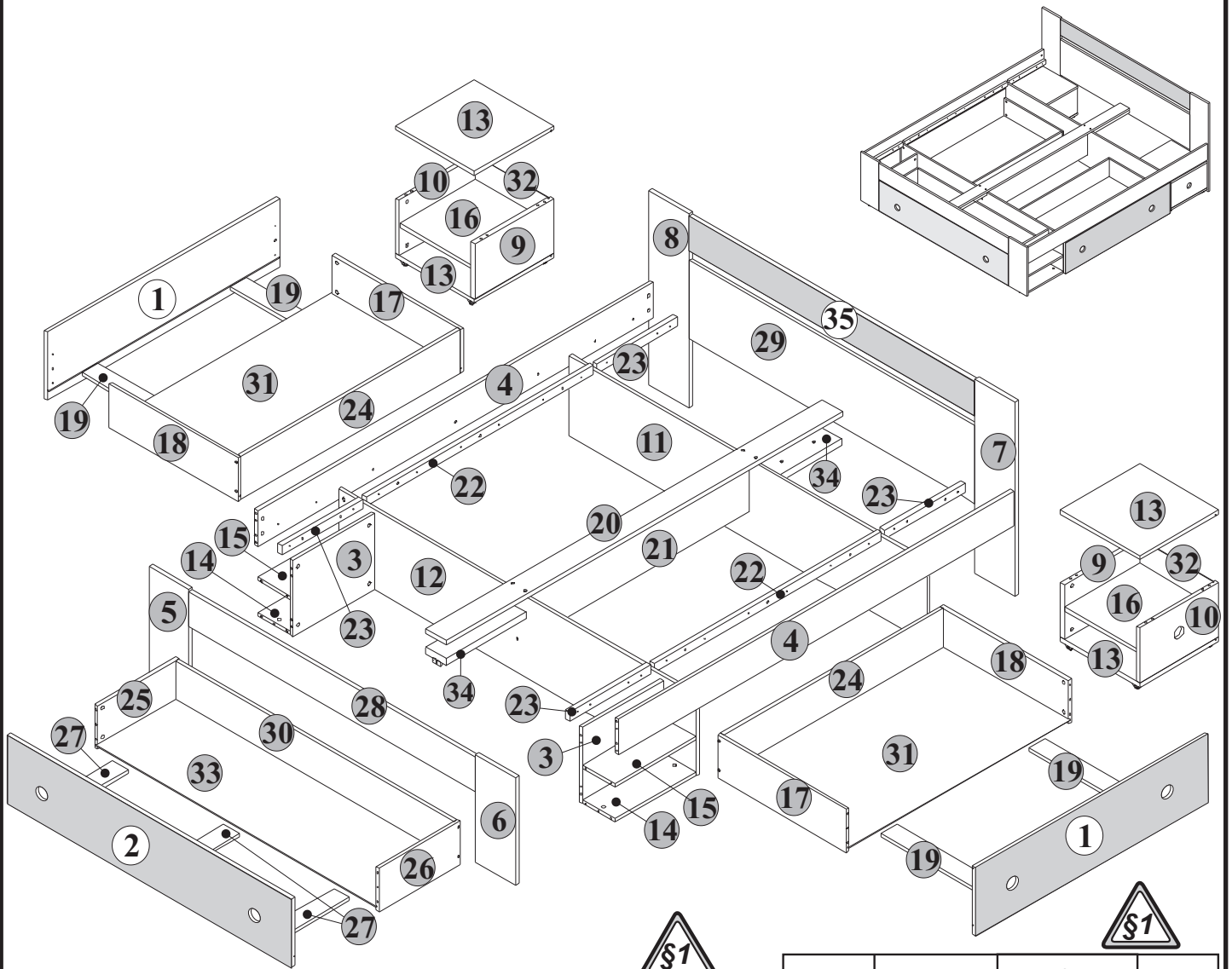

A	B	C	D
1	D13-003	1170x298	3/4
2	D13-005	1438x298	2/4
3	D13-157	335x410	3/4
4	D13-159	2000x155	1/4
5	D13-160	470x203	2/4
6	D13-161	470x203	2/4
7	D13-163	850x203	2/4
8	D13-164	850x203	2/4
9	D13-165	240x399	4/4
10	D13-166	240x399	4/4
11	D13-167A	1805x352	2/4
12	D13-168A	1805x352	2/4
13	D13-209	400x400	4/4
14	D13-303	410x163	3/4
15	D13-304	410x163	2/4; 3/4
16	D13-305	363x381	4/4
17	D13-521	650x190	3/4

A	B	C	D
18	D13-522	650x190	3/4
19	D13-524	634x80	3/4
20	D13-534	2000x104	1/4
21	D13-561	1150x273	3/4
22	D13-537	1148x40	1/4
23	D13-538	408x40	1/4
24	D13-541	1110x190	3/4
25	D13-542	411x190	3/4
26	D13-543	411x190	3/4
27	D13-545	395x80	3/4
28	D13-546	1445x154	2/4
29	D13-547	1445x340	2/4
30	D13-550	1406x190	2/4
31	D13-902A	1120x644	3/4
32	D13-904	250x373	4/4
33	D13-905	1416x405	2/4
34	D13-529	410x104	1/4
35	D13-567	1445x154	2/4

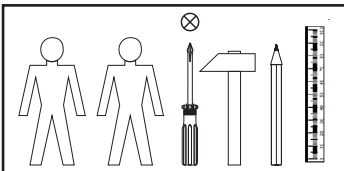

4x φ10φ5,2x20 mm o89	4x d35/1	8x φ5x17 mm d1	22x φ7x50 mm e1	88x φ8x30 mm f1	12x φ8x50 mm f6	8x k1	22x k34	8x φ50.11 mm c200
4x φ4x40 mm p10	24x φ4x35 mm p26	60x φ3,5x16 mm p38	78x φ15x12mm #16 r1	6x r10	66x r42	20x φ16 s2	1x y1	1x z1

1 

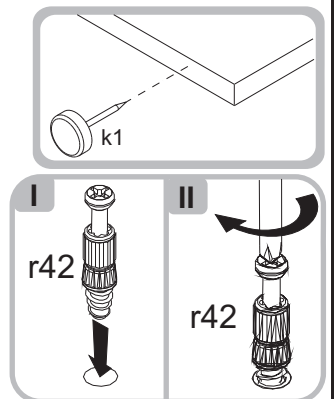
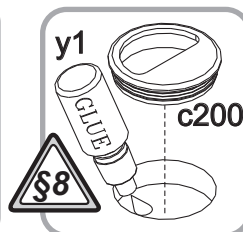
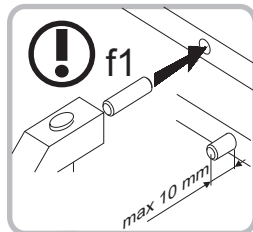
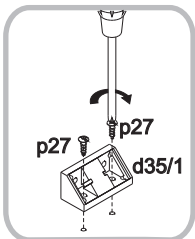
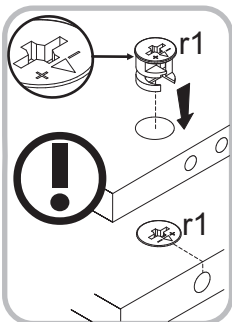
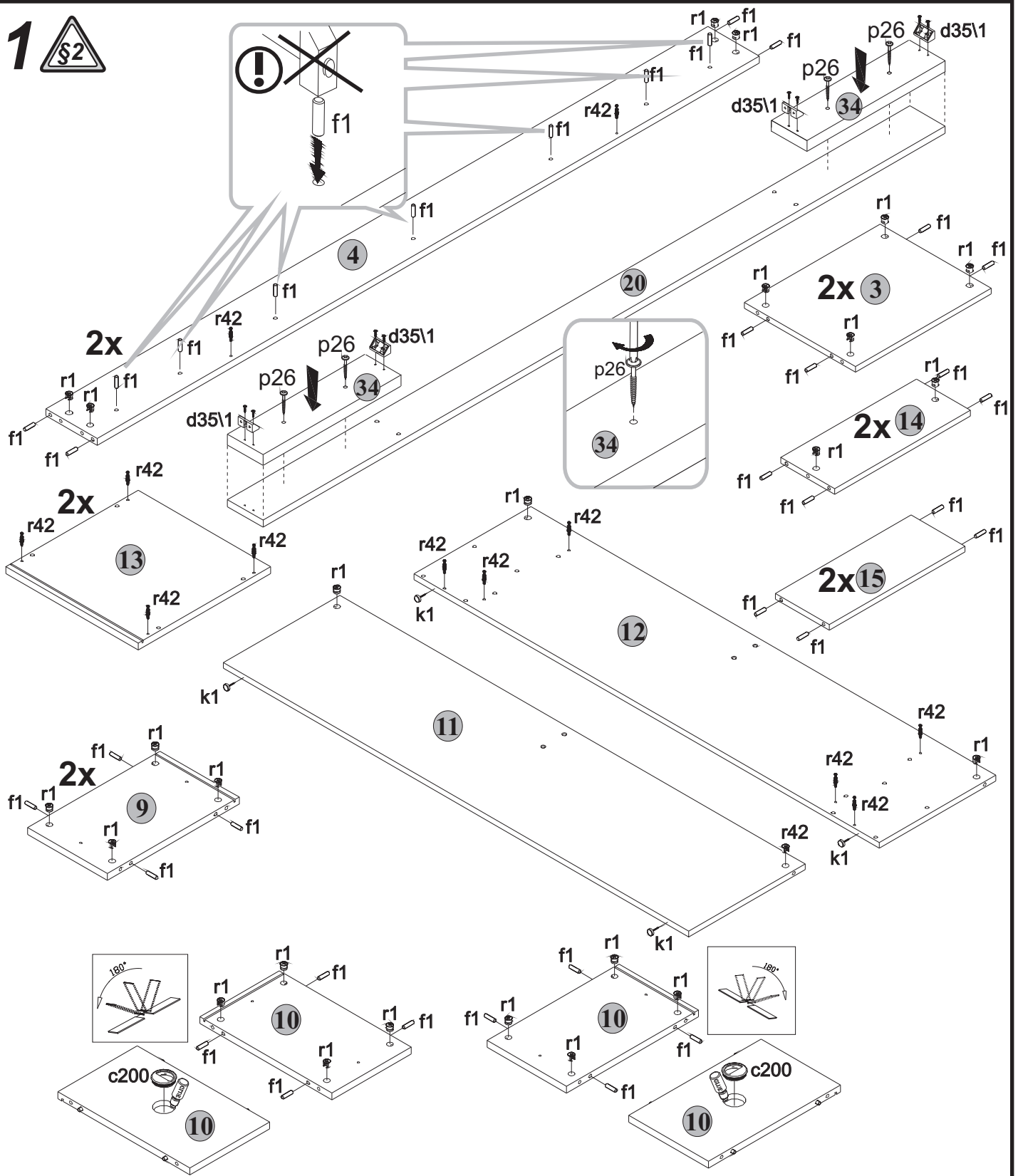

2

