

ORIENT 1  
2200-2502

F

230105

D

MONTAGEANLEITUNG  
BEDIENUNGSANLEITUNG

NL

HANDLEIDING VOOR DE MONTAGE  
GEBRUIKSAANWIJZING

TR

MONTAJ TALIMATI  
KULLANIM KLAVUZU

RO

INSTRUCȚIUNI DE INSTALARE  
INSTRUCȚIUNI DE UTILIZARE

FR

NOTICE DE MONTAGE  
MANUEL INSTRUCTIONS

HU

KÖZGYŰLÉS UTASÍTÁSOK  
KEZELÉSI UTASÍTÁS

SI

NAVODILA ZA MONTAŽO  
NAVODILA ZA UPORABO

ES

INSTRUCCIONES DE MONTAJE  
MANUAL DEL USUARIO

GB

ASSEMBLY INSTRUCTIONS  
INSTRUCTION MANUAL

PL

INSTRUKCJA MONTAŻU  
INSTRUKCJA OBSŁUGI

RU

ИНСТРУКЦИЯ ПО МОНТАЖУ  
ИНСТРУКЦИЯ ПО ЭКСПЛУАТАЦИИ

IT

ISTRUZIONI DI MONTAGGIO  
MANUALE DI ISTRUZIONI

SK

MONTÁŽNY NÁVOD  
NÁVOD NA POUŽITIE

CZ





MONTÁŽNÍ NÁVOD  
NÁVOD K POUŽITÍ

PT

INSTRUÇÕES DE MONTAGEM  
MANUAL DO USUÁRIO

HR

UPUTE ZA MONTAŽU  
UPUTE ZA UPOTREBU

|   |   |   |  |      |
|---|---|---|--|------|
| <b>Z</b> H(120-180)   | <b>X</b> H-150  | <b>q</b> M6*25  | <b>i</b> L-4   | [mm] |
|  |  |  |  |      |
| X1  | X4  | X12   | X1   |      |

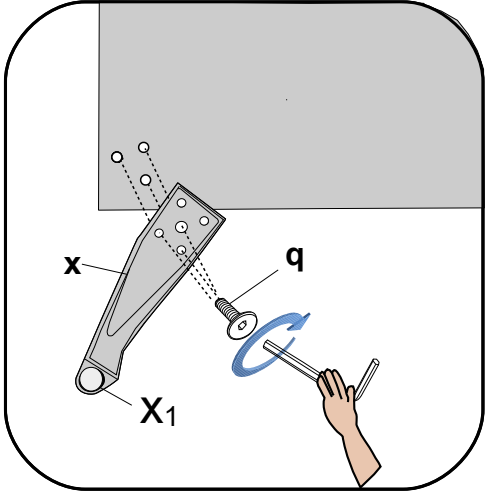
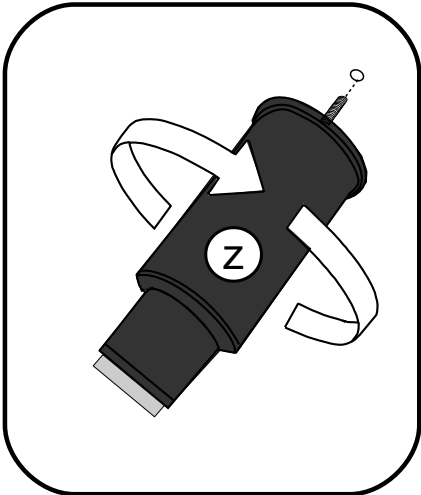
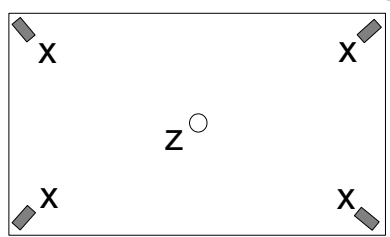
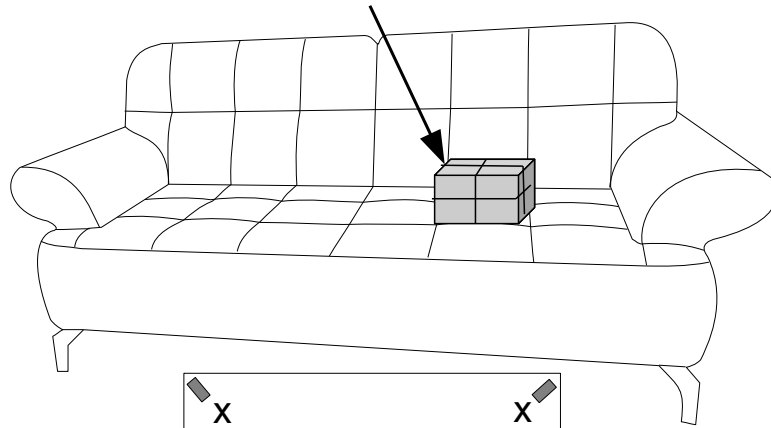

150

Clickvole Adjustable



Service · Dienstverlening · Servis · Servis · Сервисная служба · Serviciu · Services · Servizio  
 ·Servisný list · Szolgáltatás · Servisní list

Name · Naam · Nazwa · Ísim · Название · Nume · Nome · Názov · Názov ·  
 Název · Neve

**ORIENT 1**

Typ · Type · Tip · Тип · Tipo · Típus

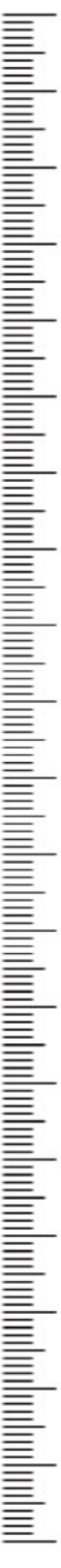
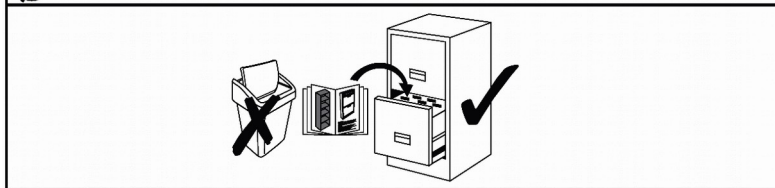
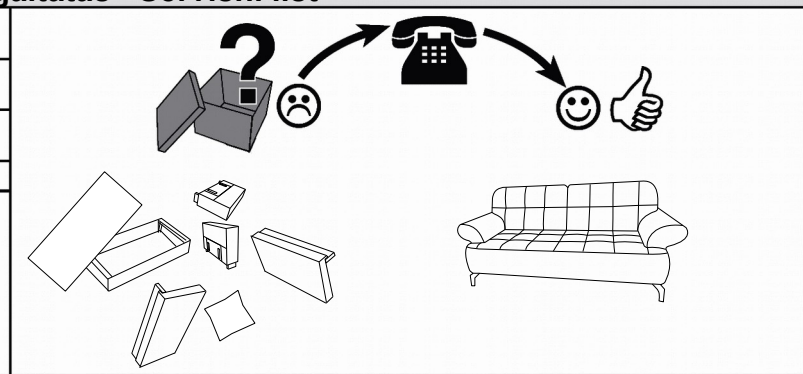

|                     |                |                |                   |
|---------------------|----------------|----------------|-------------------|
| <b>Z</b> H(120-180) | <b>X</b> H-150 | <b>q</b> M6*25 | <b>i</b> L-4 [mm] |
|                     |                |                |                   |
|                     |                |                |                   |

