

MONTAGE- UND GEBRAUCHSANLEITUNG

WORKSPACE ST

Art. 679908, 679909, 679910, 679911, 679912

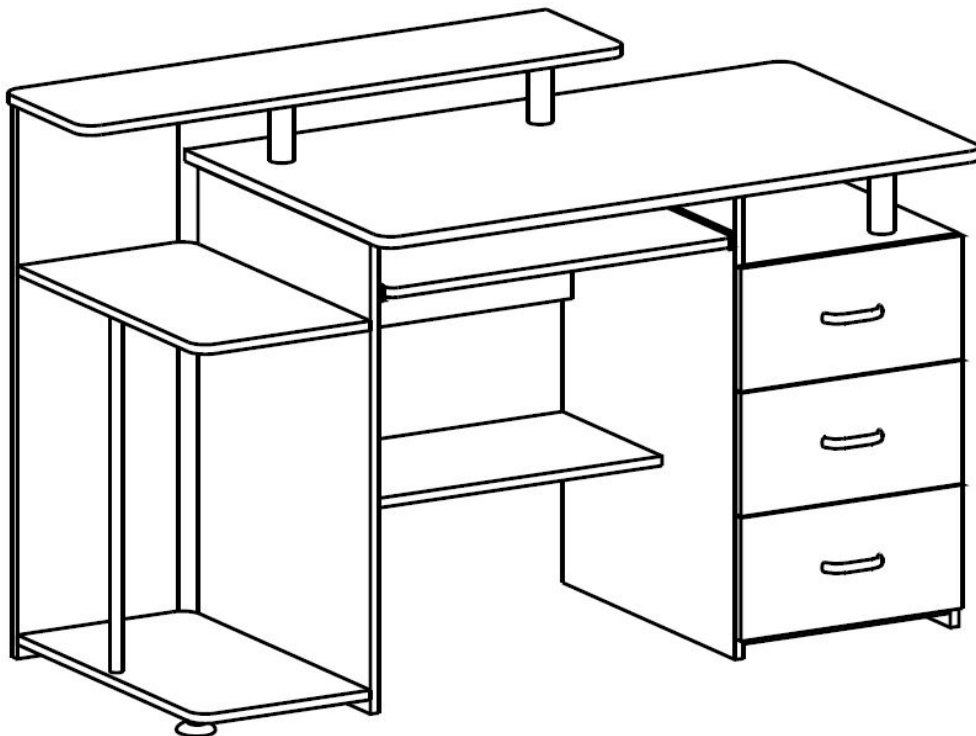

(DE) (AT) (CH)

SCHREIBTISCH

Aufbauanleitung

(GB)

DESK

assembly instructions

(FR)

BUREAU

instructions de montage

(IT)

SCRIVANIA

istruzioni di montaggio

(ES)

ESCRITORIO

Instrucciones de montaje

(NL)

BUREAU

montage-instructies

(FI)

TYÖPÖYTÄ

Kokoamisohjeet

(DK)









SKRIVEBORD

monteringsvejledning

(SE)

SKRIVBORD

monteringsanvisningar

- DE**  Bitte lesen Sie die folgende Anleitung vor der ersten Nutzung aufmerksam durch, beachten Sie dringend unsere Sicherheitshinweise auf den nachfolgenden Seiten und bewahren Sie dieses Dokument sorgfältig auf. Darstellungen können von der tatsächlichen Ausführung abweichen. Bitte beachten Sie, dass im Fall des nicht bestimmungsgemäßen Gebrauchs die Haftung erlischt.
- AT**  **CH**  Diese Anleitung, sowie sämtliche artikelspezifischen Informationen, können Sie direkt auf der Produktartikelseite einsehen (Material, Abmessungen etc.).
Hierzu geben Sie die Artikelnummer in unsere Shopsuche ein: **www.buerostuhl24.com**
- GB**  Please read the following instructions carefully before using them for the first time, urgently observe our safety instructions on the following pages and keep this document safe. Representations may differ from the actual design. Please note that liability is void in the event of improper use. You can view these instructions, as well as all item-specific information, directly on the product item page (material, dimensions etc.).
 You can view these instructions, as well as all item-specific information, directly on the product item page (material, dimensions etc.).
To do this, enter the article number in our shop search: **www.hjh-office.co.uk**
- FR**  Veuillez lire attentivement les instructions suivantes avant la première utilisation, respectez absolument nos consignes de sécurité des pages suivantes et conservez soigneusement ce document. Il se peut que les représentations diffèrent de la version réelle. Veuillez noter que notre responsabilité est annulée en cas d'utilisation non conforme.
 Ces instructions, ainsi que toutes les informations spécifiques à l'article, peuvent être consultées directement sur la page de la fiche produit (matériau, dimensions etc.).
Pour cela, indiquez le numéro de l'article dans le champ de recherche de la boutique: **www.hjh-office.fr**
- IT**  Leggere attentamente le seguenti istruzioni prima del primo utilizzo, osservare scrupolosamente gli avvisi di sicurezza presenti nelle pagine seguenti e conservare con cura questo manuale d'uso. Le illustrazioni possono differire dal modello effettivo. Si prega di notare che la garanzia decade in caso di uso improprio.
 Queste istruzioni e tutte le informazioni relative all'articolo possono essere visualizzate direttamente nella pagina prodotto (materiale, dimensioni, ecc.).
Inserire il codice articolo nella barra di ricerca: **www.hjh-office.it**
- ES**  Por favor, lea atentamente las siguientes instrucciones antes del primer uso, observe estrictamente nuestras indicaciones de seguridad en las páginas siguientes y guarde este documento en un lugar seguro. Las ilustraciones pueden diferir del diseño real. Tenga en cuenta que la responsabilidad expira en caso de uso indebido.
 Estas instrucciones, así como toda la información específica del artículo, pueden consultarse directamente en la página del artículo (material, dimensiones etc.).
Para ello, introduzca el número de artículo en el buscador de nuestra tienda: **www.hjh-office.es**
- NL**  Lees voor het eerste gebruik de volgende instructies zorgvuldig door, neem onze veiligheidsinstructies op de volgende pagina's in acht en bewaar dit document op een veilige plaats. Illustraties kunnen afwijken van het werkelijke ontwerp. Houd er rekening mee dat bij oneigenlijk gebruik de aansprakelijkheid vervalt.
 Deze instructies, en alle artikelspecifieke informatie, kunnen direct op de artikelpagina van het product worden bekeken (materiaal, afmetingen enz.).
Voer daarvoor het artikelnummer in onze winkelzoekfunctie in: **www.bureaustoel24.nl**

FI



Lue seuraava ohje tarkasti läpi ennen ensimmäistä käyttöä, noudata ehdottomasti seuraavien sivujen turvaohjeita ja säilytä tätä asiakirjaa huolellisesti. Kuvat voivat poiketa todellisesta versiosta. Ota huomioon, että määräystenvastainen käyttö mitätöi valmistajan vastuun.



Tämän ohjeen ja kaikki tuotteen tarkat tiedot löydät suoraan tuotesivulta (materiaali, mitat jne.). Löydät sivun syöttämällä tuotenumeron kaupan hakuun: www.hjh-office.fi

DK



Læs venligst følgende instruktioner omhyggeligt før første brug, overhold vores sikkerhedsinstruktioner på de følgende sider og opbevar dette dokument på et sikkert sted. Illustrationerne kan afvige fra det faktiske design. Bemærk venligst, at ansvaret bortfalder i tilfælde af forkert brug.



Disse instruktioner samt alle produktspecifikke oplysninger kan ses direkte på produktets artikelside (materiale, dimensioner osv.).

Du kan gøre dette ved at indtaste varenummeret i vores shopsøgning: www.hjh-office.dk

SE









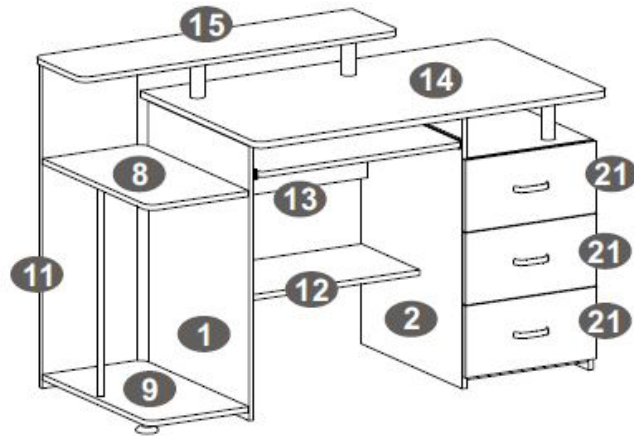









Läs igenom följande anvisningar noggrant före första användningen, följ våra säkerhetsanvisningar på följande sidor och förvara detta dokument på en säker plats. Illustrationerna kan skilja sig från den faktiska designen. Observera att vårt ansvar upphör vid felaktig användning.

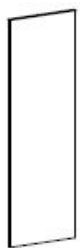

Dessa anvisningar, liksom all produktspecifik information, kan ses direkt på produktsidan (material, mått osv.). För att göra detta skriver du in artikelnumret i vår butikssökning: www.hjh-office.se



 1	 2	 3	 4
 5	 6	 7	 8
 9	 10	 11	 12
 13	 14	 15	 16

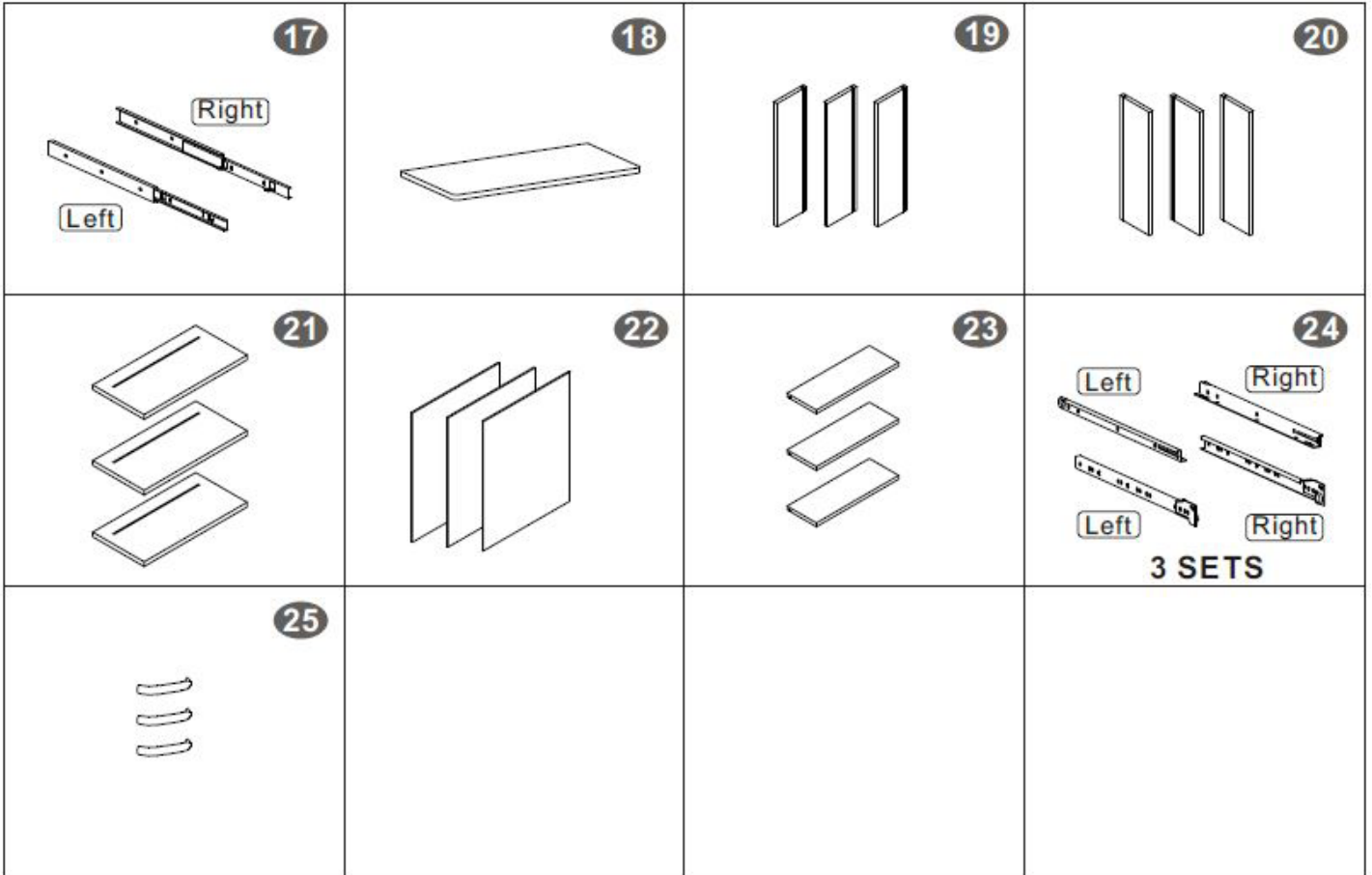

PART	QTY.	ITEM	
A	28	3X15 MM	
B	30	6X40 MM	
C	6	4X14 MM	
D	5	6X35 MM	
E	4	6X40 MM	
F	6	4X20 MM	

PART	QTY.	ITEM	
G	12	6X25 MM	
H	12	4X30 MM	
I	4		
	1		

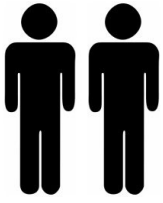

6X40MM BOLT INSTALLATION AS BELOW:

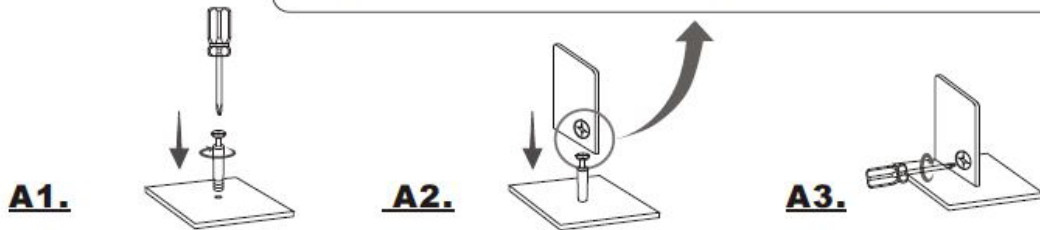
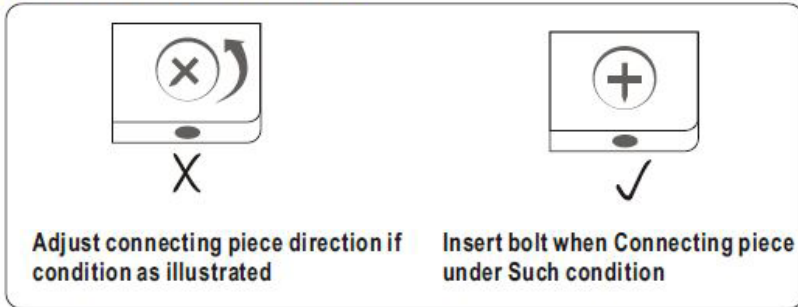
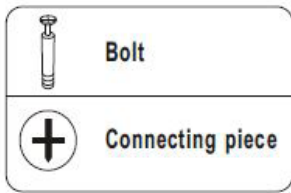

ASSEMBLY STEPS:

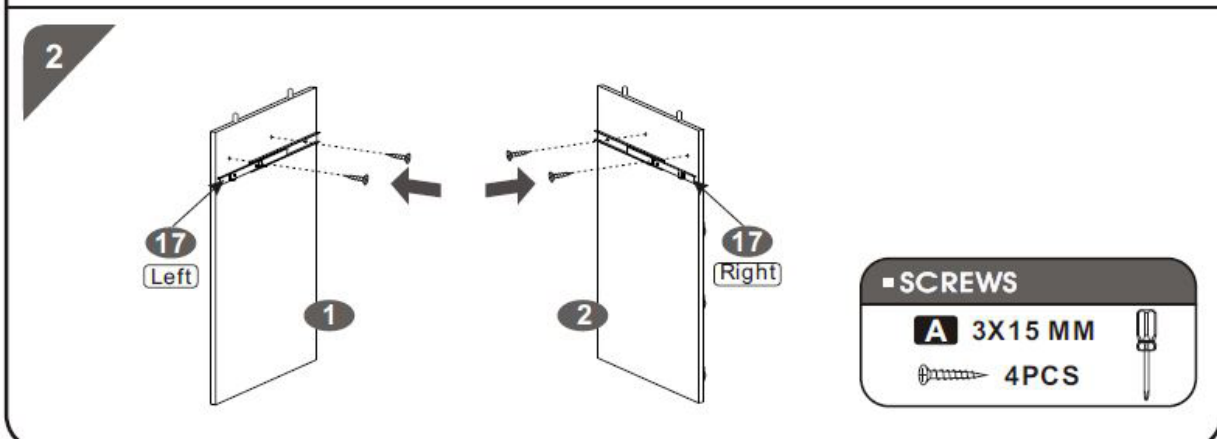
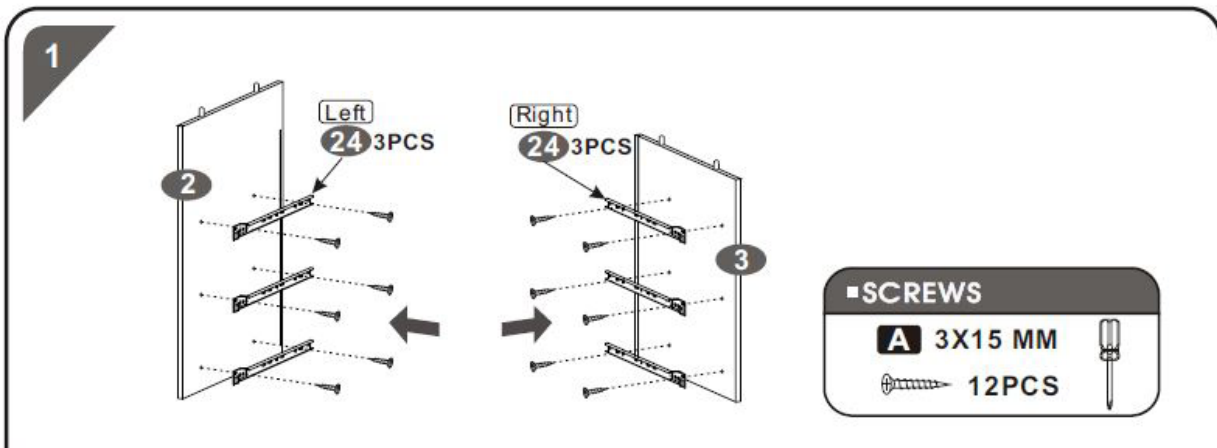

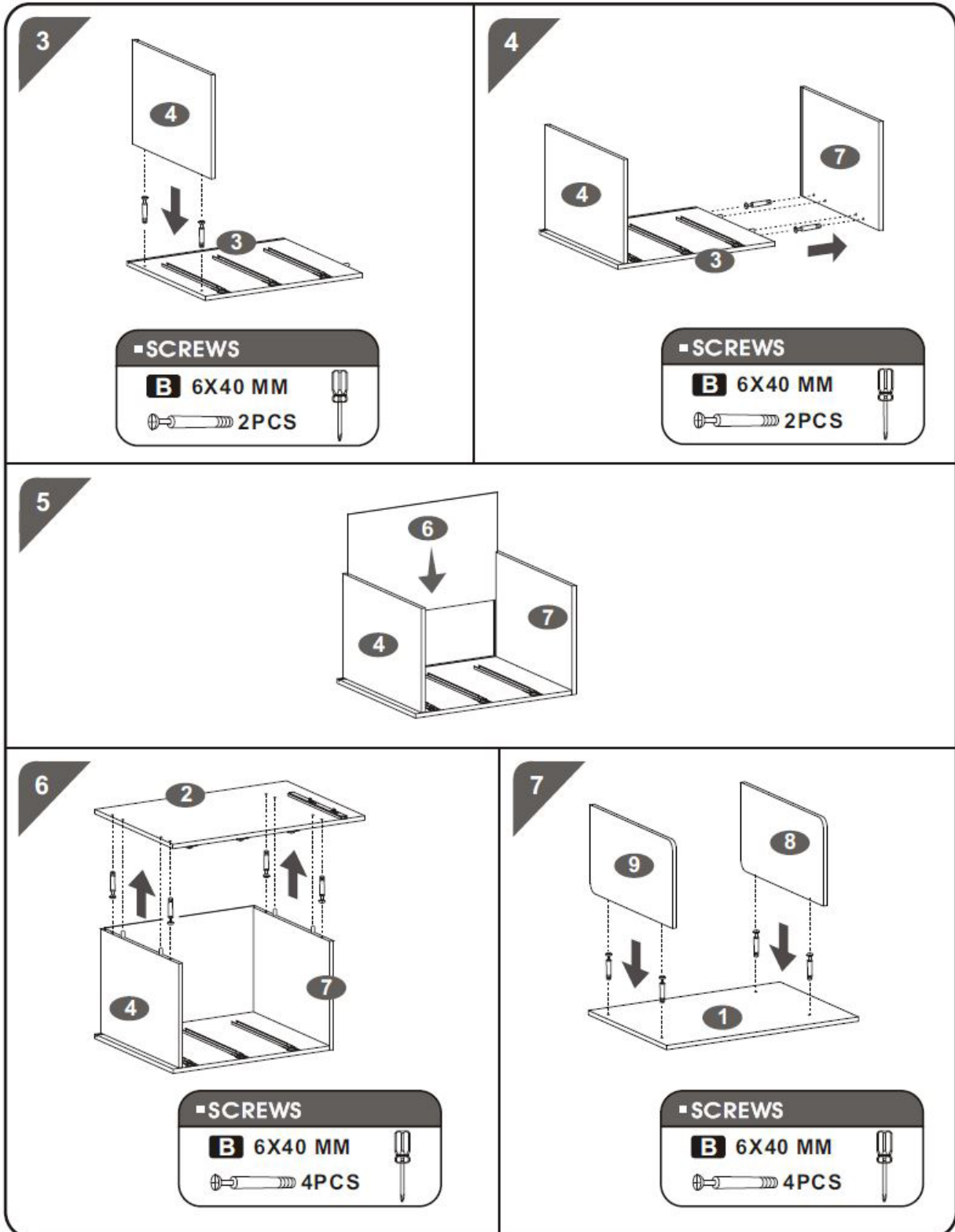
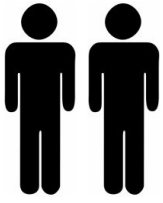

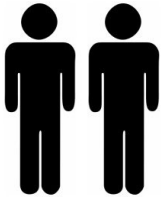

8

SCREWS

C 4X14 MM 2PCS

D 6X35 MM 1PC

9

10

SCREWS

B 6X40 MM 4PCS

11

SCREWS

B 6X40 MM 8PCS

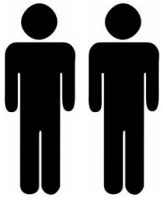

12

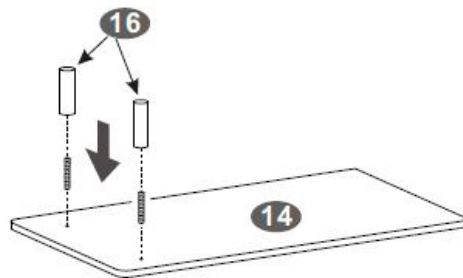

■ SCREWS

E 6X40 MM

 2PCS

13

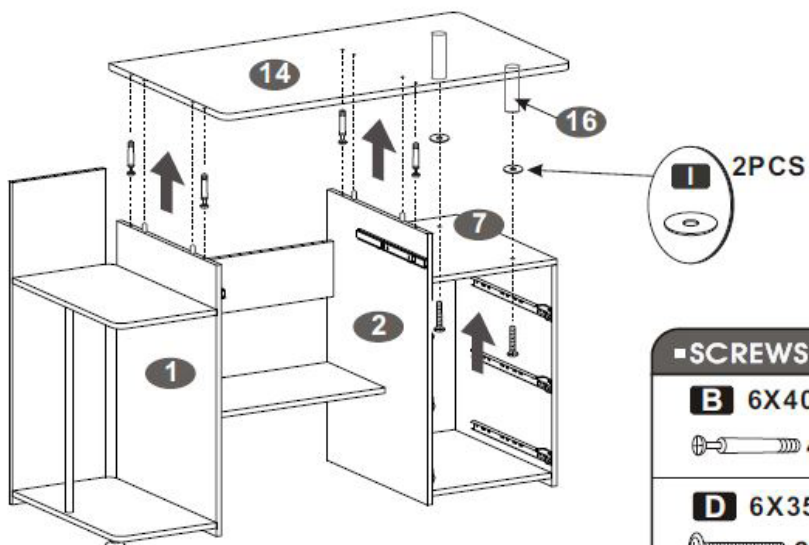

■ SCREWS

B 6X40 MM

 4PCS

D 6X35 MM

 2PCS

14

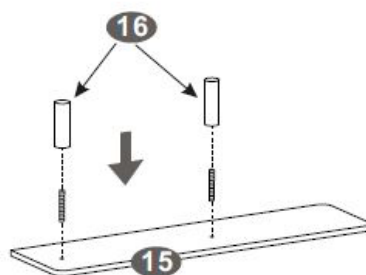

■ SCREWS

E 6X40 MM

 2PCS

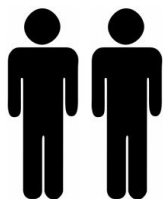

15

■ SCREWS

B 6X40 MM 2PCS

D 6X35 MM 2PCS

16

■ SCREWS

C 4X14 MM 4PCS

17

■ SCREWS

G 6X25 MM 4PCS

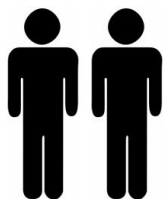

18

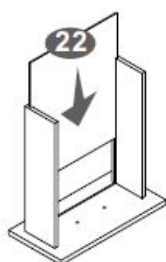

19

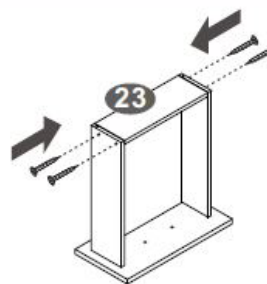

■ SCREWS

H 4X30 MM

4PCS



20

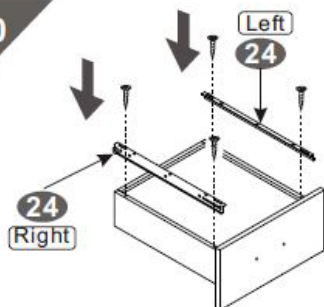

■ SCREWS

A 3X15 MM

4PCS



21

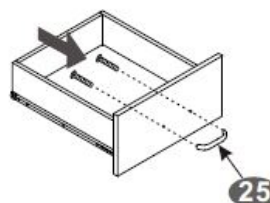

■ SCREWS

F 4X20 MM

2PCS



Repeat step 18 to step 21 to install other drawers

22

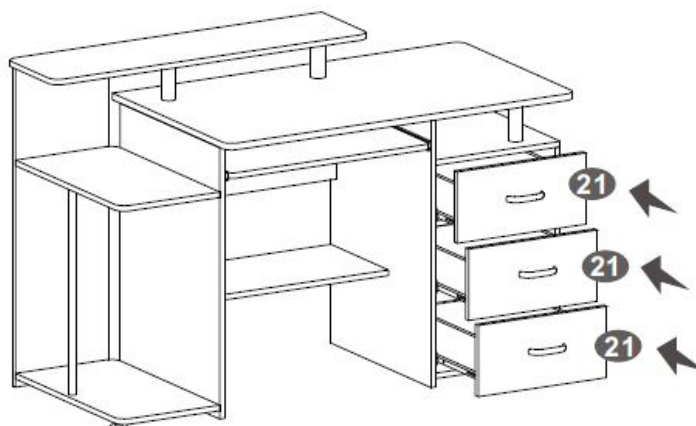

**Montage**

Packen Sie zunächst alle Teile der Lieferung aus und überprüfen Sie diese auf eventuelle Transportschäden. Beschädigte oder fehlende Teile können Sicherheit und Funktion beeinträchtigen. Fahren Sie nicht mit der Montage fort und kontaktieren Sie uns bitte.

**Nutzung und Sicherheitshinweise**

- Lassen Sie Kinder niemals unbeaufsichtigt mit dem Verpackungsmaterial. Es besteht Erstickengefahr.
- Prüfen Sie den Artikel auf Funktionen und Stabilität vor der ersten Nutzung.
- Für die private als auch für die gewerbliche Nutzung im Büro geeignet.
- Der Artikel ist kein Kletter- oder Spielgerät! Stellen Sie sicher, dass sich Personen, insbesondere Kinder, nicht an dem Artikel hochziehen oder daran anlehnen. Der Artikel kann umfallen.
- Bauen Sie den Artikel nicht ohne unsere Zustimmung um. Modifikationen des Artikels können zu Personen- Sachschäden führen.
- Wir übernehmen keine Verantwortung für entstandene Sach- oder Personenschäden bei Nichtbeachtung unserer Aufbau- Gebrauchsanleitung.

Pflege und Wartung

- Prüfen Sie regelmäßig alle Schraubverbindungen und ziehen Sie diese ggfs. nach.
- Der Artikel darf nur in einwandfreiem Zustand verwendet werden!

**Hilfe & Kontakt**

Für Fragen zu Montage, Bedienung, Reklamation oder Rückgabe kontaktieren Sie uns bitte unter:

Tel.: +49-881-924521-10

eMail: service@buerostuhl24.com

**Assembly**

First unpack all parts of the delivery and check them for any transport damage.

Damaged or missing parts can impair safety and function.

Do not proceed with the assembly and please contact us.

**Usage and safety instructions**

- Never leave children unattended with the packaging material. There is a risk of suffocation.
- Check the item for functionality and stability before using it for the first time.
- Suitable for use both at home and in the office.
- The item is not climbing or play equipment! Make sure that people, in particular children, do not pull or lean on the item. The product can fall over.
- Do not modify the item without our consent. Modifications of the product may lead to personal injury and damage to property.
- We assume no responsibility for any damage to property or personal injury in the event of non-compliance with our assembly instructions for use

Care and maintenance

- Check all screw connections regularly and retighten them if necessary.
- The product may only be used if it is in perfect condition!

**Help and Contact**

For questions about installation, operation, complaints or returns, please contact us at:

Tel.: +49-881-924521-10

eMail: service@buerostuhl24.com

**Montage**

Commencez par déballer toutes les pièces du colis et vérifiez qu'elles n'ont pas été abîmées pendant le transport. Les pièces abîmées ou manquantes peuvent nuire à la sécurité et au fonctionnement. Dans ce cas, veuillez ne pas poursuivre le montage et nous contacter.

**Utilisation et consignes de sécurité**

- Ne laissez jamais des enfants sans surveillance avec le matériel d'emballage. Il existe un risque d'étouffement.
- Vérifiez les fonctions de l'article et sa stabilité avant la première utilisation.
- Convient à la fois à un usage privé et professionnel dans un bureau.
- Cet article n'est ni un jeu d'escalade ni un jouet ! Veillez à ce que les personnes, en particulier les enfants, ne montent pas et ne s'appuient pas sur la chaise. La chaise pourrait alors basculer.
- Ne transformez pas l'article sans notre accord. Les modifications de l'article peuvent entraîner des dommages corporels et matériels.
- Nous déclinons toute responsabilité en cas de dommages matériels ou corporels

Entretien et maintenance

- Vérifiez régulièrement tous les raccords à vis et resserrez-les si besoin.
- L'article ne doit être utilisé que s'il est en parfait état !

**Help and Contact**

Pour toute question relative au montage et à l'utilisation, pour les réclamations ou les retours, veuillez nous contacter au:

Tel.: +49-881-924521-10

eMail: service@buerostuhl24.com

**Montaggio**

Per prima cosa rimuovere tutti gli elementi dell'imballaggio e controllare che i componenti non abbiano subito danni durante il trasporto.

Le parti danneggiate o mancanti potrebbero compromettere il funzionamento e la sicurezza del prodotto. Interrompere il montaggio e contattaci.

**Utilizzo e avvisi di sicurezza**

- Tenere il materiale da imballaggio fuori dalla portata dei bambini. Pericolo di soffocamento.
- Prima del primo utilizzo verificare il funzionamento e la stabilità del prodotto.
- Adatto sia per uso privato che commerciale in ufficio.
- Posizionare la sedia da ufficio su un pavimento piano e asciutto.
- Si potrebbero verificare incidenti in caso di uso improprio, ad esempio se il prodotto viene usato come sgabello o se i braccioli vengono usati come appoggio per alzarsi.
- Non ci assumiamo alcuna responsabilità per danni causati a cose o persone derivanti da una mancata osservazione delle nostre istruzioni di montaggio e di utilizzo del prodotto.

Cura e manutenzione

- Non utilizzare la sedia se le viti di collegamento sono allentate.
- L'articolo deve essere utilizzato solo se è in perfette condizioni!

**Assistenza e contatti**

Per domande relative al montaggio, funzionamento, reclami o resi, contattaci:

Tel.: +49-881-924521-10

eMail: service@buerostuhl24.com

**Montaje**

En primer lugar, desembale todas las piezas de la entrega y compruebe que no hayan sufrido daños durante el transporte.

El uso con piezas dañadas o con ausencia de piezas puede perjudicar la seguridad y el funcionamiento. En ese caso, no proceda al montaje y póngase en contacto con nosotros de inmediato.

**Instrucciones de uso y seguridad**

- Nunca deje a los niños sin supervisión con el material de embalaje. Existe riesgo de asfixia.
- Compruebe el funcionamiento y la estabilidad del artículo antes de utilizarlo por primera vez.
- Además, recomendamos el uso de una alfombrilla de protección para el suelo. Adecuada para uso privado y también para uso comercial en la oficina.
- Coloque su silla de oficina sobre un suelo nivelado y seco.
- Existe riesgo de accidente si se utiliza de forma inadecuada, por ejemplo, como ayuda para escalar o apoyándose en los reposabrazos al ponerse de pie.
- No aceptamos ninguna responsabilidad por los daños materiales o personales causados como consecuencia del incumplimiento de nuestras instrucciones de montaje.

Cuidado y mantenimiento

- Compruebe periódicamente todas las uniones atornilladas y apriételas, si es necesario.
- El artículo solo puede utilizarse en perfecto estado.

**Ayuda y contacto**

Si tiene preguntas sobre el montaje, el funcionamiento, las reclamaciones o las devoluciones, póngase en contacto con nosotros:

Tel.: +49-881-924521-10

eMail: asistencia@sillasdeoficina24.es

**Montage**

Pak eerst alle onderdelen van de levering uit en controleer ze op eventuele transportschade. Beschadigde of ontbrekende onderdelen kunnen de veiligheid en de werking nadelig beïnvloeden. Ga niet verder met de montage en neem contact met ons op.

**Gebruiks- en veiligheidsinstructies**

- Laat kinderen nooit zonder toezicht bij het verpakkingsmateriaal. Er bestaat verstikkingsgevaar.
- Controleer het voorwerp op functies en stabiliteit voordat je het voor de eerste keer gebruikt.
- Geschikt voor zowel particulier als commercieel gebruik op kantoor.
- Zet de bureaustoel op een vlakke, droge vloer.
- Als de stoel verkeerd gebruikt wordt, bijvoorbeeld als klimhulpmiddel of door op de armleuningen te steunen, bij het opstaan, is er kans op ongelukken.
- Wij aanvaarden geen verantwoordelijkheid voor schade aan eigendommen of persoonlijk letsel veroorzaakt door het niet in acht nemen van onze montage-instructies.

Verzorging en onderhoud

- Controleer regelmatig alle schroefverbindingen en draai ze zo nodig aan.
- Het artikel mag alleen in perfecte staat worden gebruikt!

**Hulp & contact**

Voor vragen over montage, bediening, klachten of retourzendingen kun je contact met ons opnemen:

Tel.: +49-881-924521-10

eMail: service@buerostuhl24.com

**Asennus**

Pura aluksi kaikki toimituksen osat paketista ja tarkasta ne kuljetusvaurioiden varalta. Vaurioituneet tai puuttuvat osat voivat heikentää turvallisuutta ja toimivuutta. Älä jatka asennusta ja ota yhteyttä meihin.

**Käyttö ja turvaohjeet**

- Älä koskaan jätä lapsia valvomatta pakkausmateriaalin kanssa. Niihin liittyy tukehtumisvaara.
- Tarkasta tuotteen toiminnot ja vakaus ennen ensimmäistä käyttöä.
- Sopii sekä koti- että toimistokäyttöön.
- Aseta toimistotuoli tasaiselle, kuivalle lattialle.
- Väärä käyttö esimerkiksi nousuapuna tai käsinojiin nojautuminen seisomaan noustessa voi aiheuttaa onnettomuuden.
- Emme ota vastuuta aineellisista tai henkilövahingoista, jos kokoamis- ja käyttöohjeitamme ei ole noudatettu.

Hoito ja huolto

- Tarkasta säännöllisesti kaikki ruuviliitokset ja kiristä ne tarvittaessa.
- Tuotetta saa käyttää vain, kun se on moitteettomassa kunnossa!

**Tuki ja yhteystiedot**

Ota meihin yhteyttä asennukseen, käyttöön, reklamaatioihin tai palautukseen liittyvissä kysymyksissä:

Tel.: +49-881-924521-10

eMail: service@buerostuhl24.com

**Samling**

Pak først alle dele af leveringen ud, og kontrollér dem for eventuelle transportskader. Beskadigede eller manglende dele kan forringe sikkerheden og funktionen. Fortsæt ikke med monteringen, og kontakt os venligst.

**Benyttelse og sikkerhedsoplysninger**

- Lad aldrig børn være uden opsyn med emballagematerialet. Der er risiko for kvælning.
- Kontroller, at produktet fungerer og er stabilt, før du bruger det første gang.
- Velegnet til både privat og erhvervsmæssig brug på kontoret.
- Placer kontorstolen på et plant, tørt gulv.
- I tilfælde af forkert brug, f.eks. som klatrehjælp eller ved at støtte på armlænene, når du rejser dig op, er der risiko for ulykker.
- Vi påtager os intet ansvar for eventuelle skader på ejendom eller personskade forårsaget af manglende overholdelse af vores monteringsvejledning.

Pleje og vedligeholdelse

- Kontroller alle skrueforbindelser regelmæssigt, og stram dem om nødvendigt.
- Produktet må kun anvendes i perfekt stand!

**Hjælp og kontakt**

For spørgsmål vedrørende montering, betjening, reklamationer eller returnering bedes du kontakte os på:

Tel.: +49-881-924521-10

eMail: service@buerostuhl24.com

**Montering**

Packa först upp alla delar av leveransen och kontrollera att de inte har några transportskador. Skadade eller saknade delar kan försämra säkerheten och funktionen. Fortsätt inte med monteringen utan kontakta oss.

**Bruks och säkerhetsanvisningar**

- Låt aldrig barn komma åt förpackningsmaterialet. Det finns risk för kvävning.
- Kontrollera att produkten fungerar och är stabil innan du använder den för första gången.
- Lämplig både i hemmet och på kontoret.
- Placera kontorsstolen på ett plant, torrt golv.
- Vid felaktig användning, t. ex. som hjälp att ta sig upp eller om man lutar sig på armstöden när man ställer sig upp finns det risk för olyckor.
- Vi tar inget ansvar för skador på egendom eller personskador som orsakas av Bristande efterlevnad av våra monteringsanvisningar.

Skötsel och underhåll

- Kontrollera regelbundet att alla skruvar är åtdragna och dra åt dem vid behov.
- Artikeln får endast användas i perfekt skick!

**Hjälp och kontakt**

För frågor om montering, användning, klagomål eller returer, vänligen kontakta oss på:

Tel.: +49-881-924521-10

eMail: service@buerostuhl24.com