

**INSTRUCTION MANUAL/BEDIENUNGSANLEITUNG/NOTICE D'UTILISATION/
MANUAL DE INSTRUCCIONES DE USO/MANUALE DI ISTRUZIONI**



WARNING!

Adults assembly required.
During assembly, keep all
parts away from children.
Check regularly to ensure
all fasteners are tight.



WARNUNG!

Die Montage ist von
Erwachsenen durchzuführen.
Halten Sie während der
Montage alle Teile von Kindern
fern.
Überprüfen Sie regelmäßig
den festen Sitz der Schrauben.



Attention !

Montage à effectuer par
des adultes.
Pendant le montage, tenez
les éléments
éloignés des enfants.
Vérifiez régulièrement que
toutes les vis
soient serrées.



¡Atención!



Se requiere que el montaje sea
llevado a cabo por un adulto.
Durante el montaje, mantenga
todas las piezas fuera del
alcance de los niños.
Verifique regularmente que
todos los tornillos estén
correctamente apretados.



avvertimento

L'assemblaggio deve essere
effettuato da adulti.
Durante il montaggio
mantenere tutti i pezzi lontano
dalla portata dei bambini.
Controllare regolarmente per
assicurarsi che tutte le
chiusure siano ben strette.

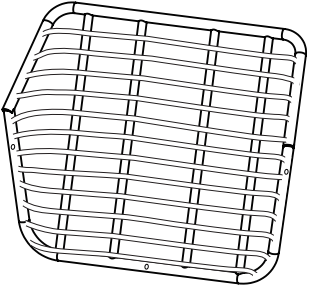
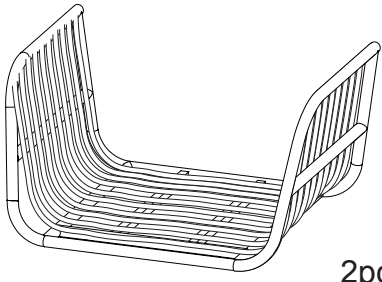
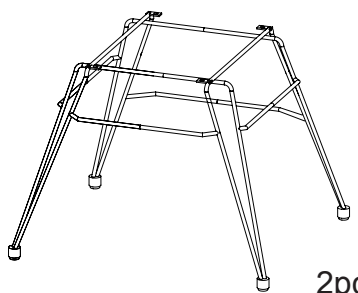
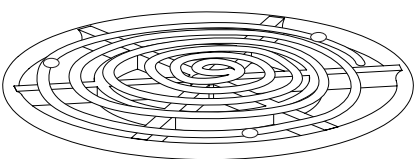
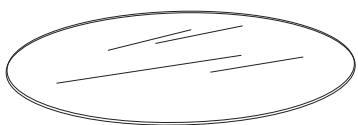
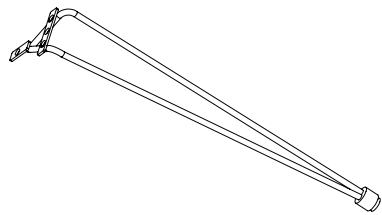
PARTS LIST/STÜCKLISTE/PARTS LIST/LISTA DE PIEZAS/LISTA DEI PEZZI

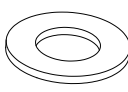
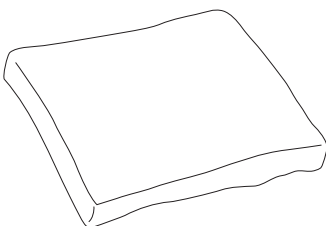
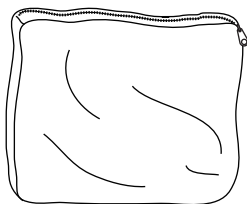
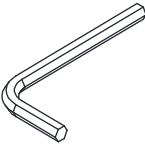
<p>A</p>  <p>2pcs</p>	<p>B</p>  <p>2pcs</p>	<p>C</p>  <p>2pcs</p>
<p>D</p>  <p>1pc</p>	<p>E</p>  <p>1pc</p>	<p>F</p>  <p>3pcs</p>
<p>G</p>  <p>M6x15</p> <p>14pcs</p>	<p>H</p>  <p>M6x35</p> <p>6pcs</p>	<p>I</p>  <p>M6</p> <p>20pcs</p>
<p>J</p>  <p>2pcs</p>	<p>J1</p>  <p>2pcs</p>	<p>K</p>  <p>1pc</p>

**RETAIN FOR FUTURE REFERENCE
FÜR KÜNFTIGE VERWENDUNG AUFBEWAHREN
A CONSERVER POUR UNE UTILISATION FUTURE
CONSERVAR PARA SER LEÍDO POR CADA NUEVO USUARIO,
ANTES DE UTILIZAR EL ARTÍCULO POR PRIMERA VEZ
CONSERVARE PER CONSULTAZIONI FUTURE**

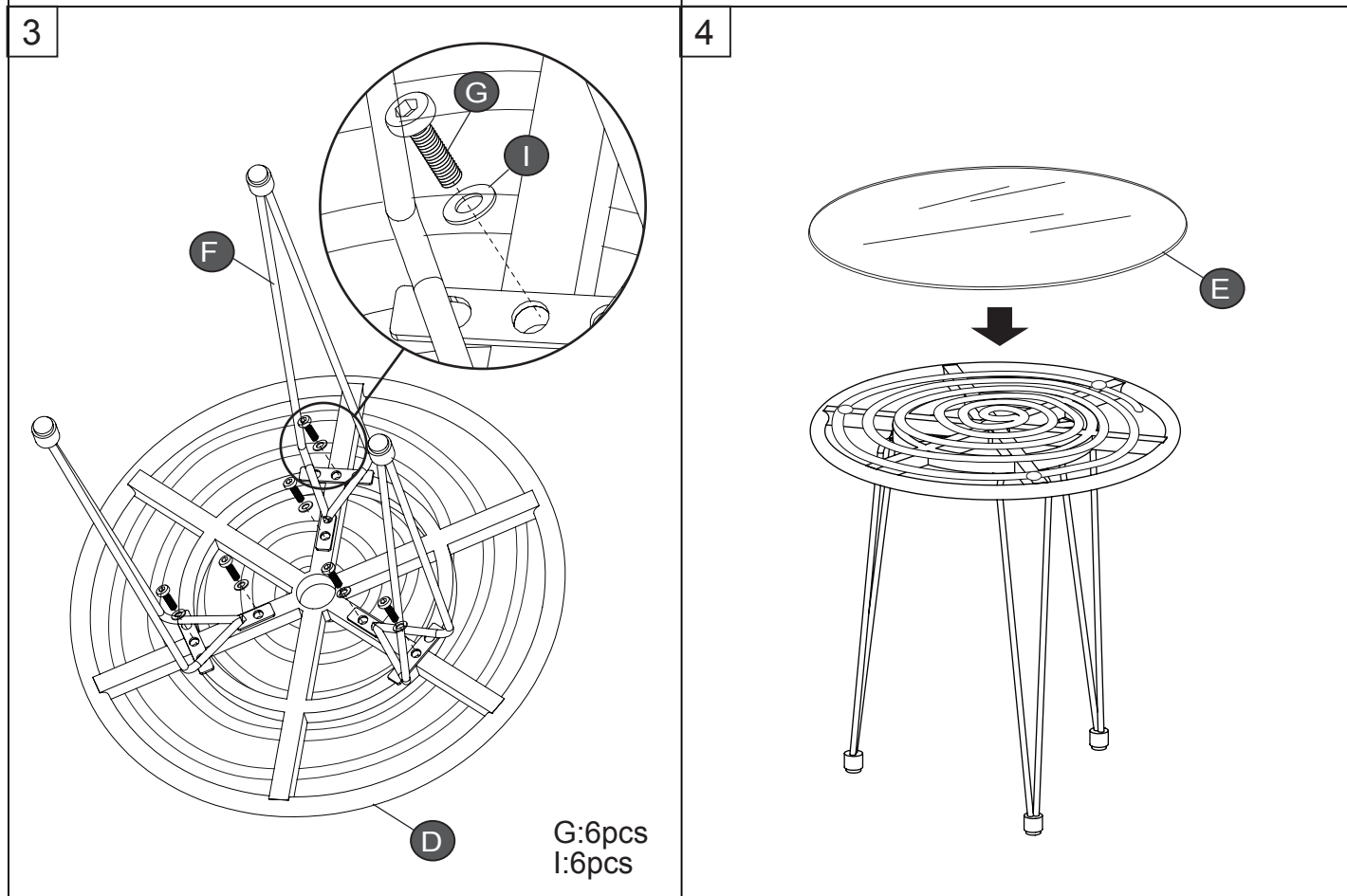
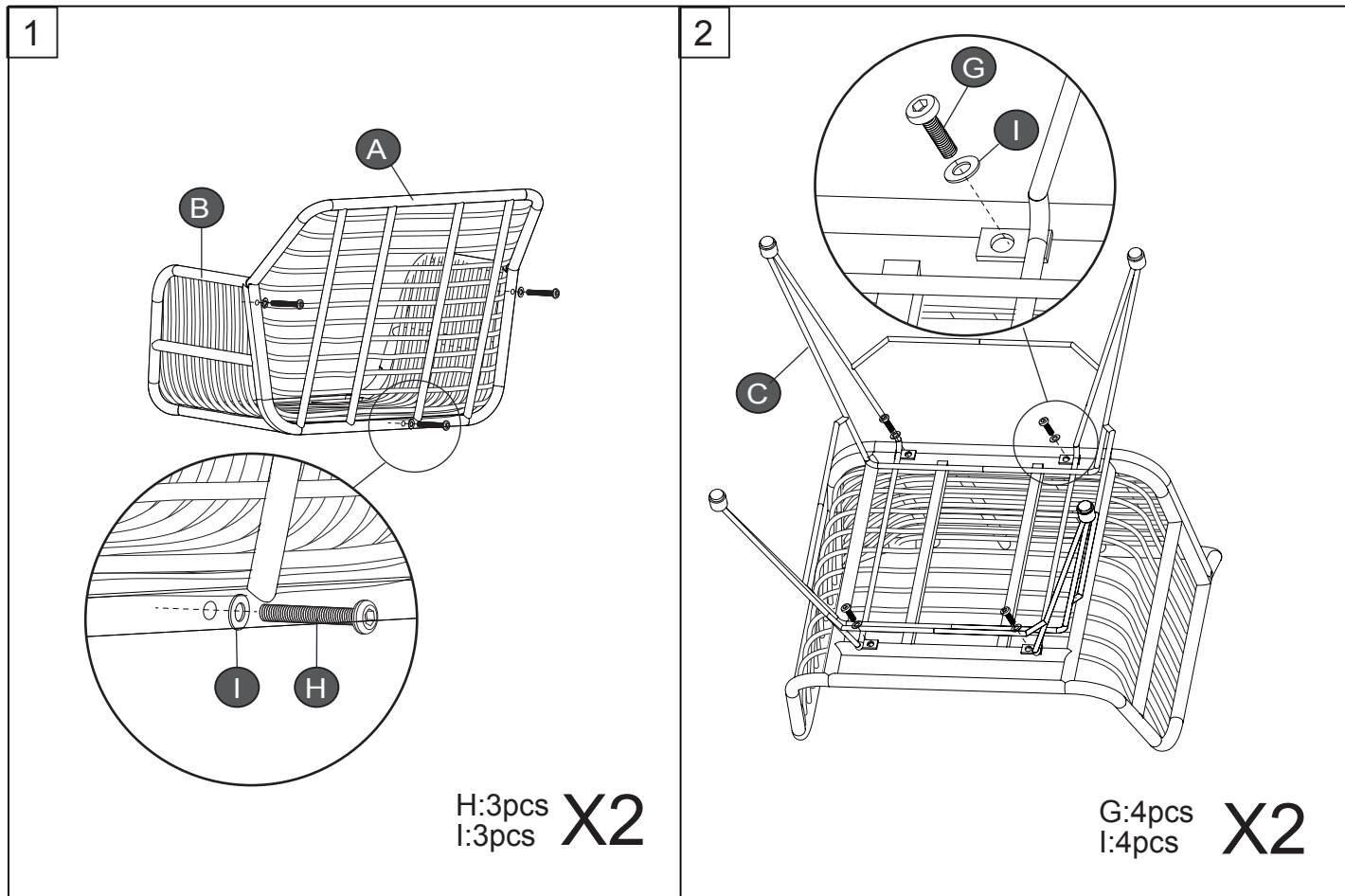

Tight all the screws to 60% first then tight to 100%.
 Während der Montage alle Schrauben zuerst 60% anziehen, dann zu 100%.
 Serrez toutes les vis à 60% d'abord puis serrez à 100%.
 Primero apriete los tornillos al 60% y después al 100%.
 Stringere le viti dapprima al 60% e successivamente completamente al 100%.

5

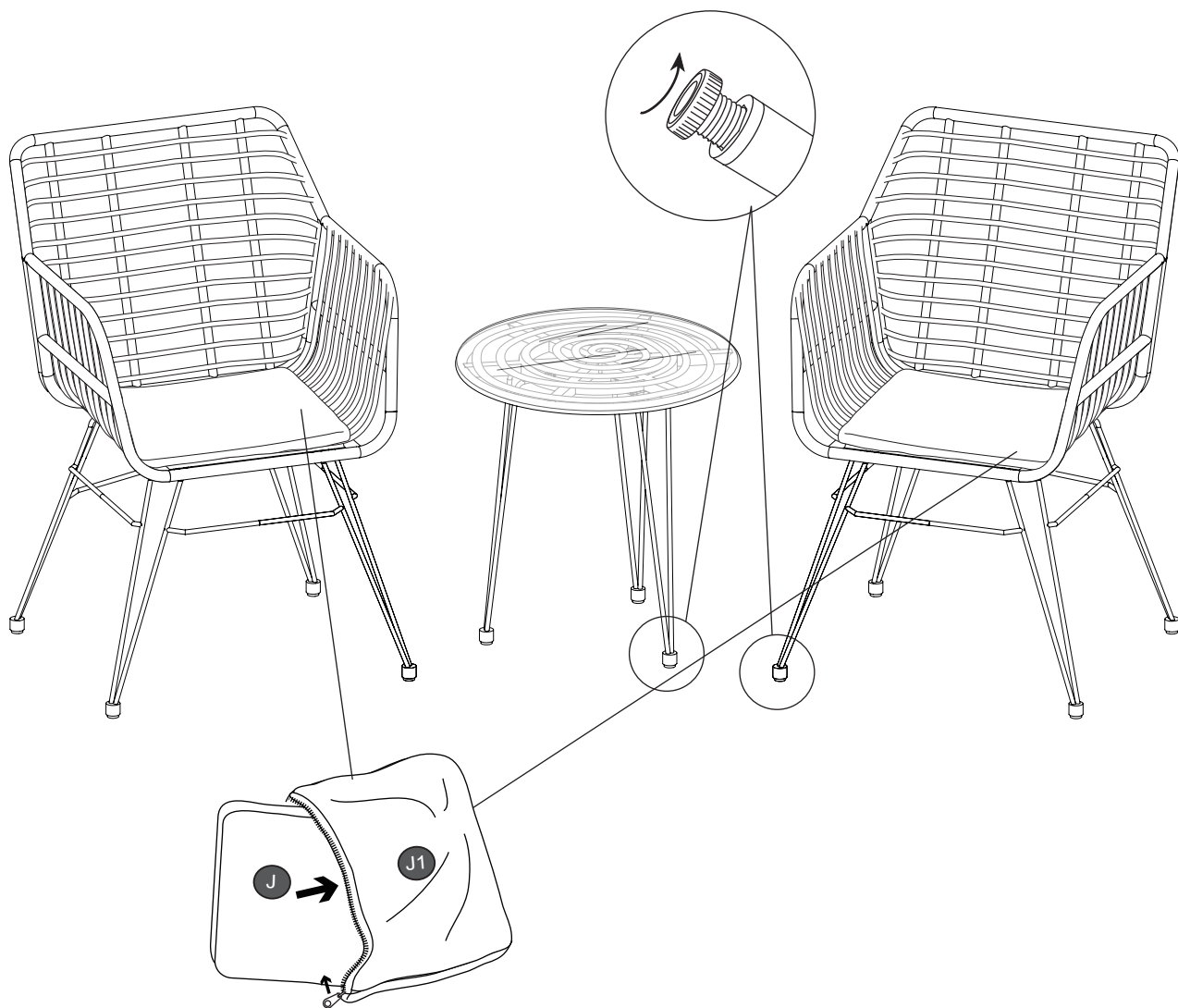

Tight all the screws to 60% first then tight to 100%.
Während der Montage alle Schrauben zuerst 60% anziehen, dann zu 100%.
Serrez toutes les vis à 60% d'abord puis serrez à 100%.
Primero apriete los tornillos al 60% y después al 100%.
Stringere le viti dapprima al 60% e successivamente completamente al 100%.