

A	B	C (mm)		D
1	M222-0010	1884	316	3/3
2	M222-0011	1884	316	3/3
3	M222-1015	1950	364	2/3
4	M222-1016	1950	364	2/3
5	M222-2006	802	400	1/3
6	M222-3018	768	344	1/3
7	M222-3019	767	334	1/3
8	M222-5010	1950	80	2/3
9	M222-5011	1950	80	2/3
10	M222-9305	1893	779	3/3

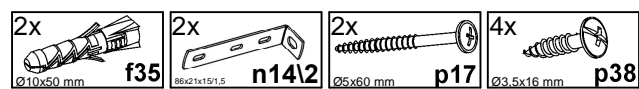

1 §2

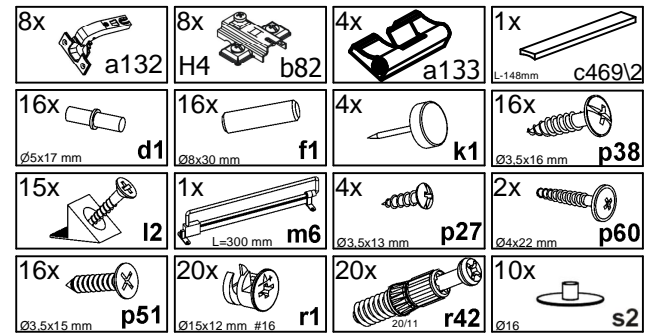
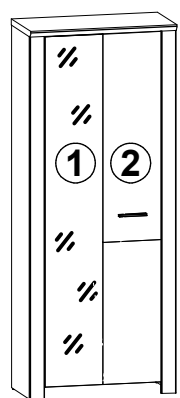
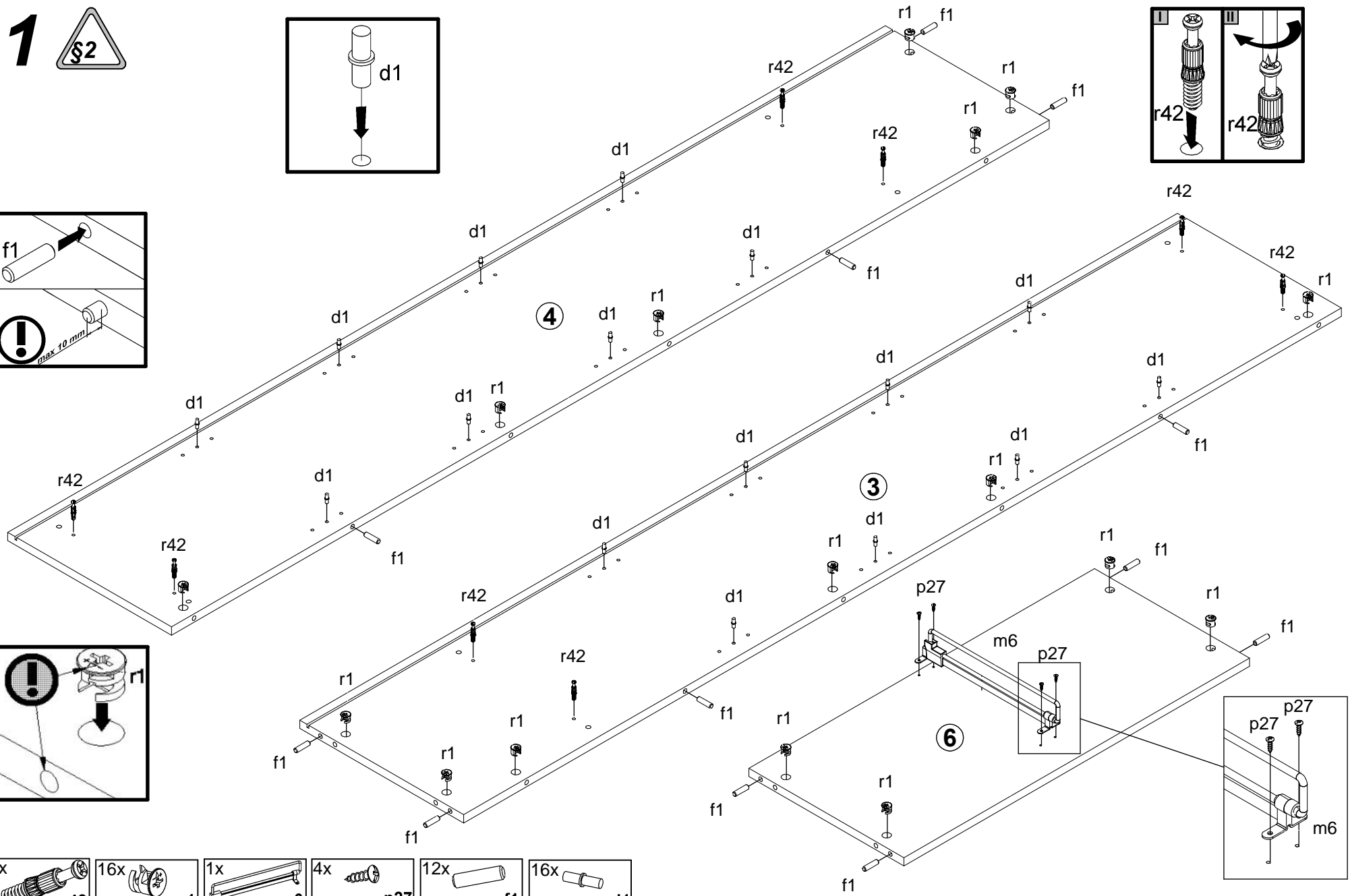
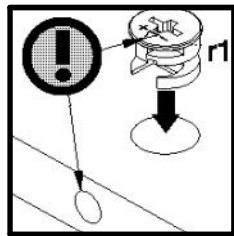
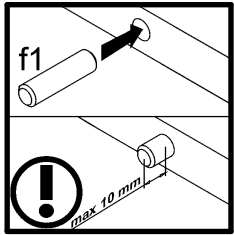
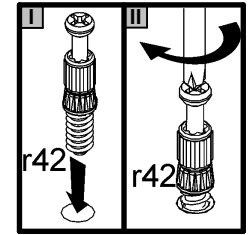
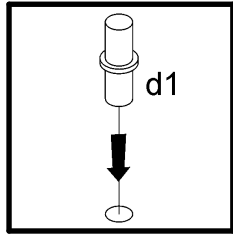

- 8x r42
- 16x r1
- 1x f1
- 4x p27
- 12x f1
- 16x d1
- m6 L=300 mm
- p27 Ø3,5x13 mm
- f1 Ø8x30 mm
- d1 Ø5x17 mm



1

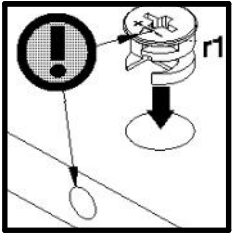
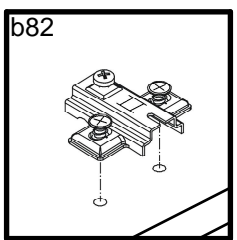
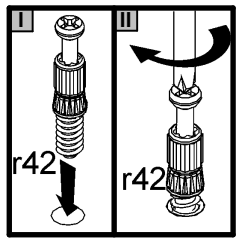
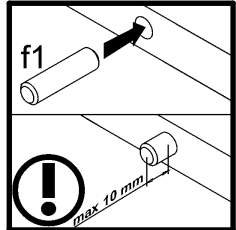
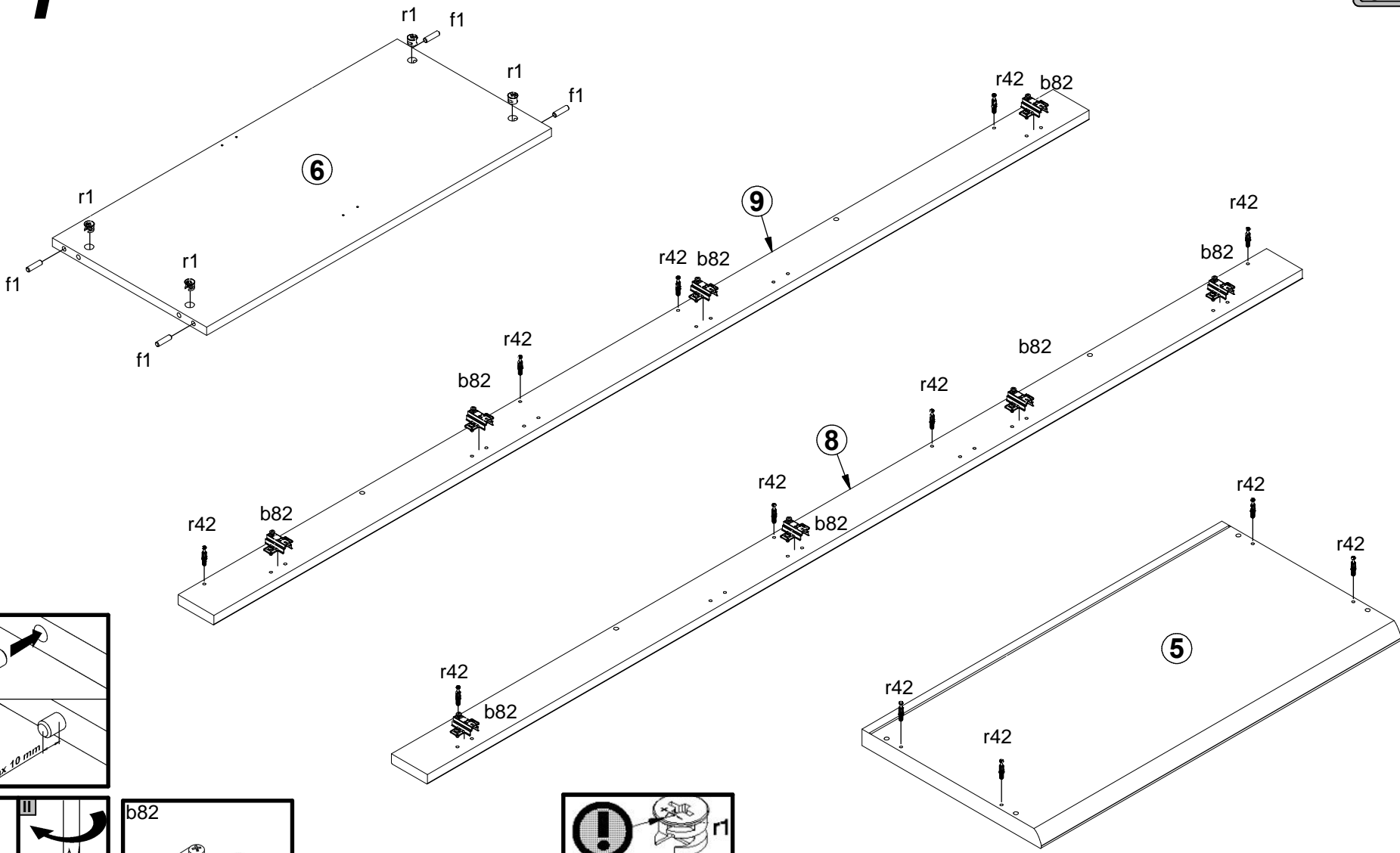

8x  
H4

4x  
Ø8x30 mm

4x  
Ø15x12 mm #16

12x  
20/11

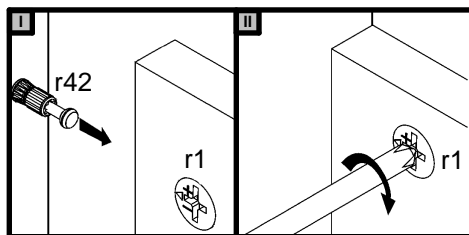
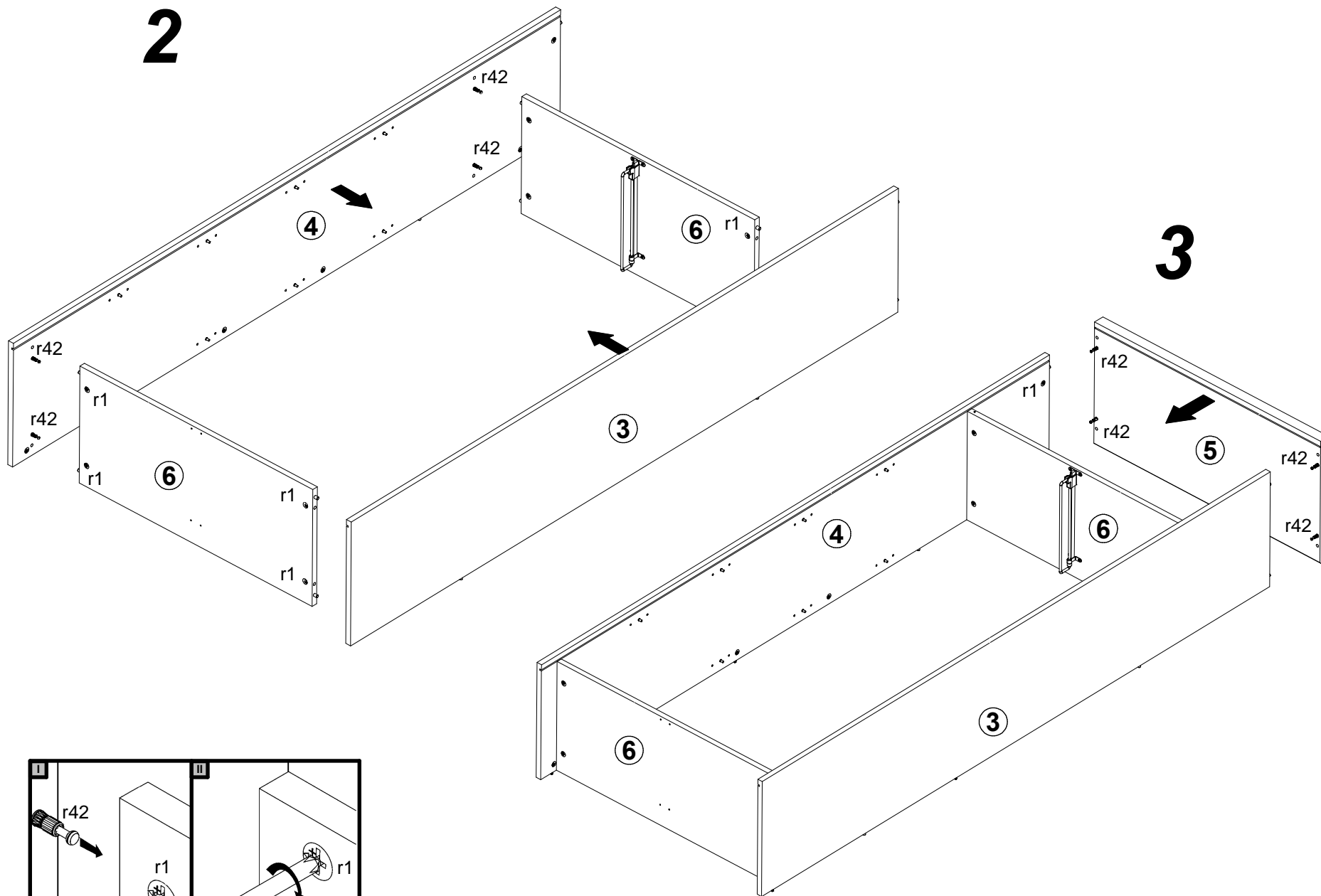

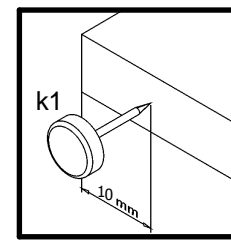
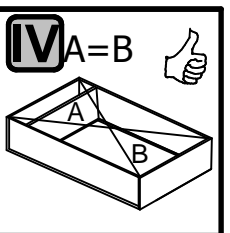
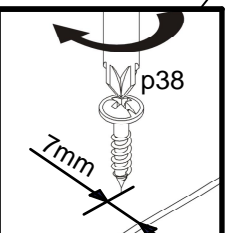
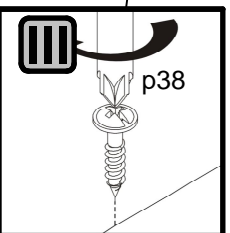
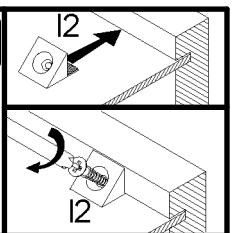
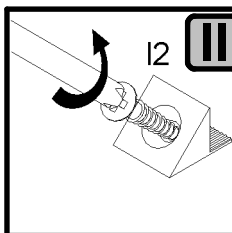
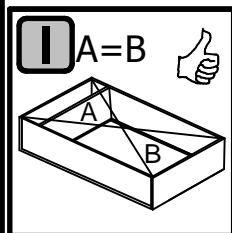
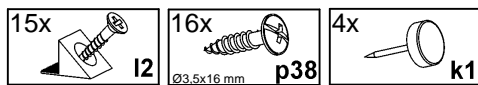
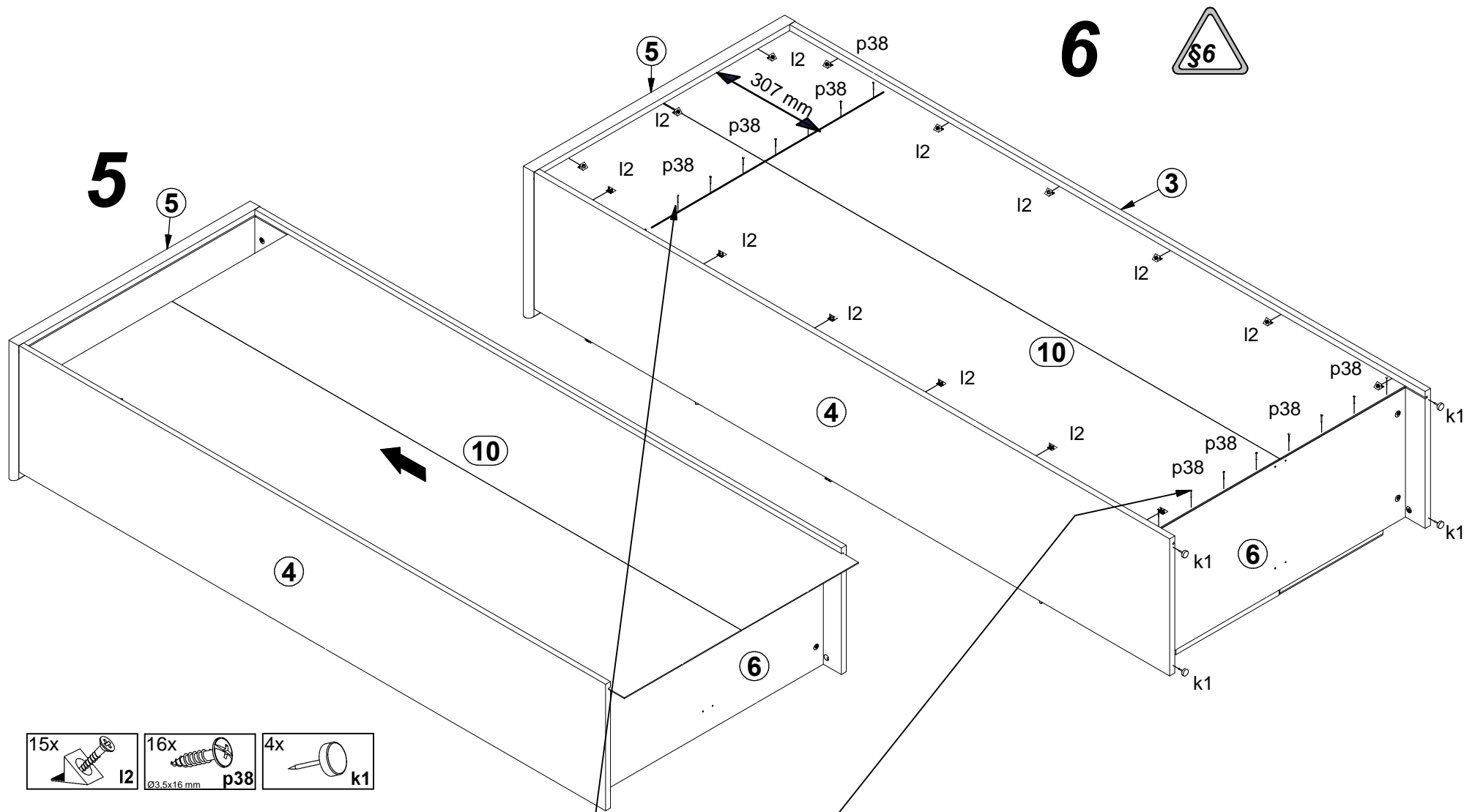

7

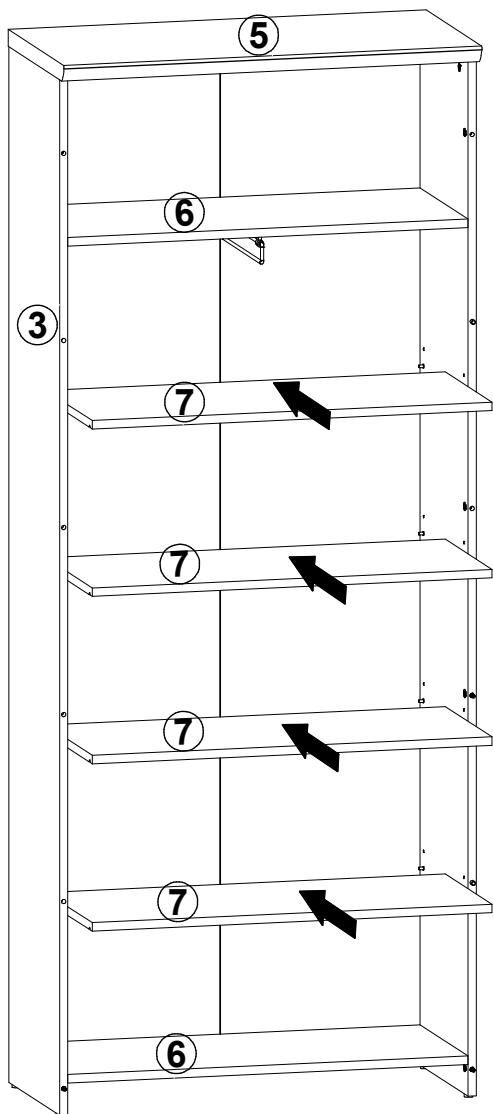

8

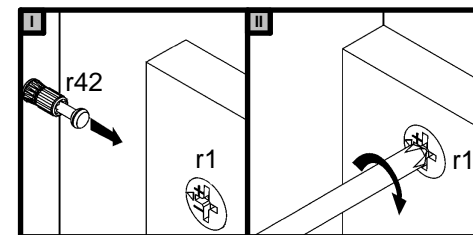
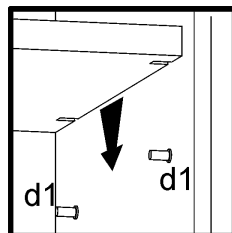
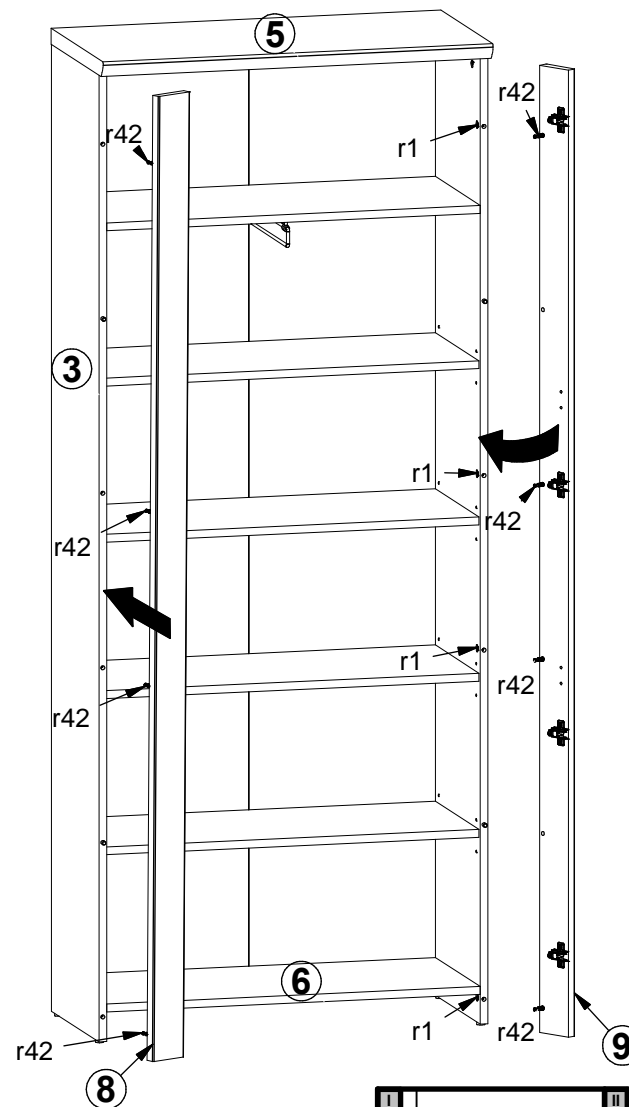

9

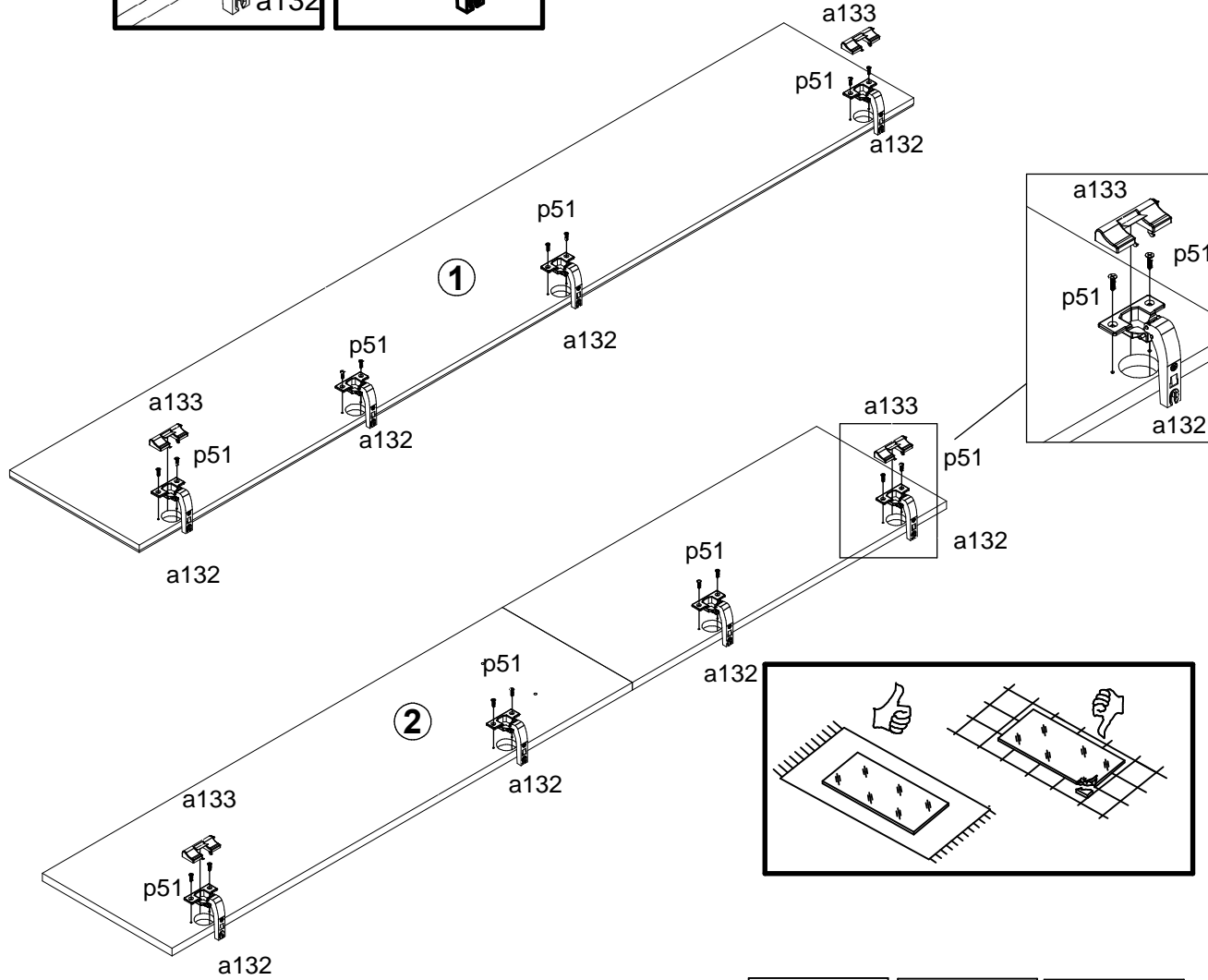
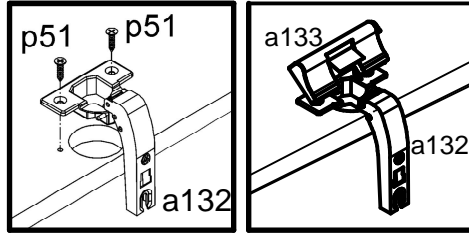

- 8x a132
- 4x a133
- 16x Ø3,5x15 mm p51

10

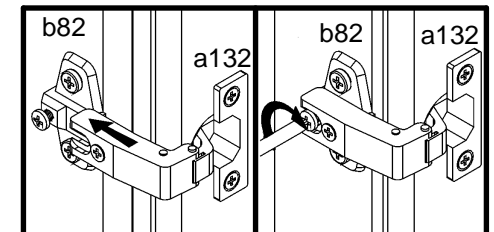
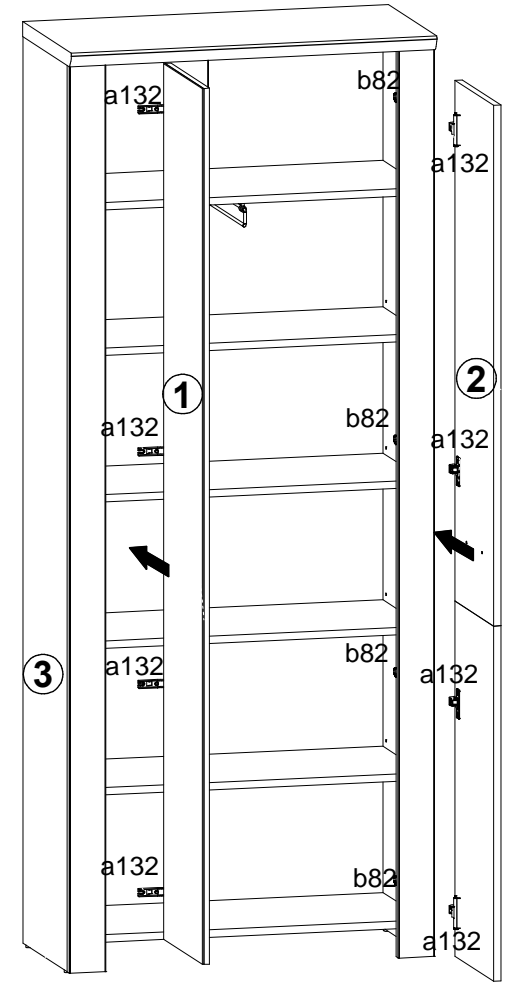



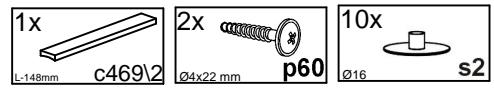

11

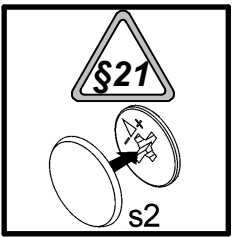
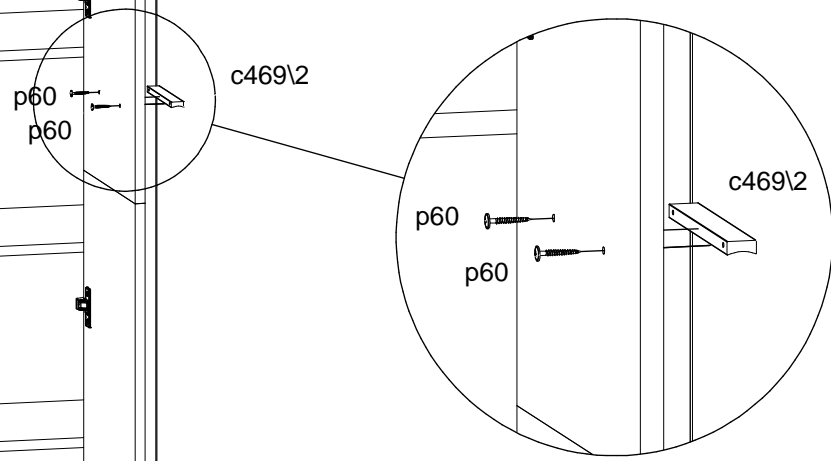
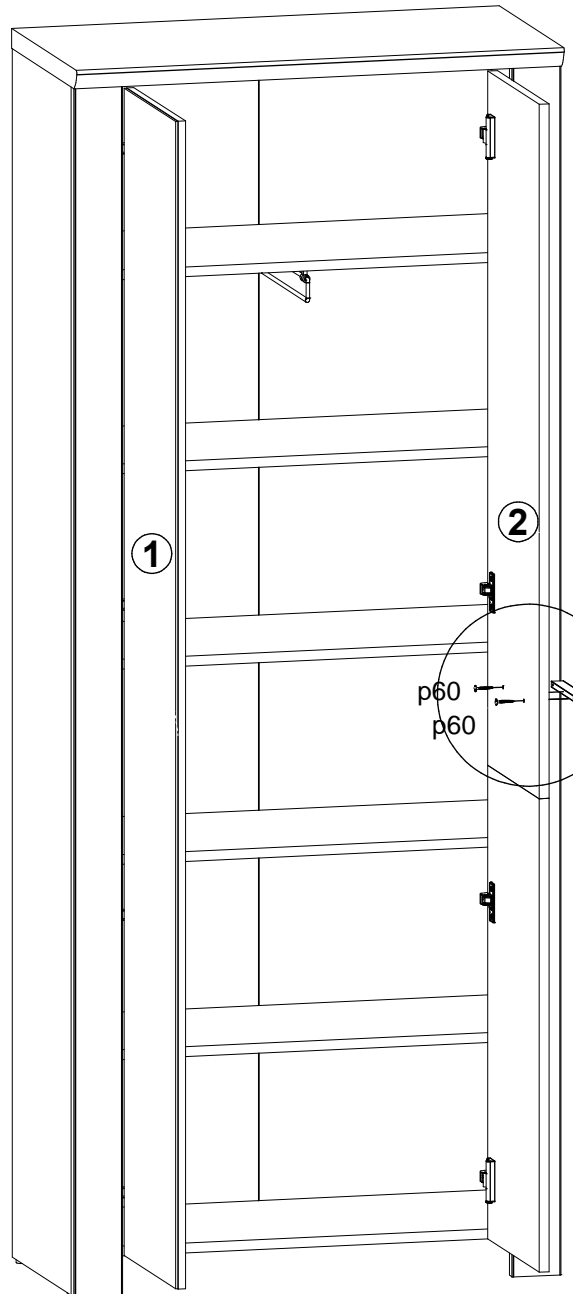

# 12

