





Aufbauanleitung

A  M3.5X60=6+1 Stück

B  M3.5X45=14+1 Stück

C  M3.5X35=12+1 Stück

D  M3.5X25=4+1 Stück

E  M3.0X16=14+1 Stück

F  M6X50=8+1 Stück

G  M3.0X15=1 Stück

 X2 Stück

 X1 Stück

1

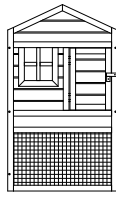

1 Stück

2

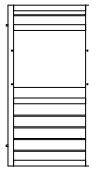

1 Stück

3

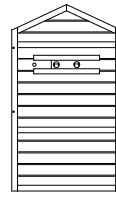

1 Stück

4

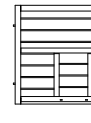

1 Stück

5

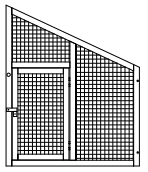

1 Stück

6

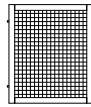

1 Stück

7

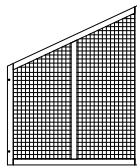

1 Stück

8



1 Stück

9



1 Stück

10



1 Stück

11



1 Stück

12



1 Stück

13

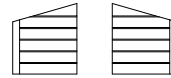

1 Stück

14



1 Stück

15



1 Stück

16



1 Stück

17

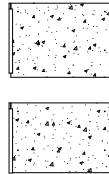

1 Stück

18

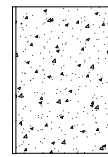

1 Stück

19



1 Stück

20



1 Stück

Schritt 1:

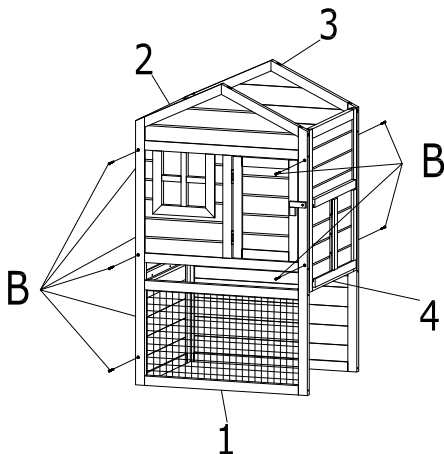

Schritt 2:

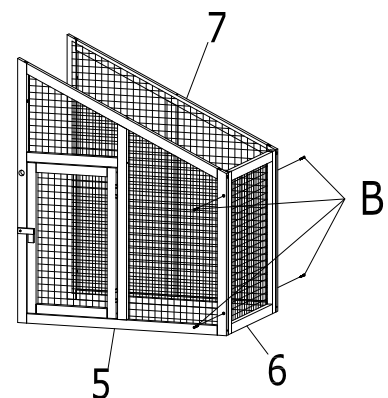

Schritt 3:

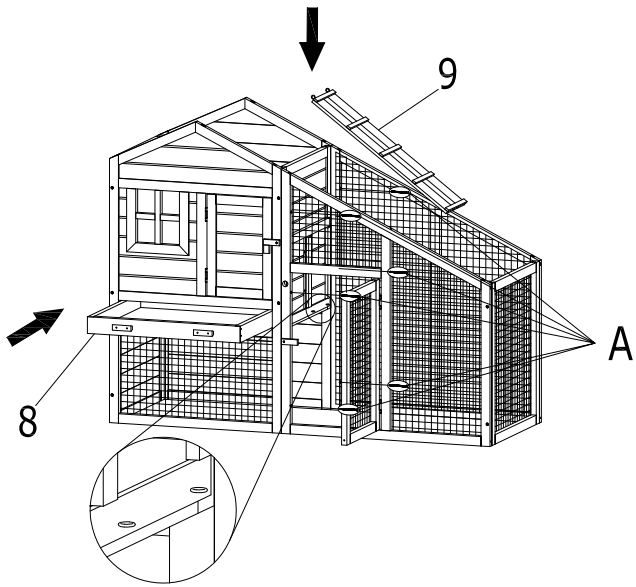

Schritt 4:

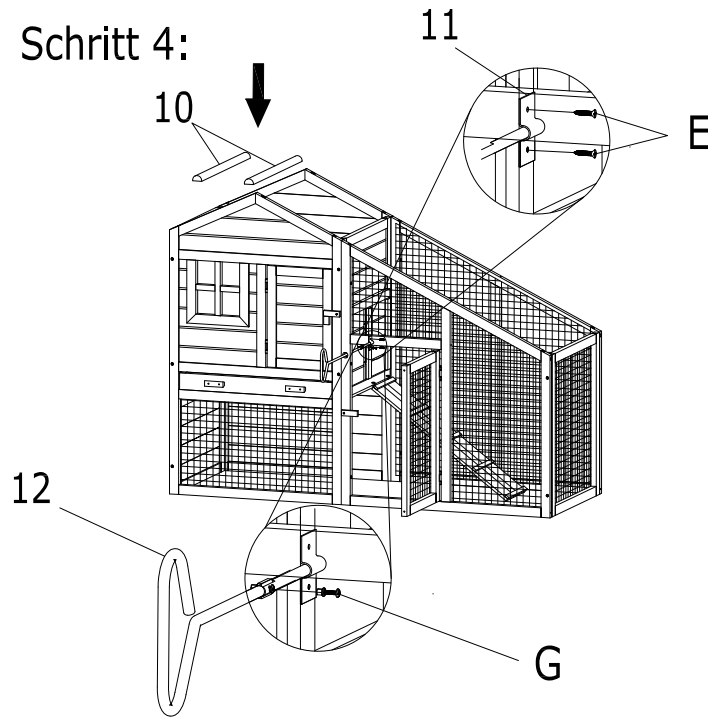

Schritt 5:

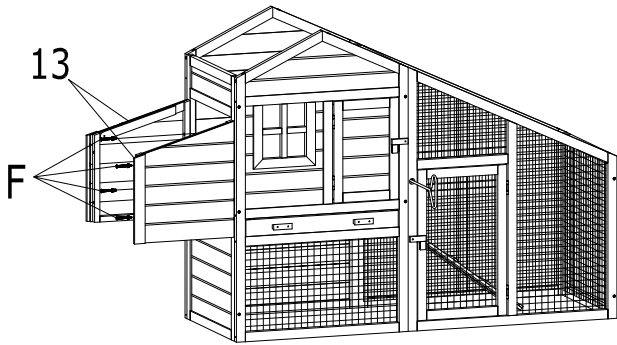

Schritt 6:

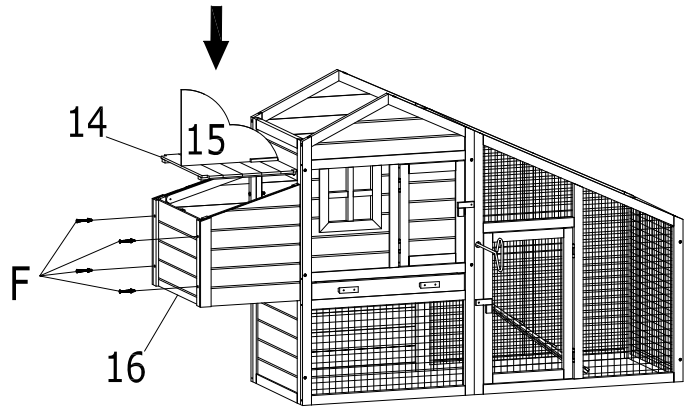

Schritt 7:

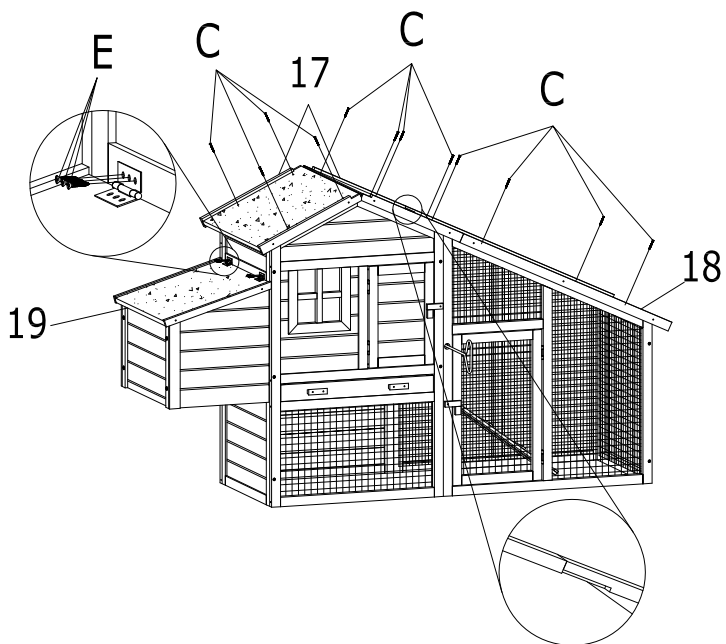

Schritt 8:

