

980565

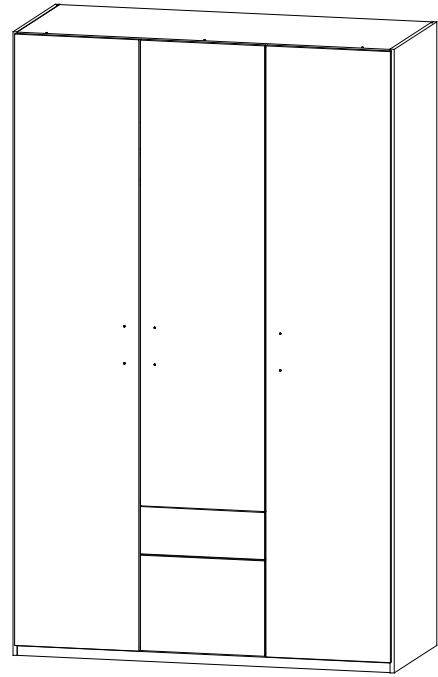

NSP 135

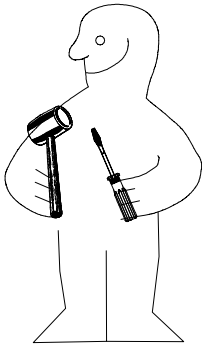

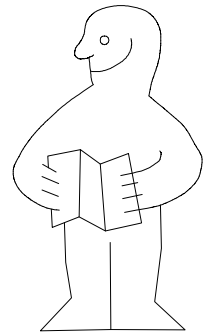
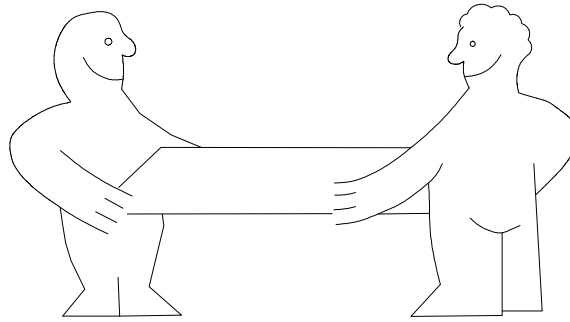
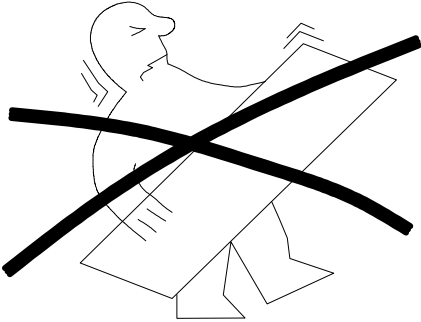

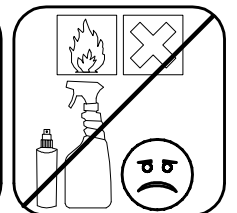
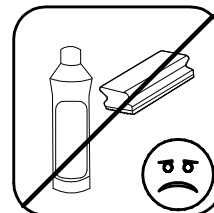
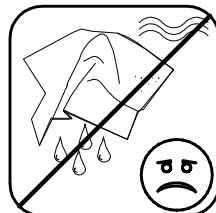
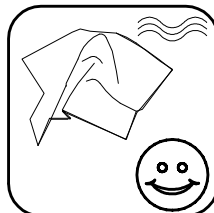
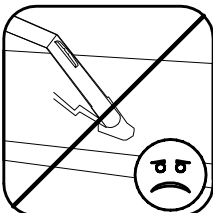
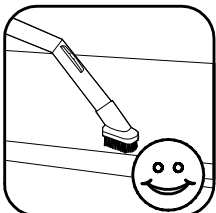
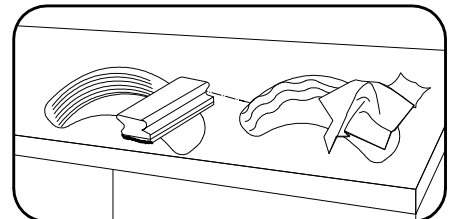
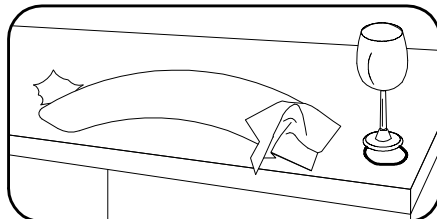
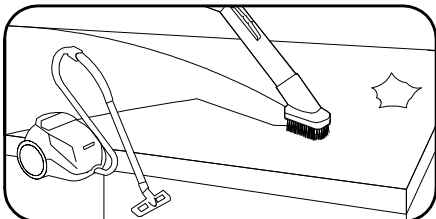
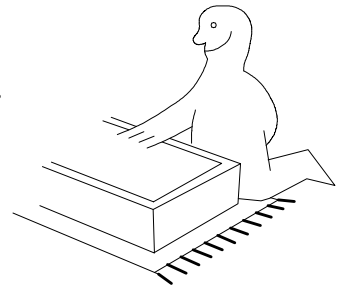
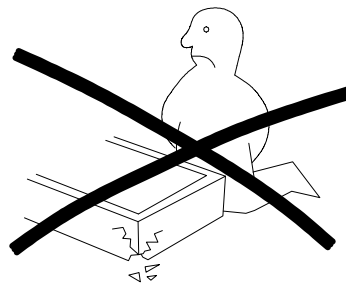
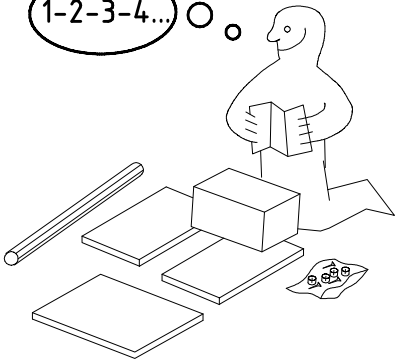

1-2-3-4...







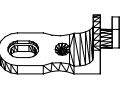

980565

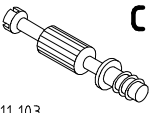
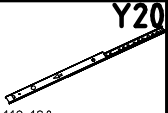

06.04.16 / -

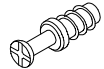
04 16 | 1/11

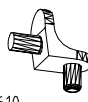
 VB23 111 252	4x
 A 111 102 M4 x 9 mm	14x
 G8 111 015	4x
 K1 117 001	4x
 J1 111 174	4x

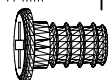
 Z 163 007	1x
 C 111 103	14x
 Y20 112 190	4x
 K21 424mm 112 403	1x
 K20 870mm 112 402	1x

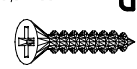
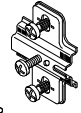
 F 111 229 3,5 x 15 mm	4x
 G1 121 370	8x
 L7 111 610 M6 x 10	8x
 T3 112 616 M6 x 11 mm	8x
 T6 121 181	4x

 3,5 x 35 mm G14 121 375	6x
 M 112 268	9x
 N 112 267	9x

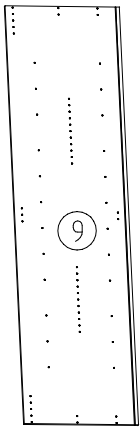
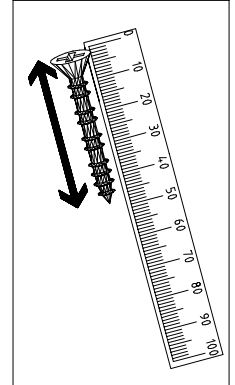
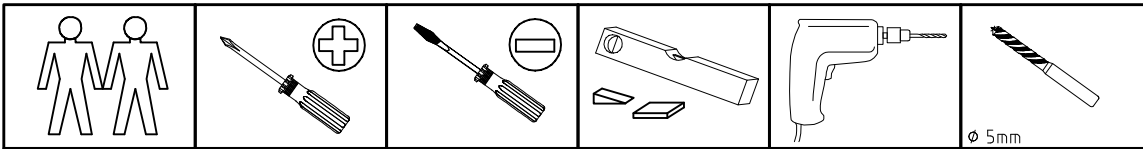
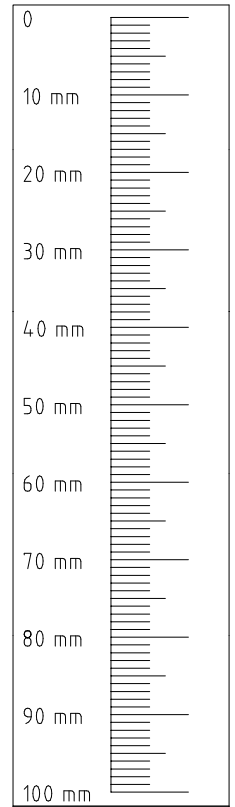

2064x560x15

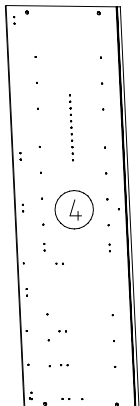

2001x560x15

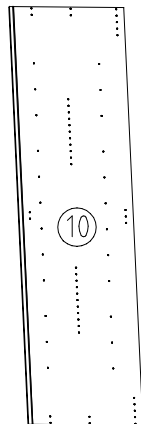

2064x560x15

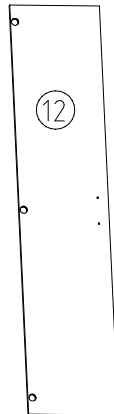

2021x439x15

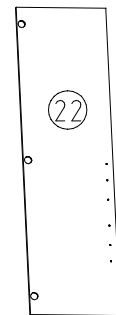

1518x439x15

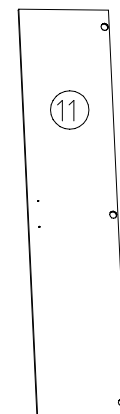

2021x439x15

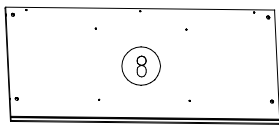

1317x560x15

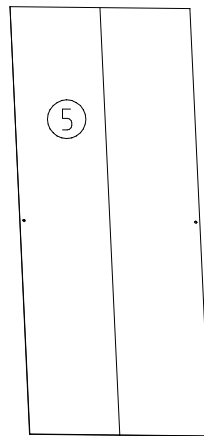

2015x882x2,5

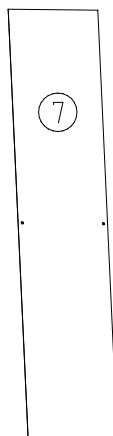

2015x438x2,5

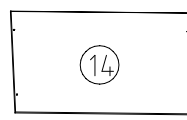

873x500x18

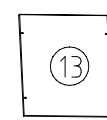

429x500x18

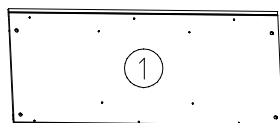

1317x560x15



1317x33x15



1317x33x15

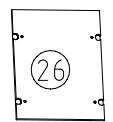

429x540x18

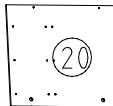

540x500x15



439x330x15

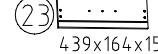

439x164x15

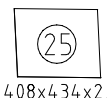

2x 408x434x2,5



439x422x439x200



439x422x439x92

1

2

3,5 x 35 mm G14

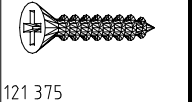

121 375

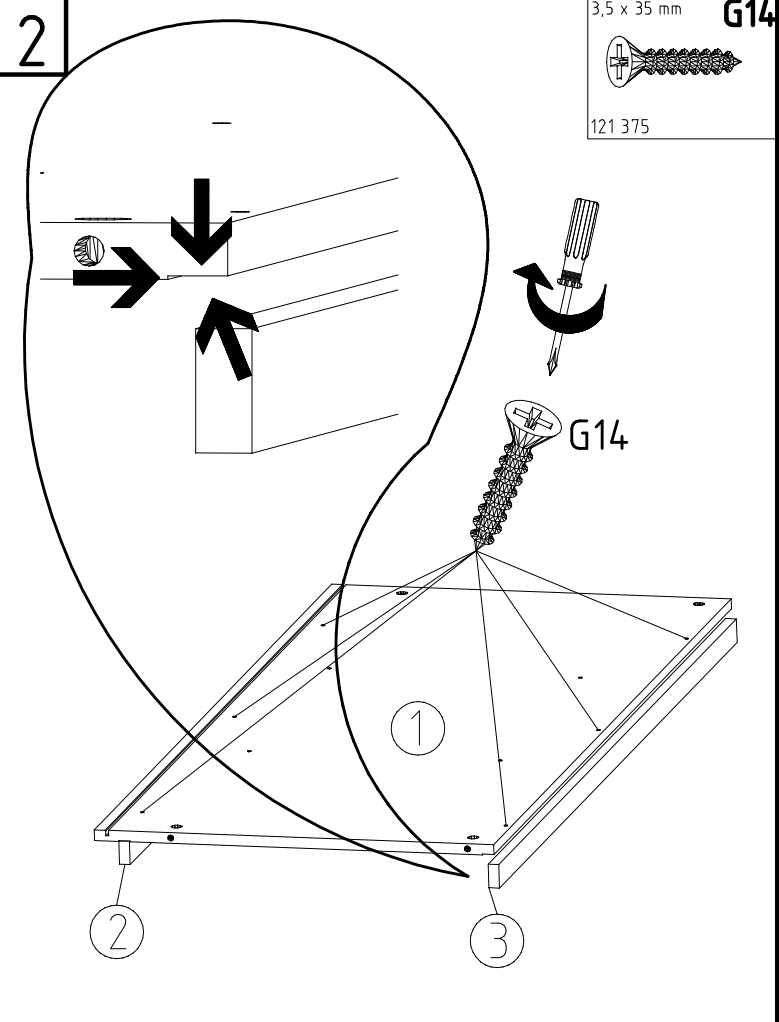
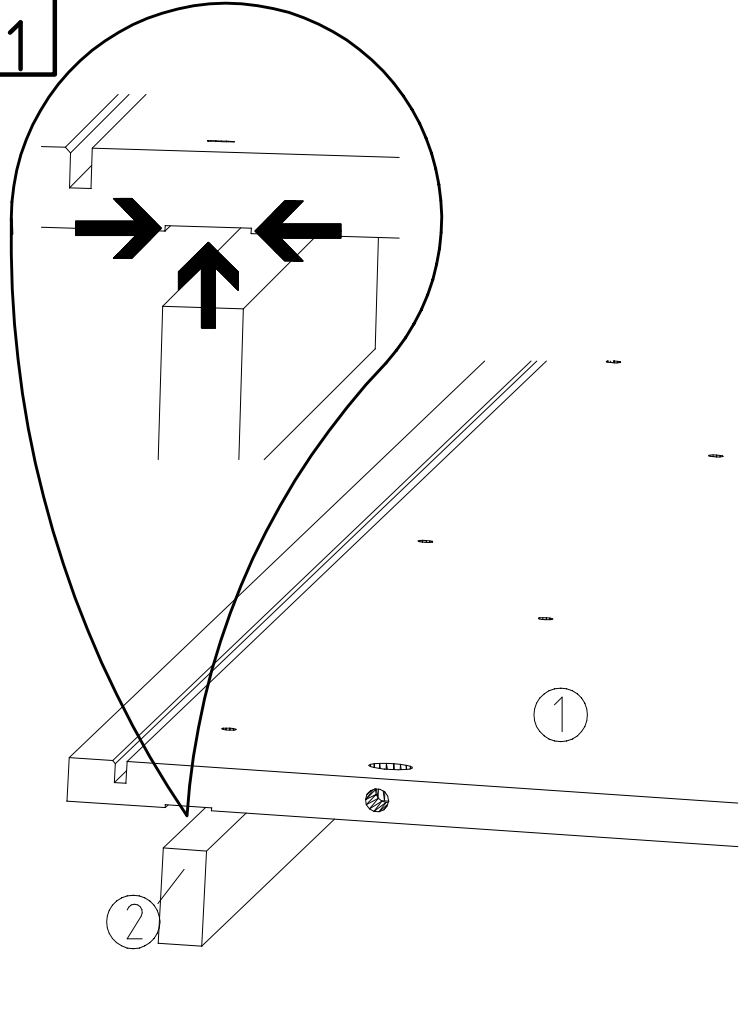

3

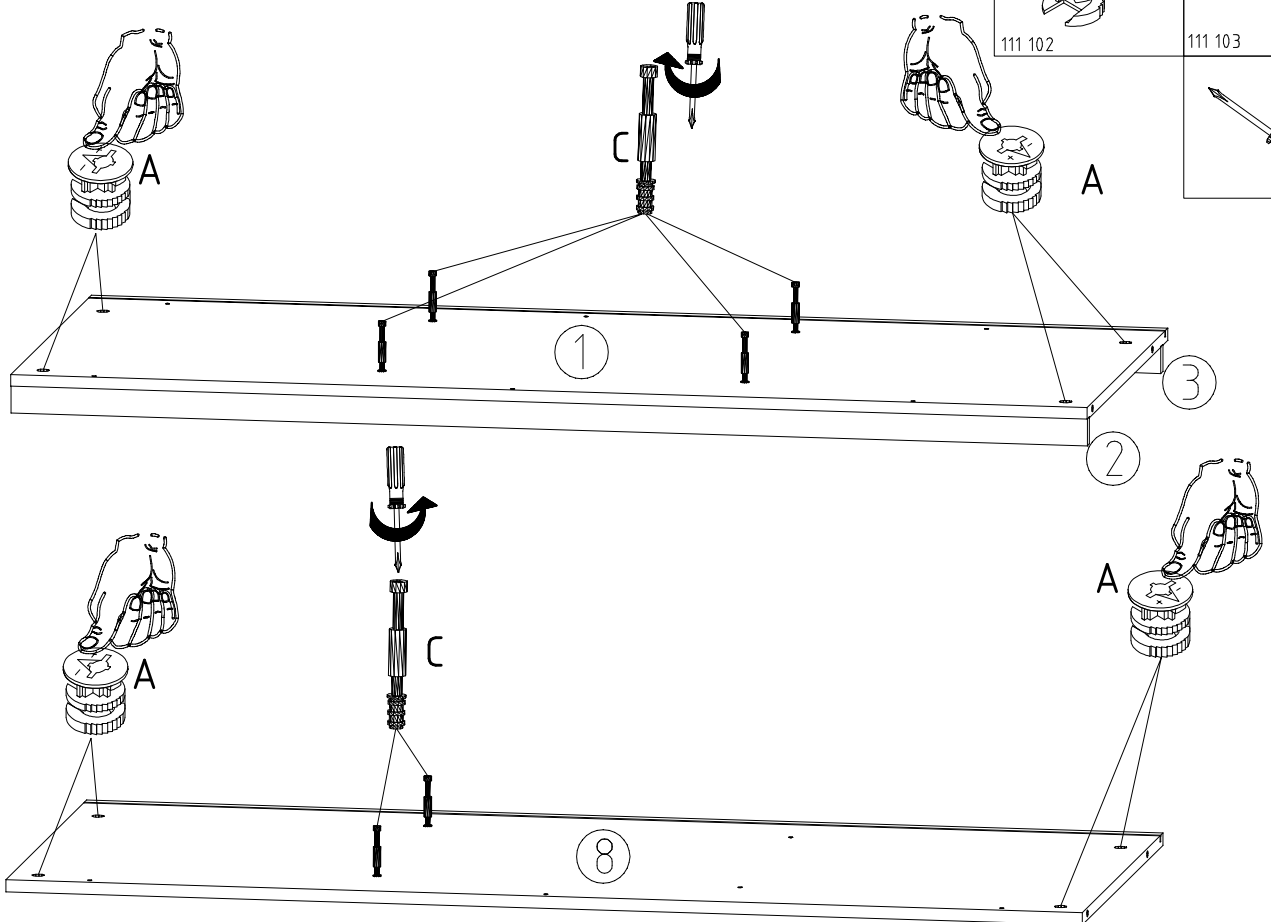
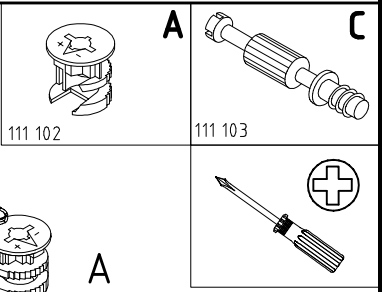
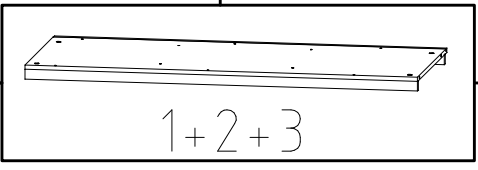

4

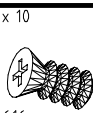
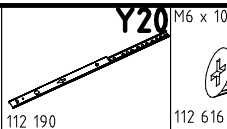
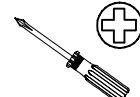

T3

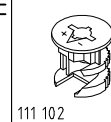
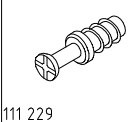

A

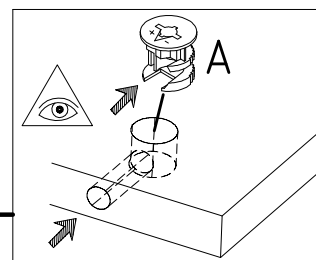
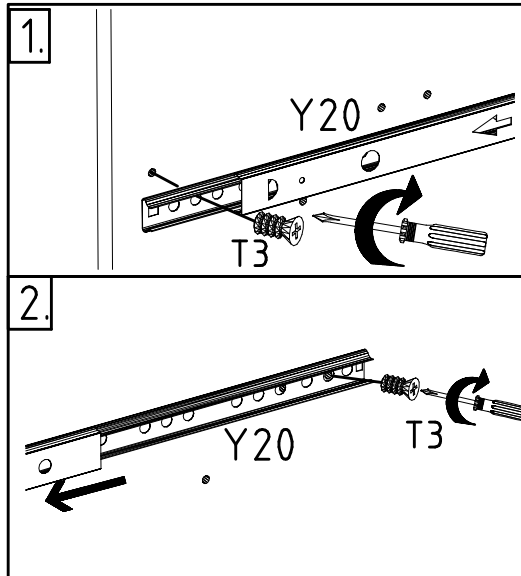
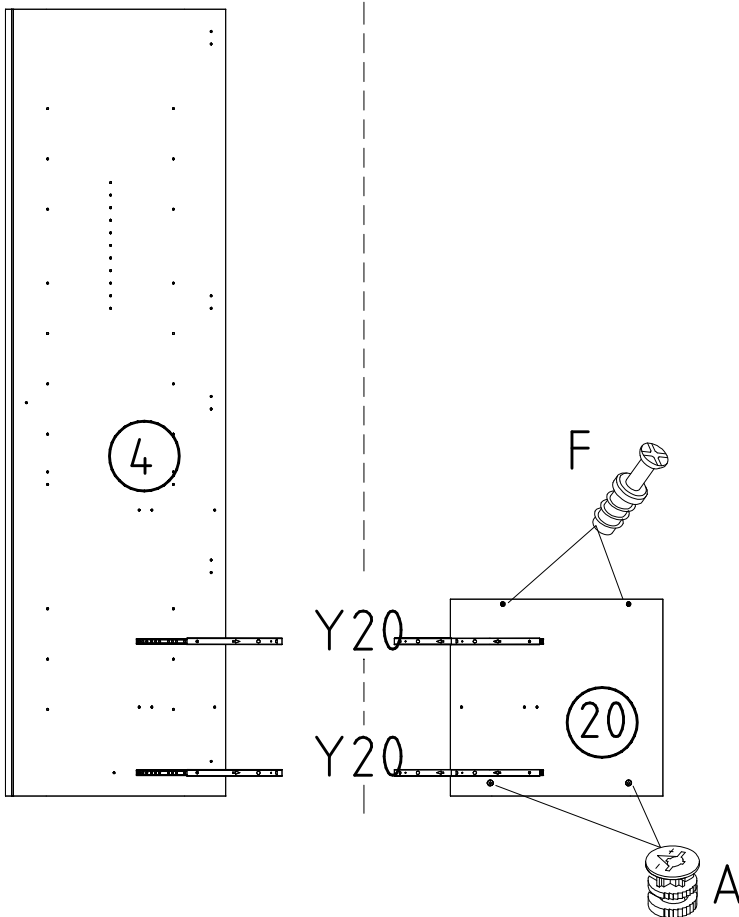

5

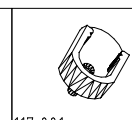
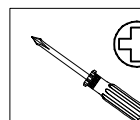
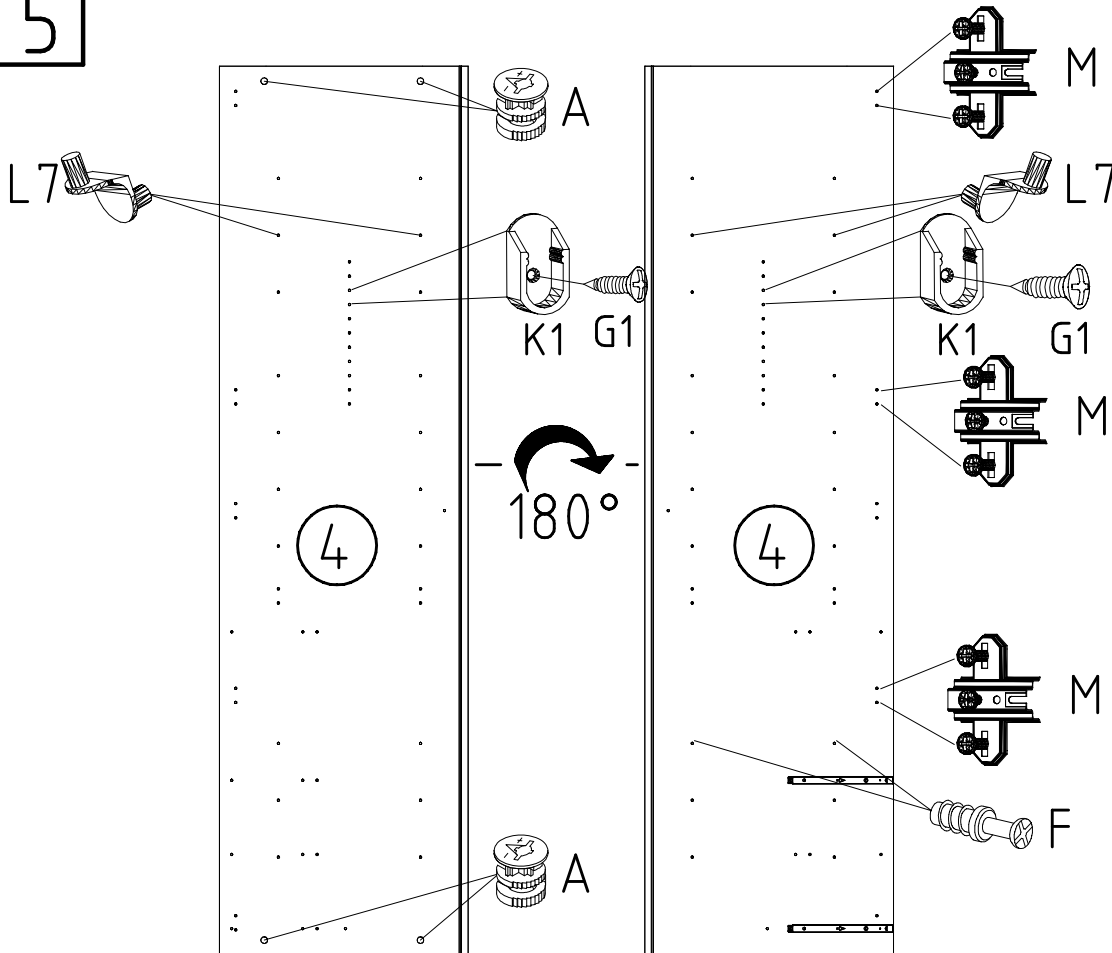

K1

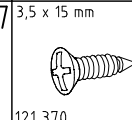
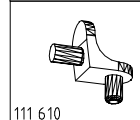

G1

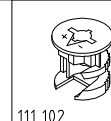

A

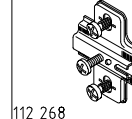

M

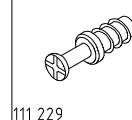



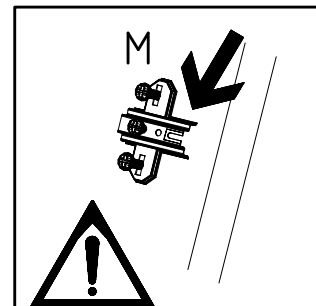

F

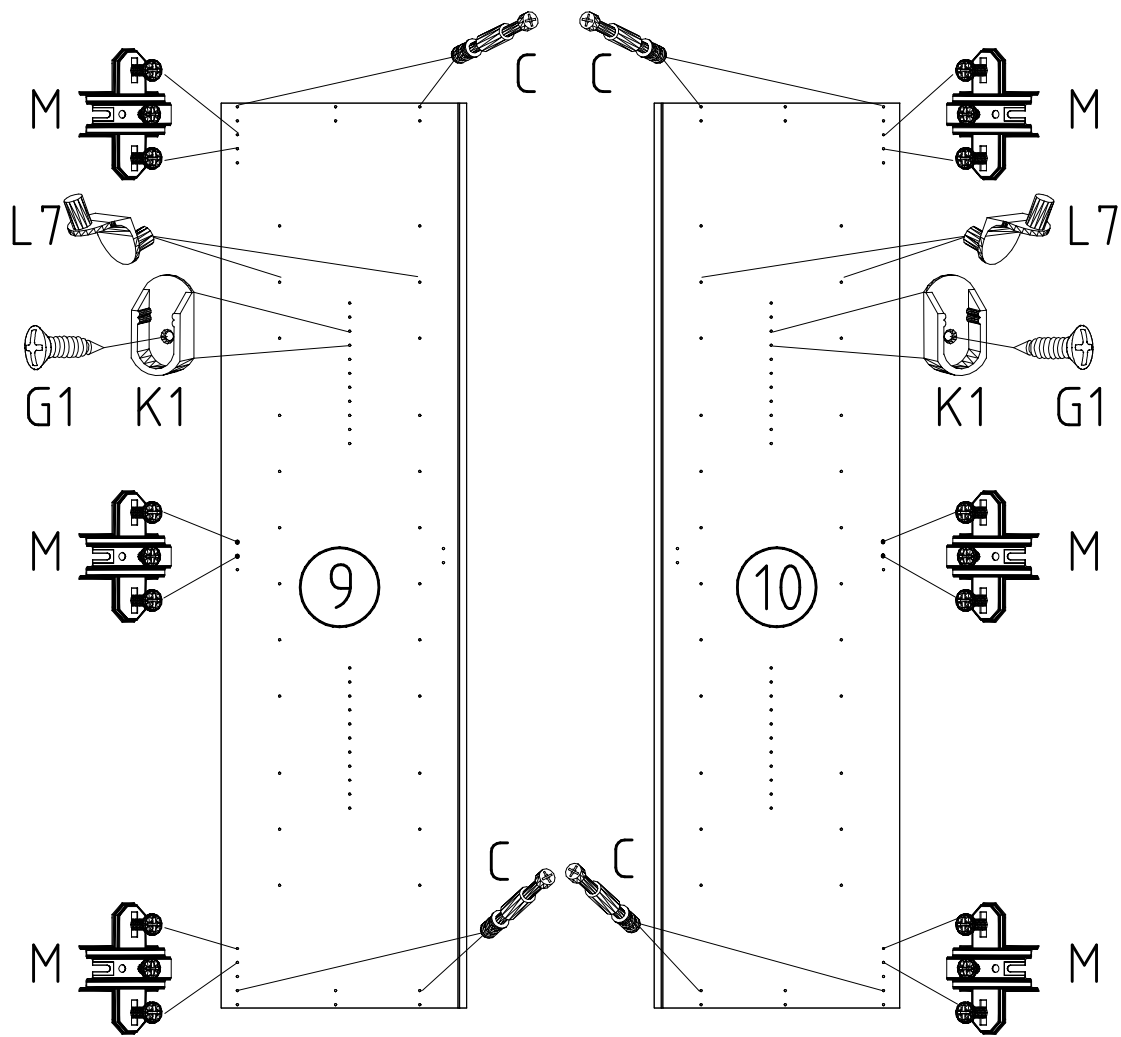

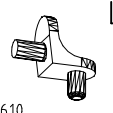
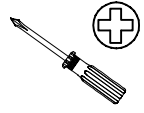
5

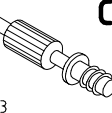
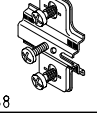

-  L7
111 610
-  
-  K1
117 001
3,5 x 15 mm
-  G1
121 370
-  C
111 103
-  M
112 268

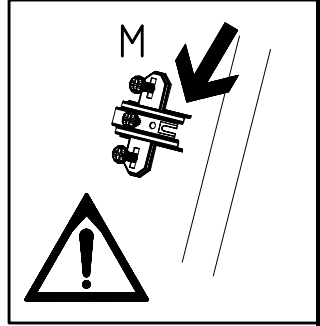

6

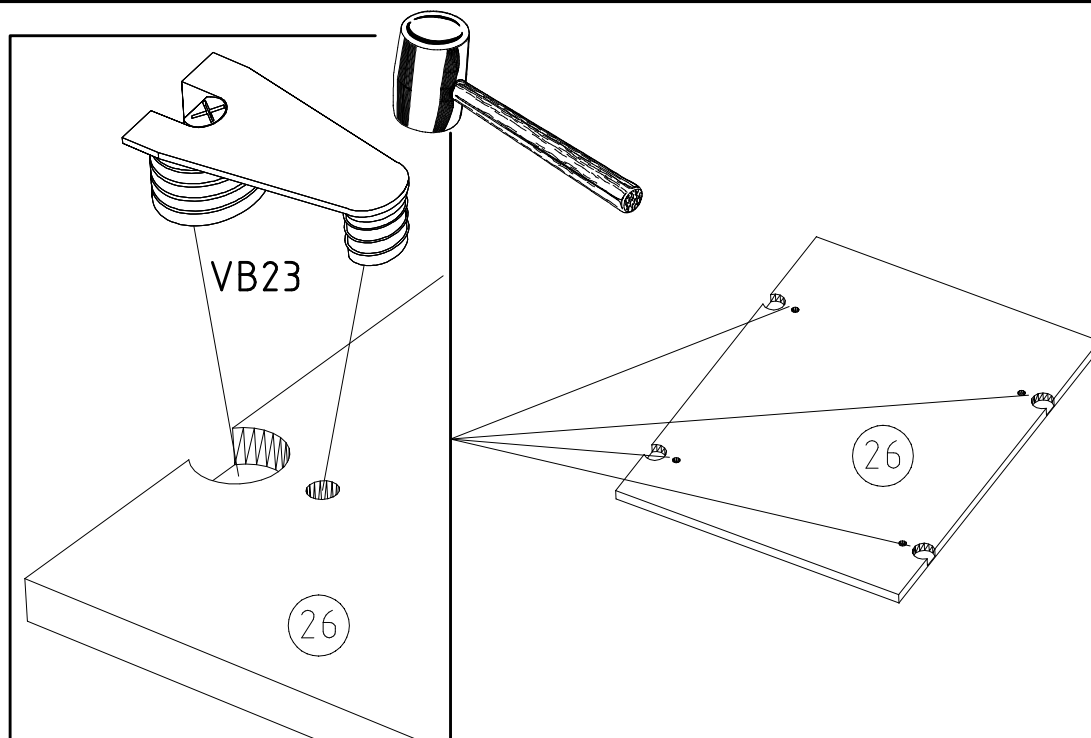

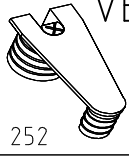
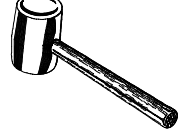
-  VB23
111 252
- 

7

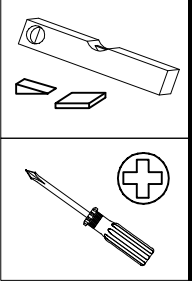
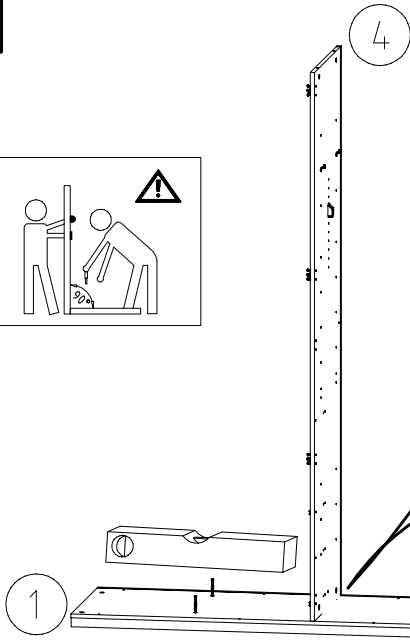
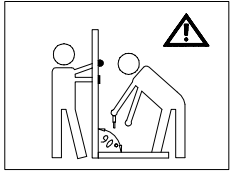

8

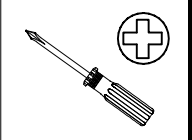
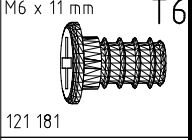
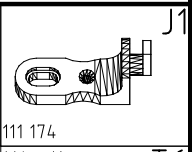
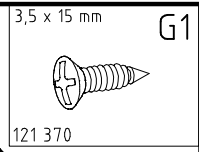
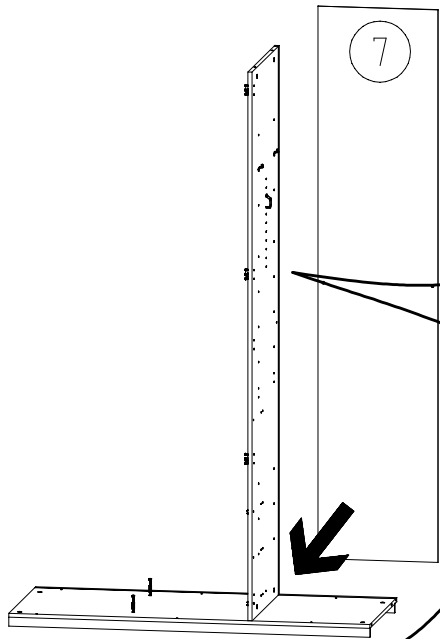

9

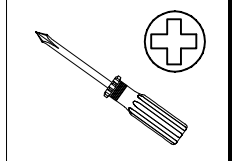
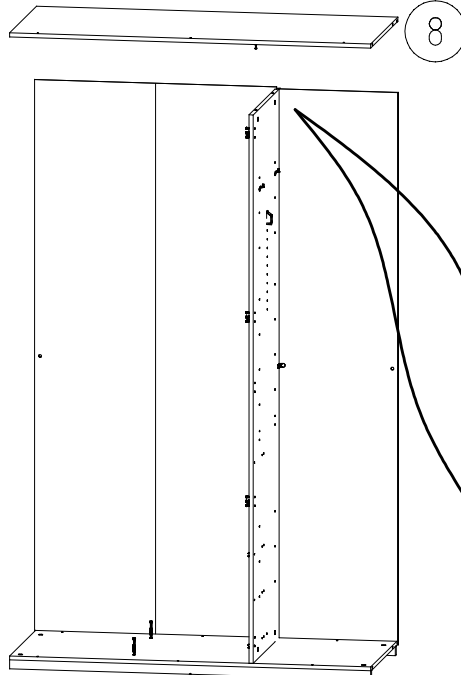
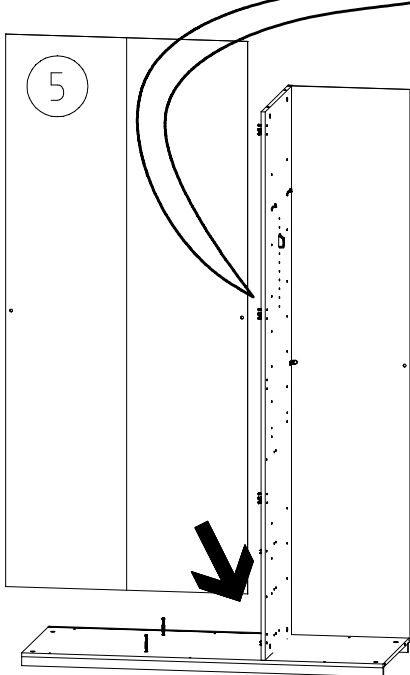

10

9

10

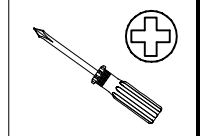
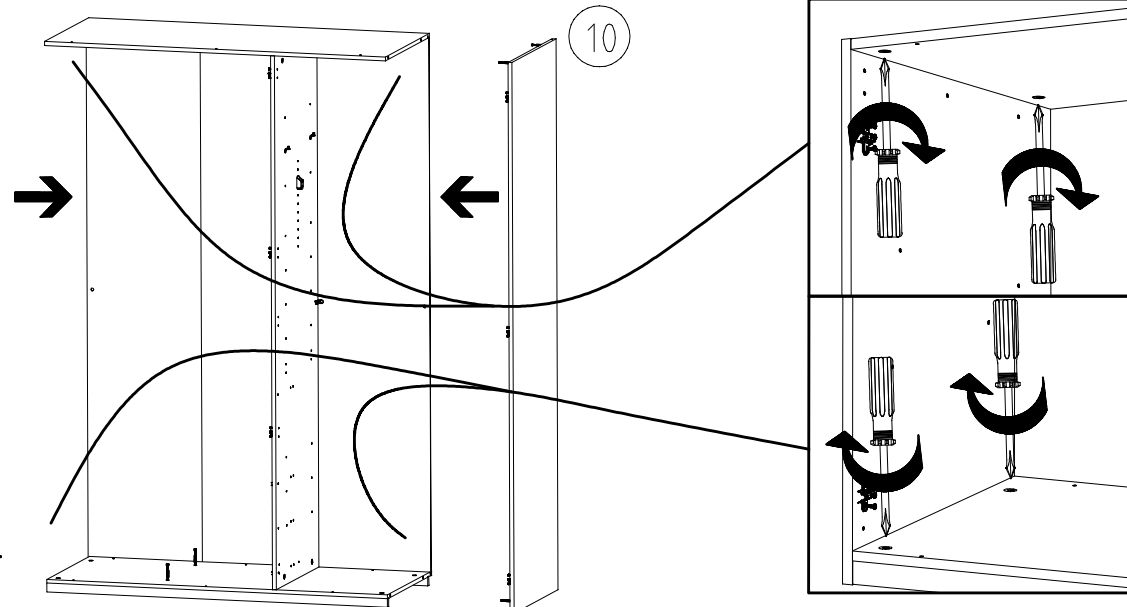

11

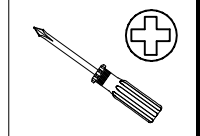
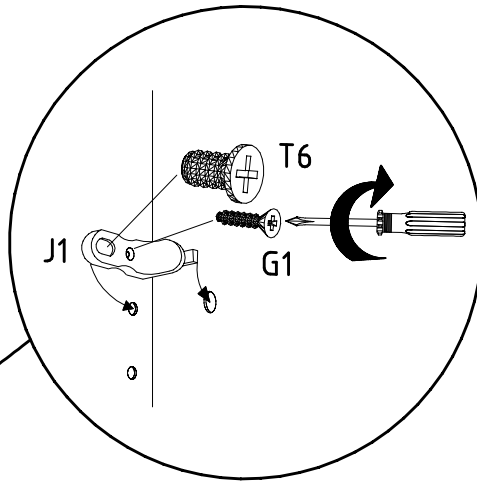
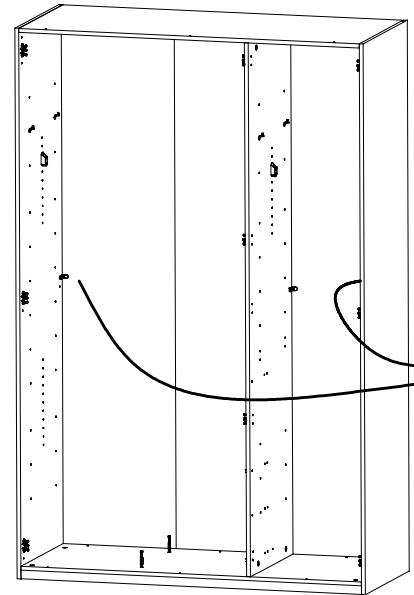

3,5 x 15 mm G1

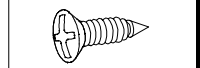

121 370 M6 x 11 mm T6

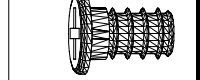

121 181

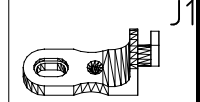

111 174

12

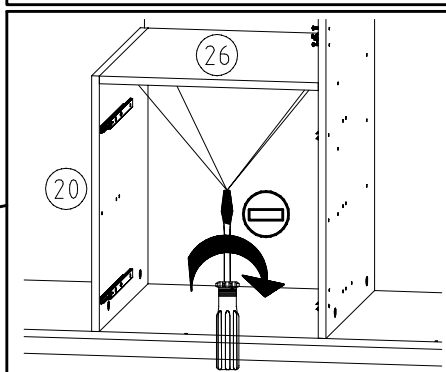
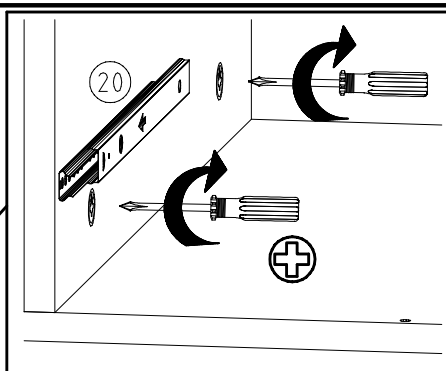
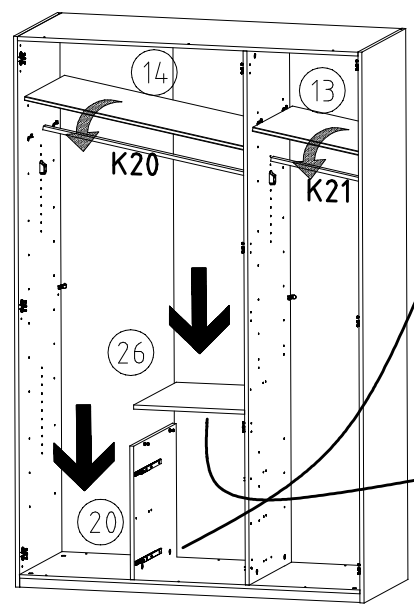

870mm K20



112 402

424mm K21



112 403

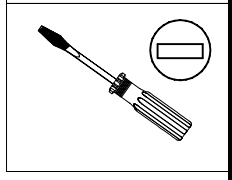
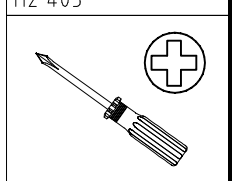

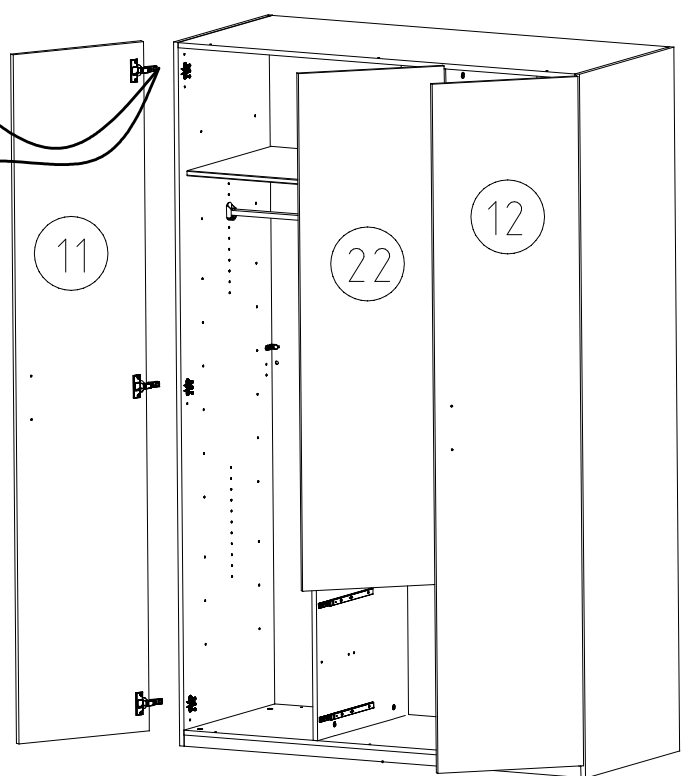
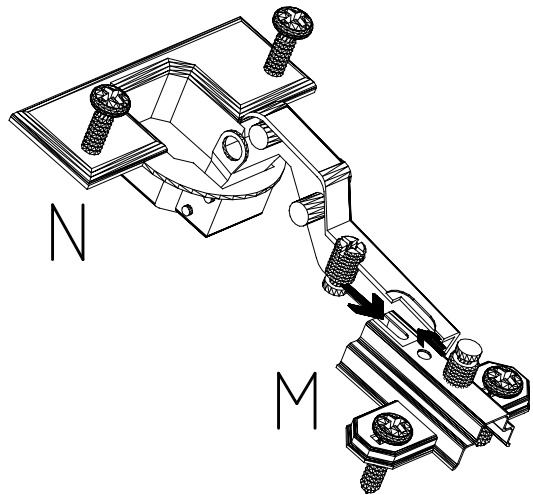
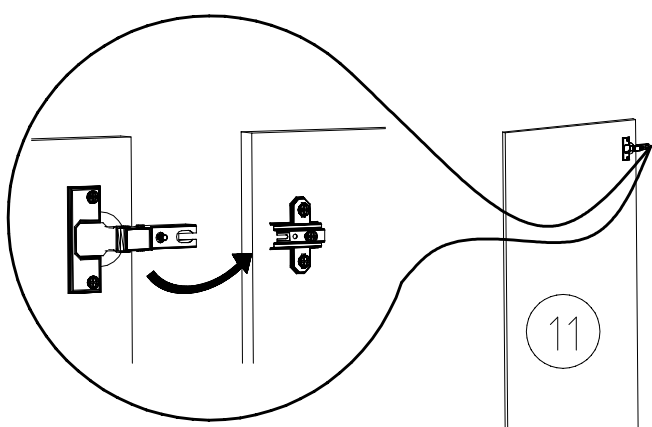
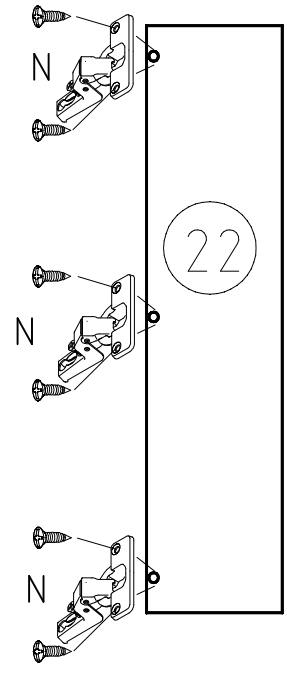
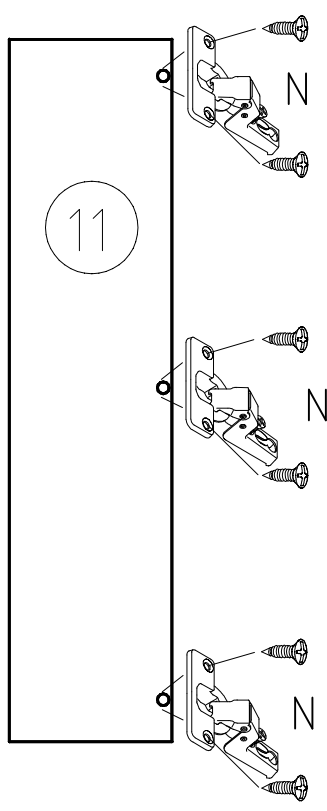
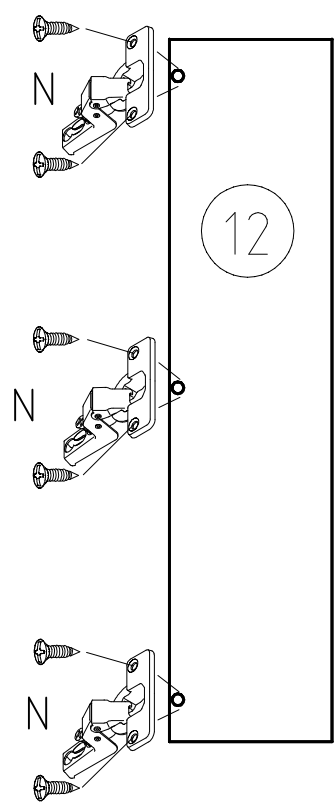
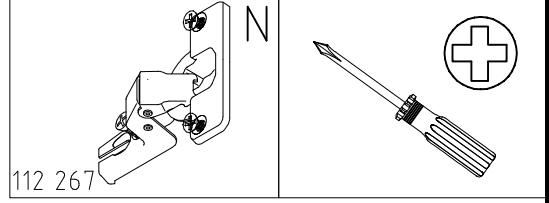
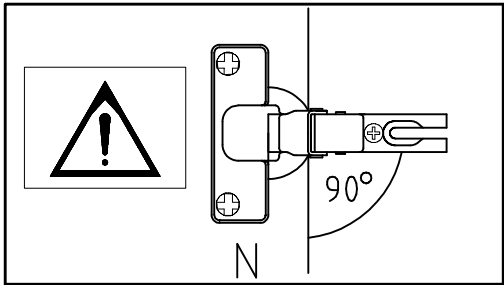

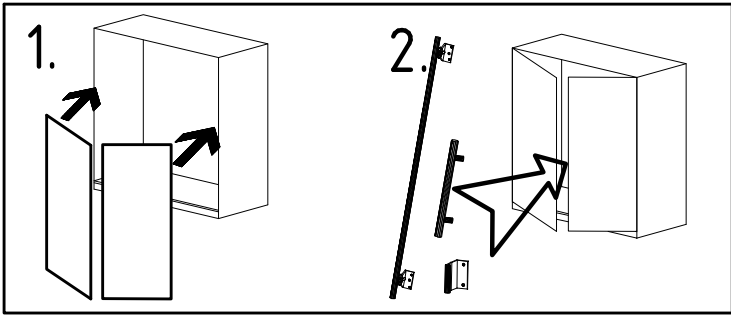
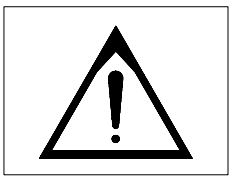

3,5 x 15 mm 121 370	G1	4,0 x 12 mm 122 625	G56
------------------------	----	------------------------	-----

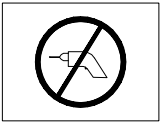
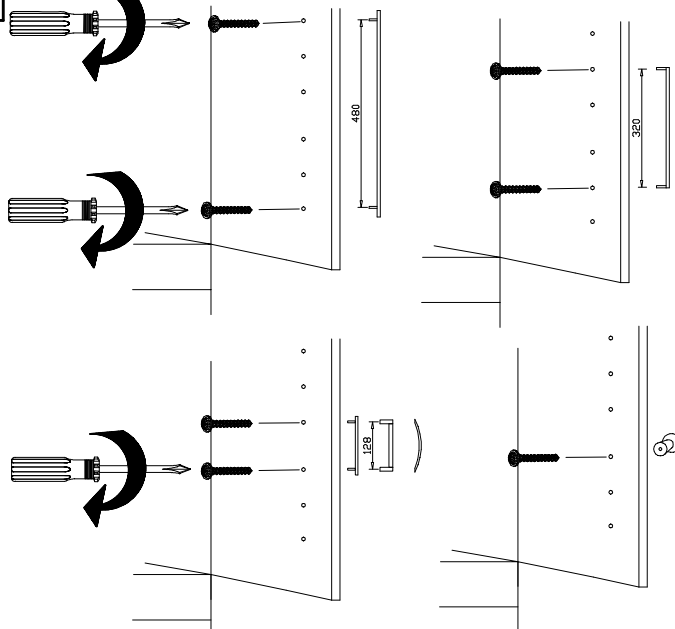
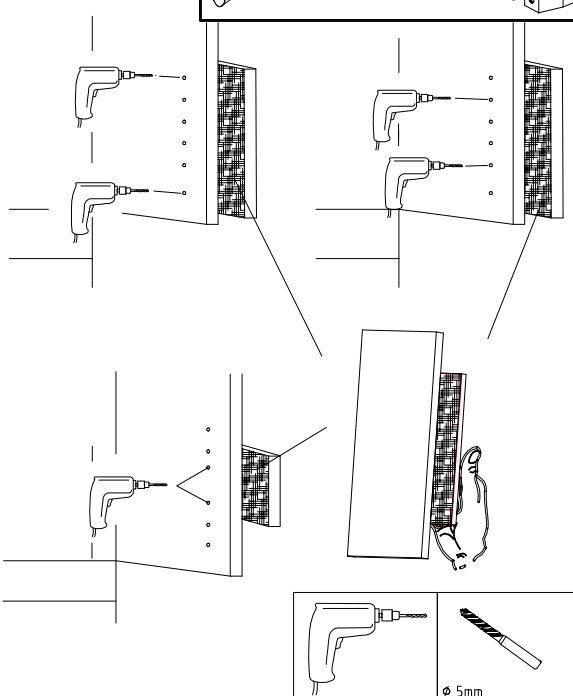
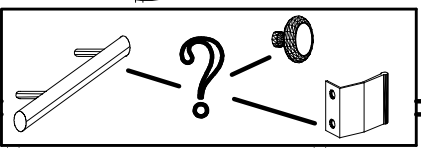
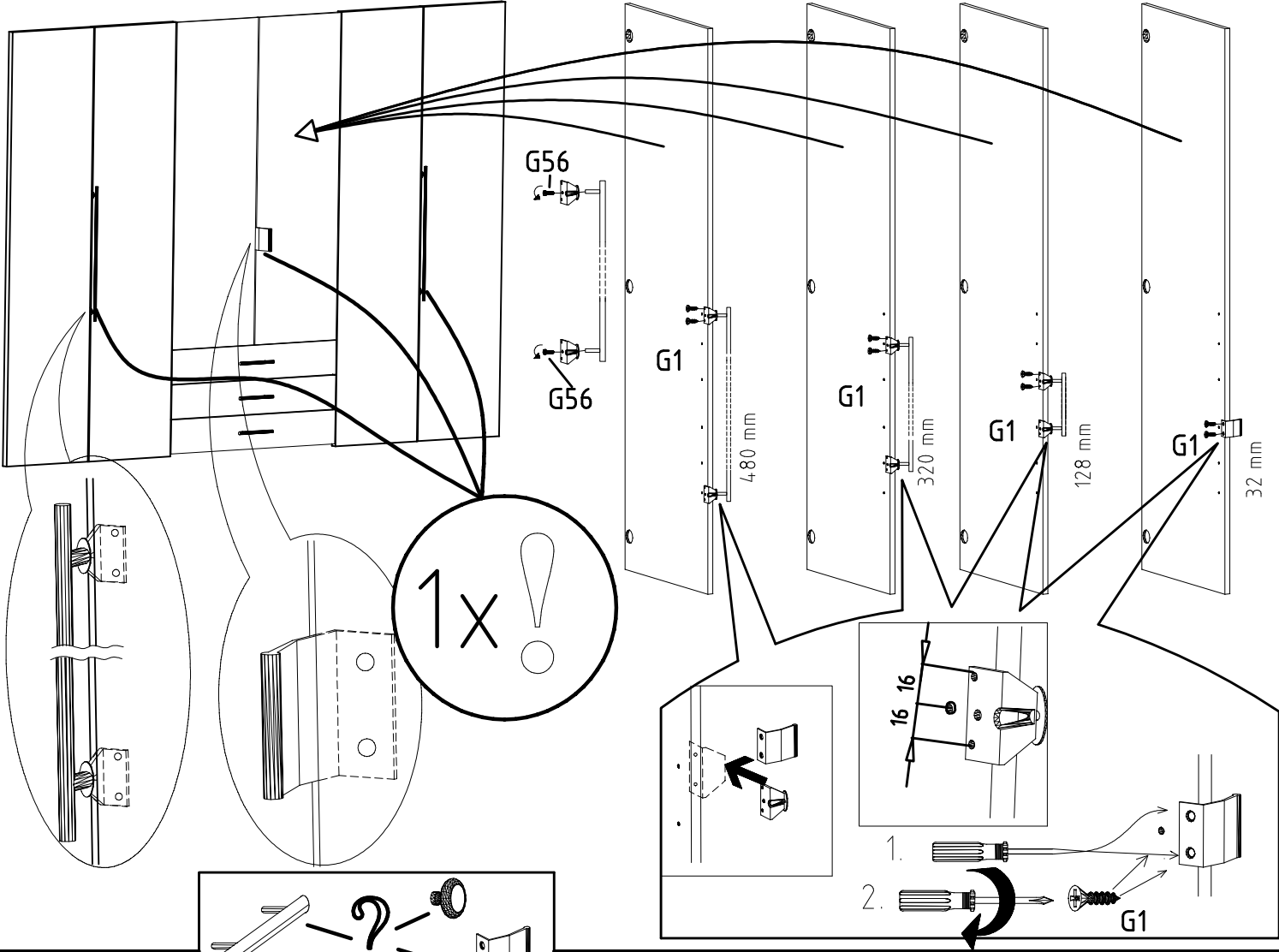

	SP27
4 X 27mm	
122620	
4,0x22	G49
122 609	

15

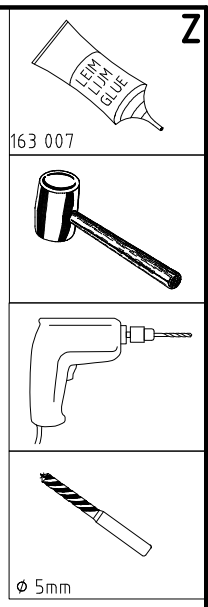
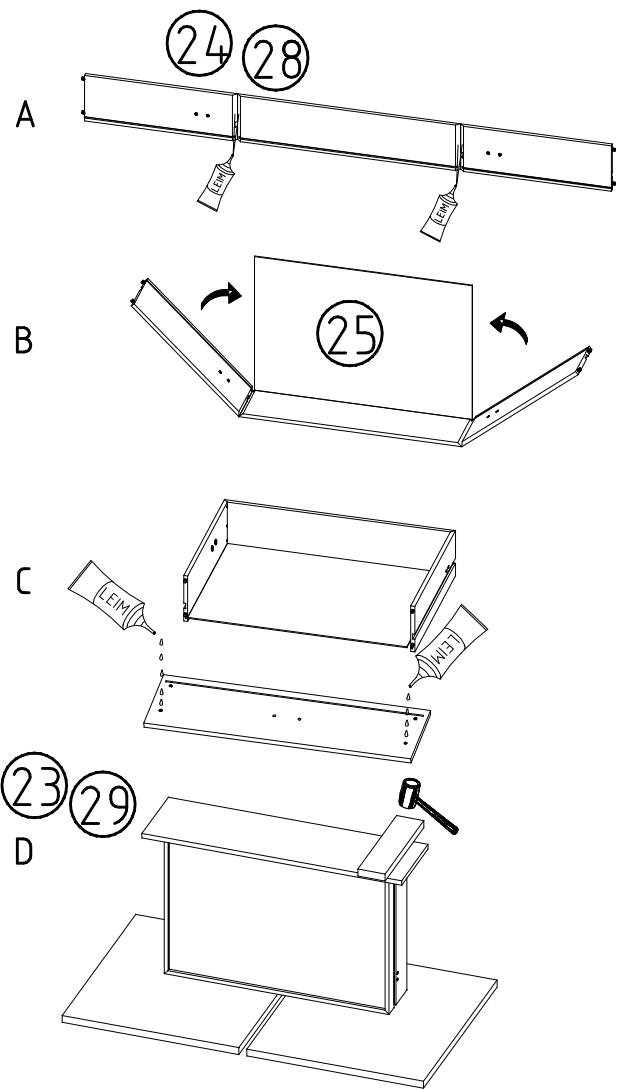
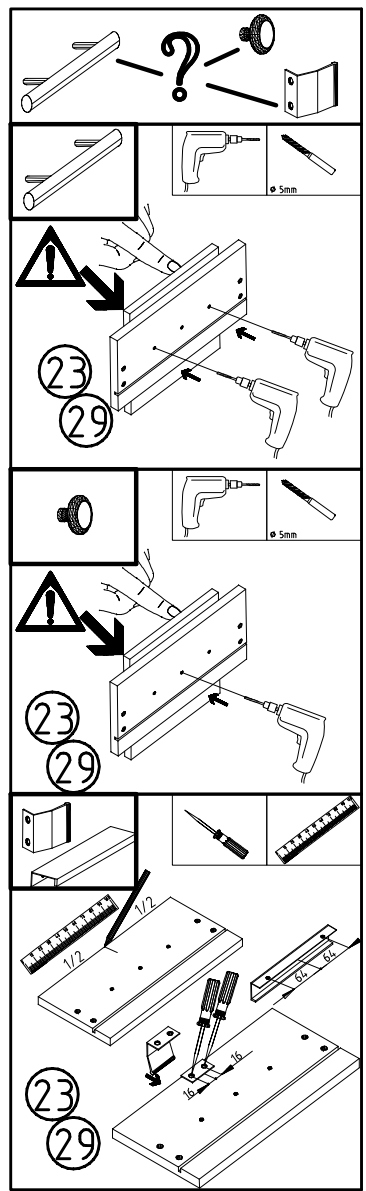

16

