

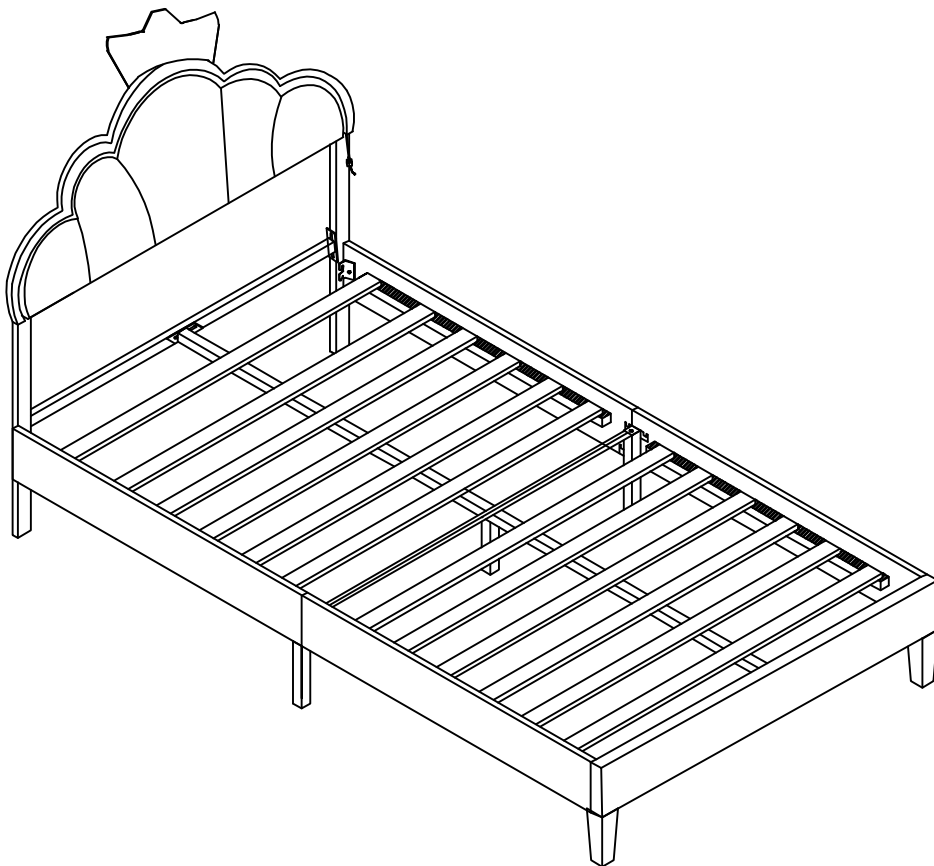



MONTAGEANLEITUNG

WICHTIGER HINWEIS:



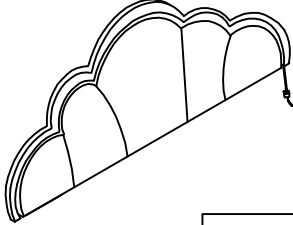
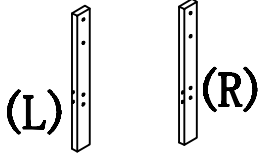
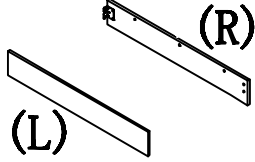
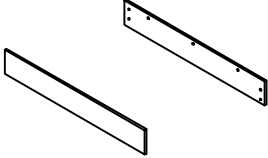
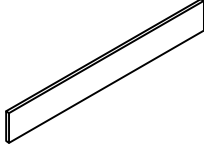
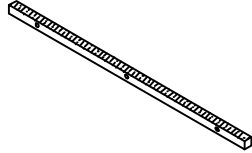

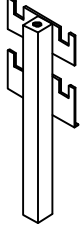

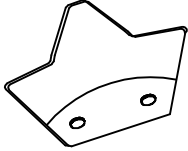
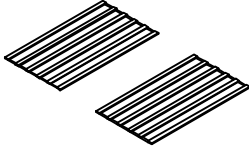
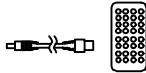
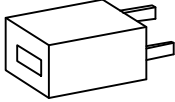
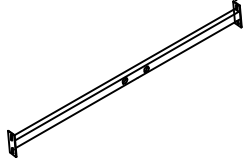
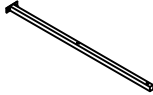
- ※ LEGEN SIE ALLE TEILE AUF EINE SAUBERE UND GLATTE OBERFLÄCHE, Z. B. EINE TEPPICH ODER TEPPICH, UM ZU VERMEIDEN, DASS DIE TEILE ZERKRATZT WERDEN.
- ※ BITTE BEFOLGEN SIE DIE MONTAGEANLEITUNG SCHRITT FÜR SCHRITT.
- ※ ZIEHEN SIE NICHT ALLE SCHRAUBEN AN, BIS DAS BETT VOLLSTÄNDIG EINGERICHTET IST.

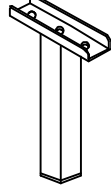
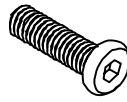
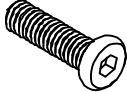
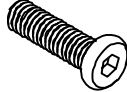
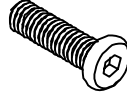
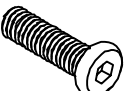

Assembly Steps(EN)

| | | |
|--|---|--|
| <p>① Headboard</p>  <p>1PC</p> | <p>② HB Leg</p>  <p>2PCS</p> | <p>③ Side Rail A</p>  <p>2PCS</p> |
| <p>④ Side Rail B</p>  <p>2PCS</p> | <p>⑤ Footboard</p>  <p>1PC</p> | <p>⑥ Side Rail Support</p>  <p>4PCS</p> |
| <p>⑦ Centre Connector</p>  <p>1PC</p> | <p>⑧ Side Rail Feet</p>  <p>2PCS</p> | <p>⑨ FB Leg</p>  <p>2PCS</p> |
| <p>⑩</p>  <p>1PC</p> | <p>⑪ Slat</p>  <p>2Set</p> | <p>⑫</p>  <p>1PC</p> |
| <p>⑬</p>  | <p>⑭ HB Support Rail</p>  <p>1PC</p> | <p>⑮ Centre Support Rail</p>  <p>2PCS</p> |

Assembly Steps(EN)

| | | |
|--|--|---|
| <p>⑩ Support Leg</p>  <div style="text-align: right; border: 1px solid black; padding: 2px; width: fit-content; margin-left: auto;">2PCS</div> | <p>⑰ Centre Support Leg</p>  <div style="text-align: right; border: 1px solid black; padding: 2px; width: fit-content; margin-left: auto;">1PC</div> | <p>①</p>  <div style="text-align: right; border: 1px solid black; padding: 2px; width: fit-content; margin-left: auto;">5/16"×20mm 8+1 PCS</div> |
| <p>②</p>  <div style="text-align: right; border: 1px solid black; padding: 2px; width: fit-content; margin-left: auto;">5\16"*25MM 14+1 PCS</div> | <p>③</p>  <div style="text-align: right; border: 1px solid black; padding: 2px; width: fit-content; margin-left: auto;">5\16"*55MM 9+1 PCS</div> | <p>④</p>  <div style="text-align: right; border: 1px solid black; padding: 2px; width: fit-content; margin-left: auto;">1\4"*15MM 8+1 PCS</div> |
| <p>⑤</p>  <div style="text-align: right; border: 1px solid black; padding: 2px; width: fit-content; margin-left: auto;">1\4"*38MM 14+1 PCS</div> | <p>⑥</p>  <div style="text-align: right; border: 1px solid black; padding: 2px; width: fit-content; margin-left: auto;">5/16"×19mm 31+3 PCS</div> | <p>⑦</p>  <div style="text-align: right; border: 1px solid black; padding: 2px; width: fit-content; margin-left: auto;">1/4" ×16mm 22+2 PCS</div> |
| <p>⑧</p>  <div style="text-align: right; border: 1px solid black; padding: 2px; width: fit-content; margin-left: auto;">5/16" 31+3 PCS</div> | <p>⑨</p>  <div style="text-align: right; border: 1px solid black; padding: 2px; width: fit-content; margin-left: auto;">5/16" 1 PCS</div> | <p>⑩</p>  <div style="text-align: right; border: 1px solid black; padding: 2px; width: fit-content; margin-left: auto;">1/4" 1 PCS</div> |

Assembly Steps(EN)

STEP 1

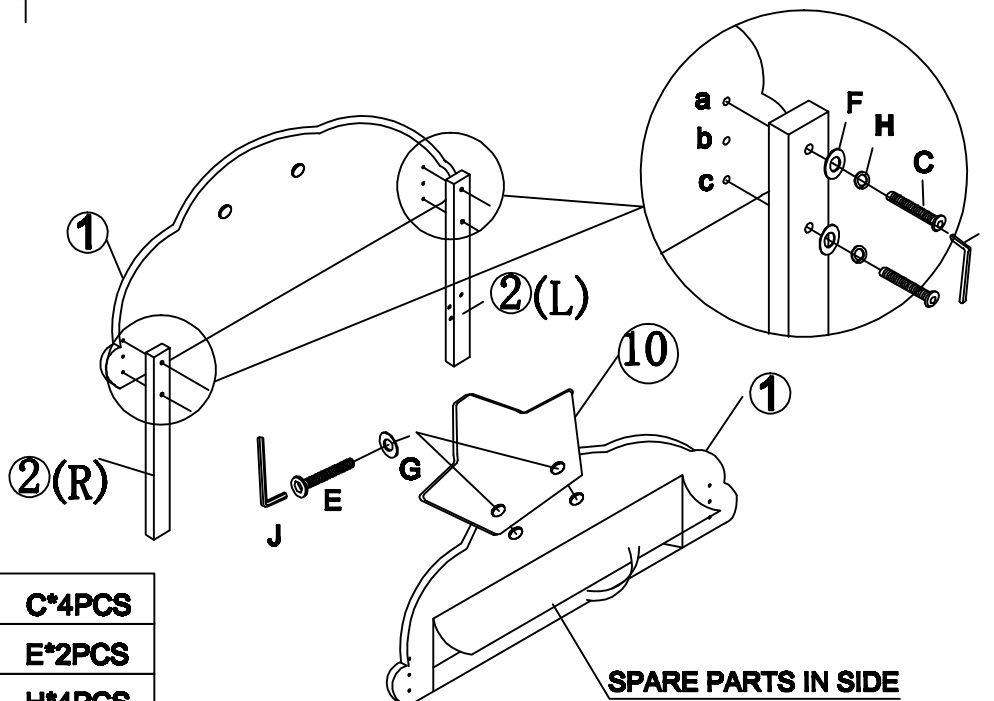

| | |
|--|---------------|
| | C*4PCS |
| | E*2PCS |
| | H*4PCS |
| | F*4PCS |
| | I*1PCS |
| | J*1PCS |

STEP 2

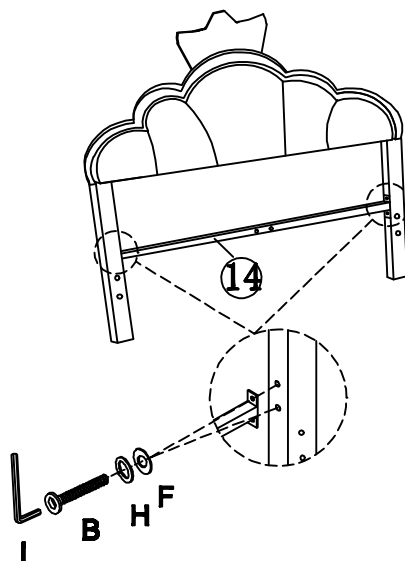



| | |
|--|---------------|
| | B*4PCS |
| | H*4PCS |
| | F*4PCS |
| | I*1PCS |

Assembly Steps(EN)

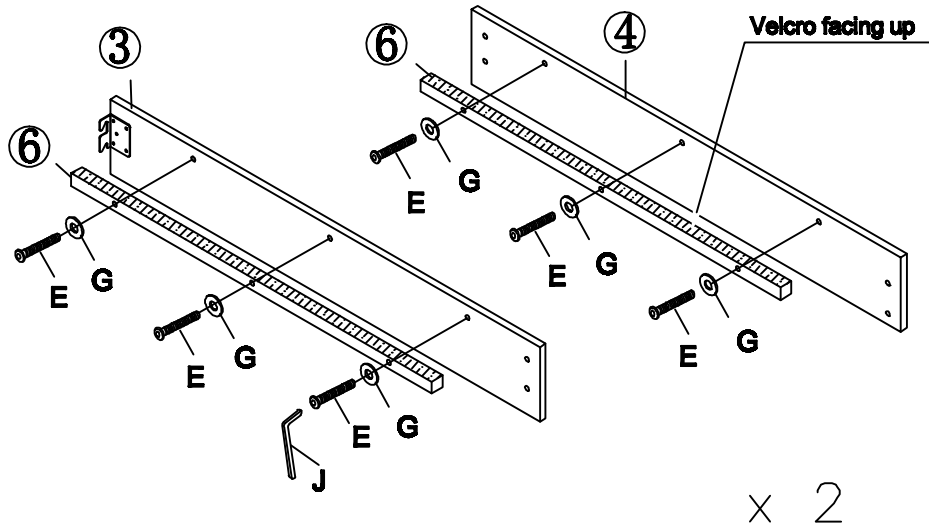

STEP 3

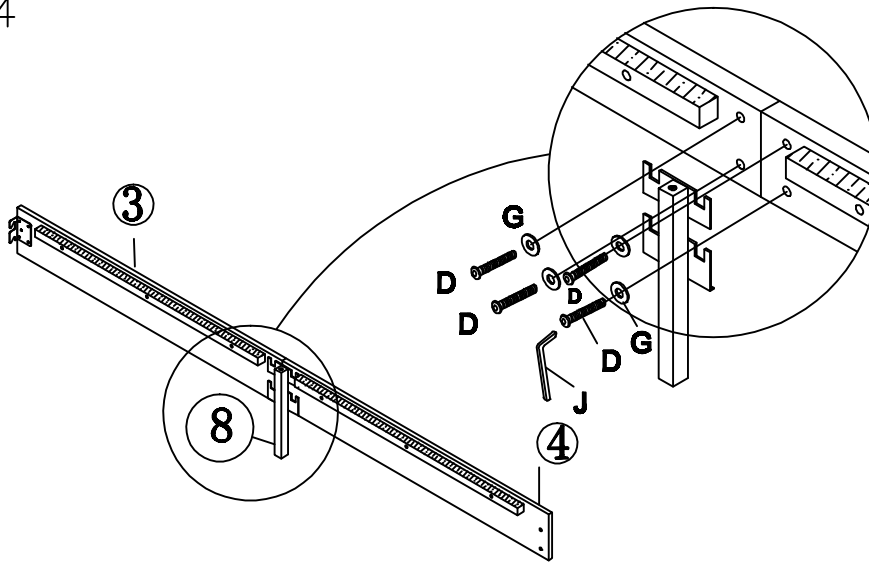

| | |
|---|---------------|
|  | E*6PCS |
|  | G*6PCS |
|  | J*1PCS |

STEP 4





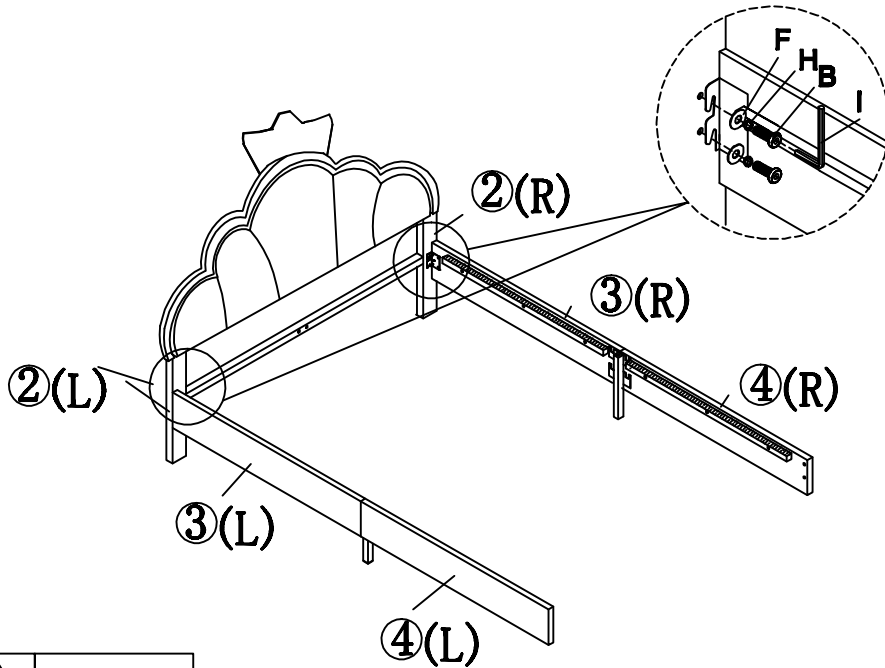

| | |
|---|---------------|
|  | D*8PCS |
|  | G*8PCS |
|  | J*1PCS |

Assembly Steps(EN)





STEP 5

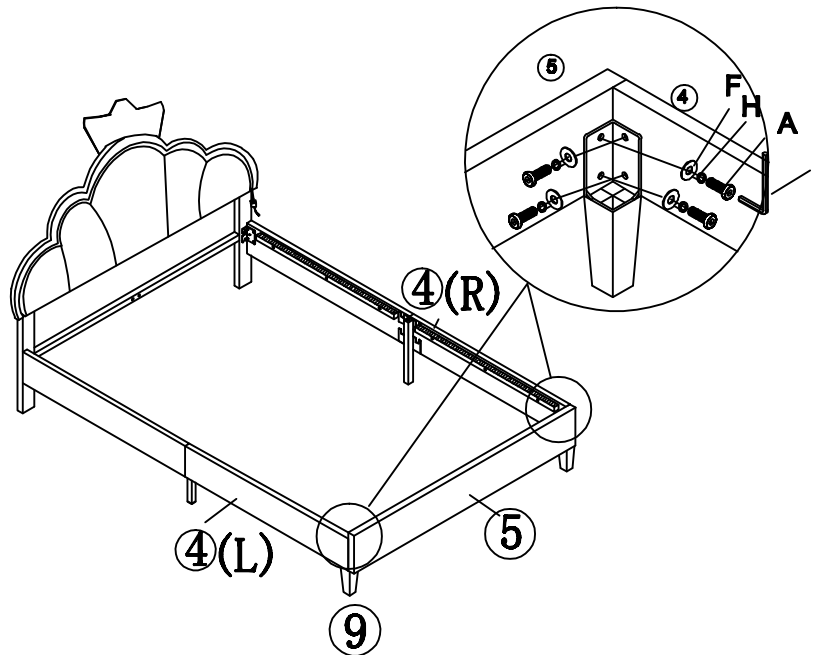

| | |
|---|---------------|
|  | B*4PCS |
|  | H*4PCS |
|  | F*4PCS |
|  | I*1PCS |

STEP 6





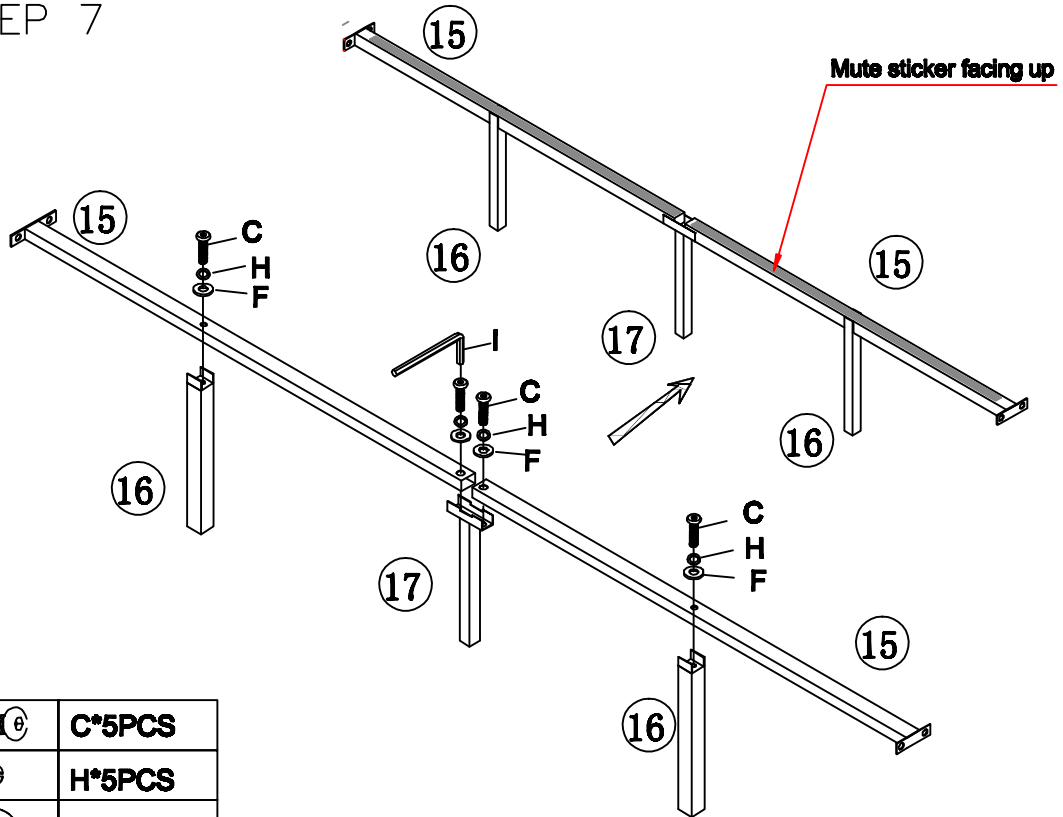

| | |
|---|---------------|
|  | A*4PCS |
|  | H*4PCS |
|  | F*4PCS |
|  | I*1PCS |

Assembly Steps(EN)





STEP 7

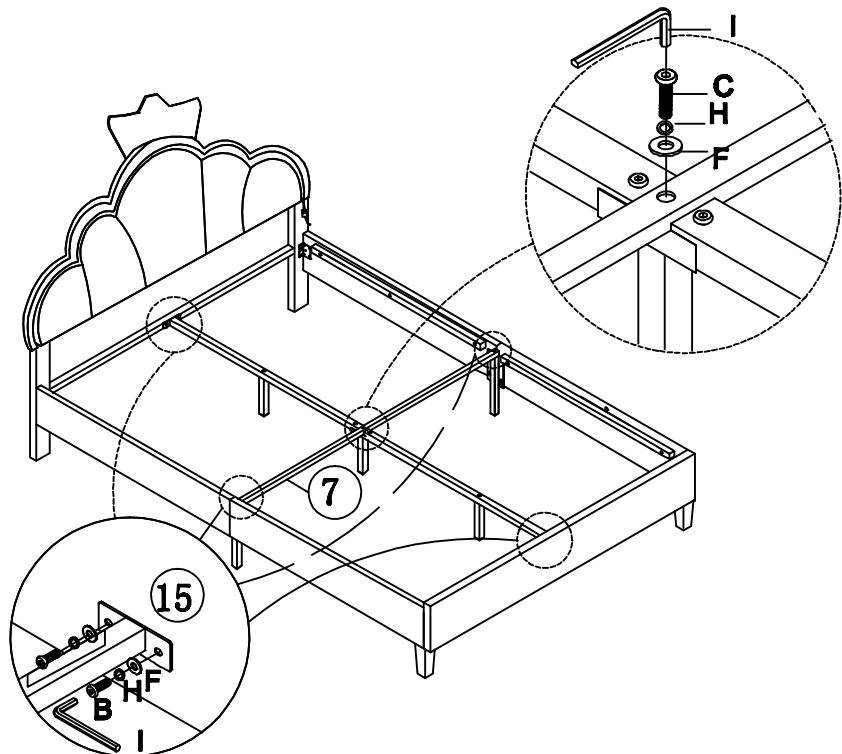

| | |
|---|---------------|
|  | C*5PCS |
|  | H*5PCS |
|  | F*FPCS |
|  | I*1PCS |

STEP 8



| | |
|---|---------------|
|  | C*1PCS |
|  | B*6PCS |
|  | H*8PCS |
|  | F*8PCS |
|  | I*1CS |

STEP 9

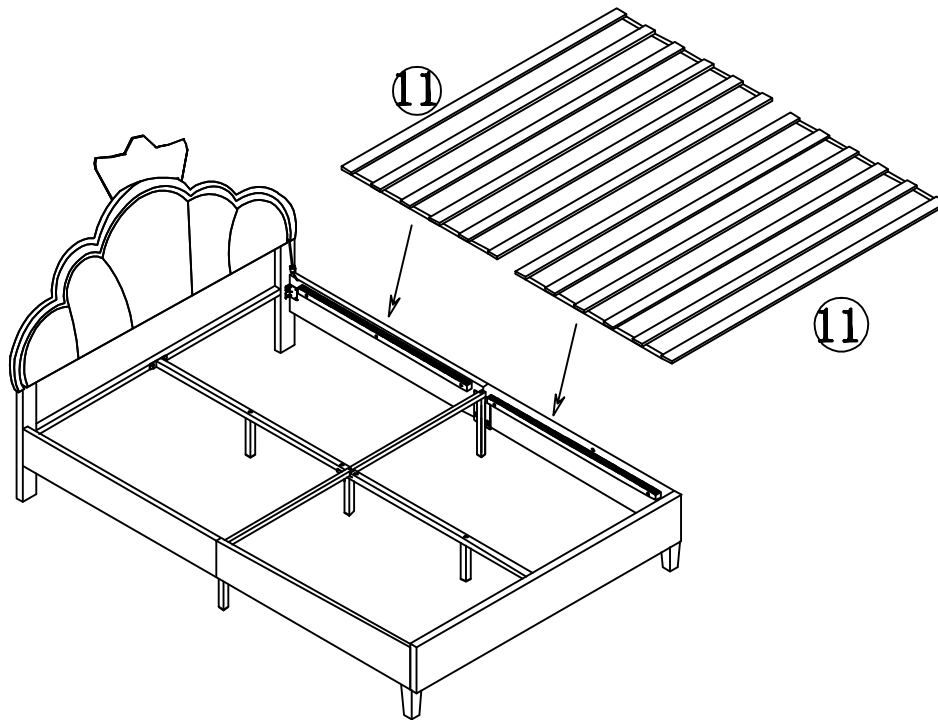

STEP 10

