

# Assembly Instructions

Please check that you have all the parts listed before you start assembling, if you do find that something is missing, do not continue assembly, please contact us immediately.

**NOTE:** Please do not completely tighten all the hardware until the entire assembly is complete!

## Bauanleitung

Bitte überprüfen Sie, ob alle Teile mitgeliefert sind, bevor Sie mit der Montage beginnen. Wenn Sie festlegen, dass etwas fehlt, setzen Sie die Montage nicht fort. Bitte kontaktieren Sie uns sofort.



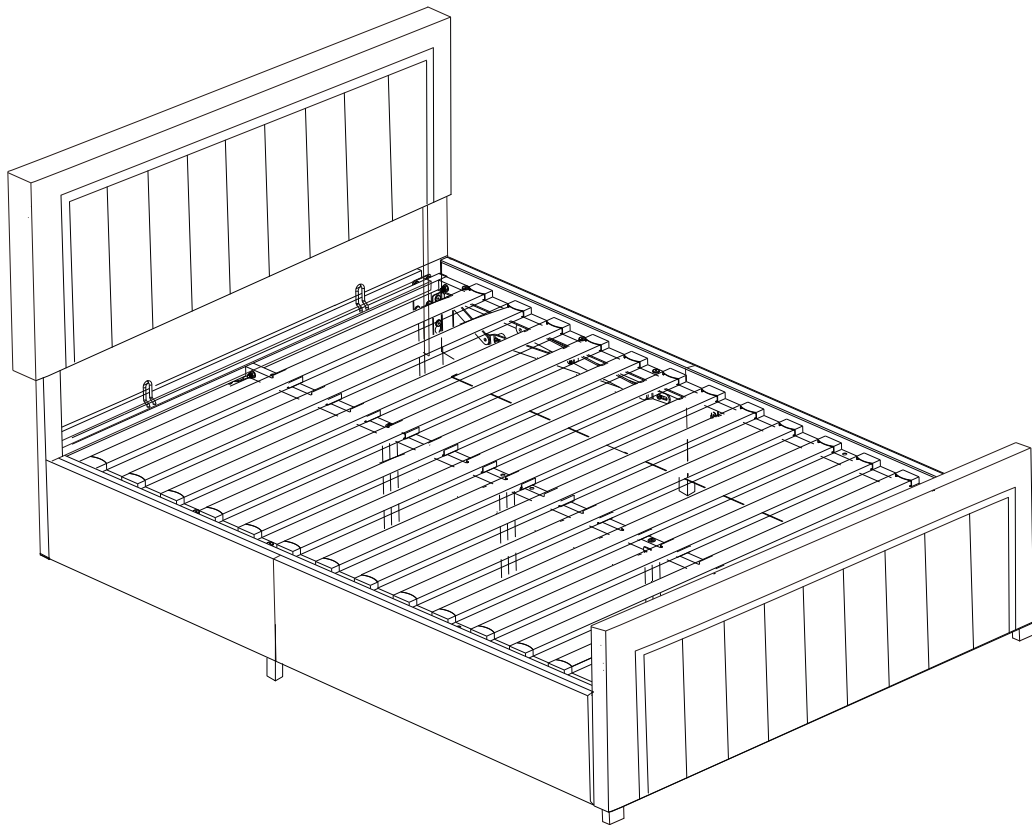



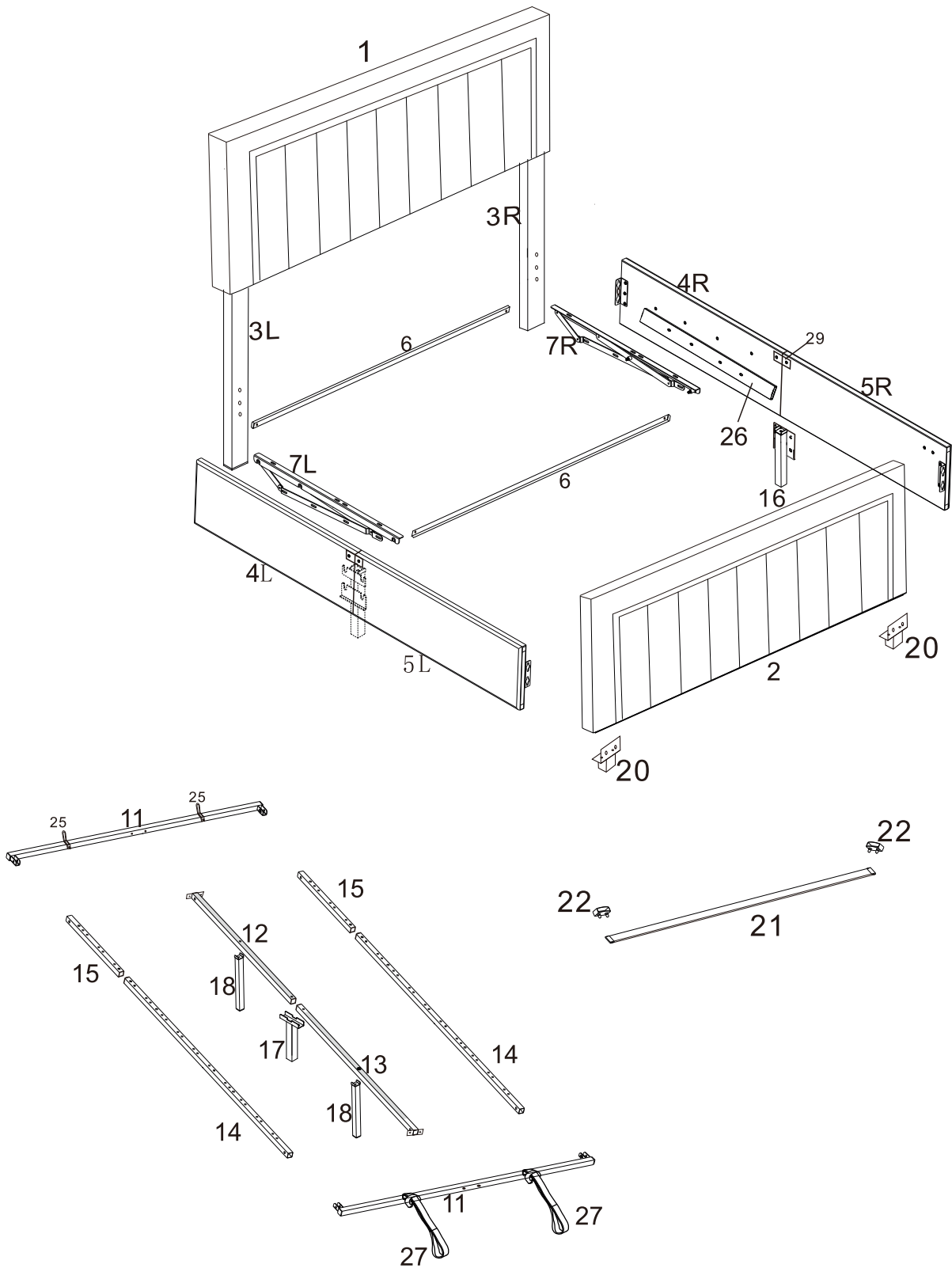



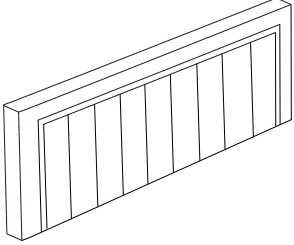
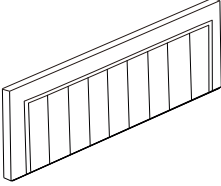

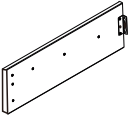
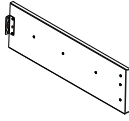
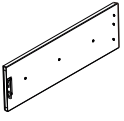
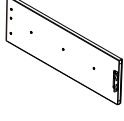
**Achtung:** Bitte ziehen Sie nicht alle Schrauben fest, bevor die Montage abgeschlossen ist!

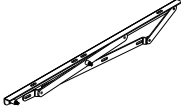
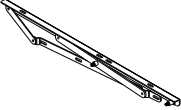
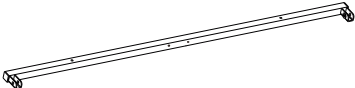
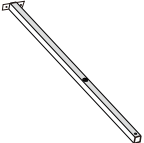
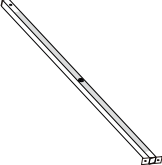
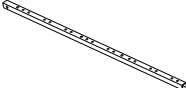
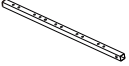
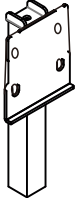
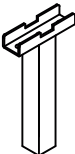
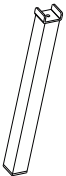
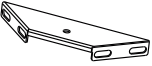



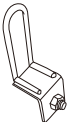







# Stückliste





# Part List-Stückliste

|   |   |   |  |   |   |
|---|---|---|--|---|---|
| <p>1</p>  <p>x1</p>    | <p>2</p>  <p>x1</p>    | <p>3L</p>  <p>x1</p>   | <p>3R</p>  <p>x1</p>    |   |   |
| <p>4L</p>  <p>x1</p>   | <p>4R</p>  <p>x1</p>   | <p>5L</p>  <p>x1</p>     | <p>5R</p>  <p>x1</p>      | <p>6</p>  <p>x2</p>    |   |
| <p>7L</p>  <p>x1</p>   | <p>7R</p>  <p>x1</p>   | <p>11</p>  <p>x2</p>   |  |   |   |
| <p>12</p>  <p>x1</p> | <p>13</p>  <p>x1</p> | <p>14</p>  <p>x2</p> |  |   |   |
| <p>15</p>  <p>x2</p> | <p>16</p>  <p>x2</p> | <p>17</p>  <p>x1</p> | <p>18</p>  <p>x2</p>  |   |   |
| <p>19</p>  <p>x2</p> | <p>20</p>  <p>x2</p> | <p>21</p>  <p>x12</p>  | <p>22</p>  <p>x24</p> | <p>23</p>   |   |
| <p>24</p>  <p>x1</p> | <p>25</p>  <p>x2</p> | <p>26</p>  <p>x2</p>   | <p>27</p>  <p>x2</p>    | <p>28</p>  <p>x1</p> | <p>29</p>  <p>x2</p> |

# Hardware List- Hardware-Liste

|   |  |  |  |
|---|--|--|--|
| <br>5/16x45mm<br><b>A*28 PCS</b> | <br>5/16*25MM<br><b>B*20PCS</b> | <br>1/4x35mm<br><b>C*8 PCS</b> | <br>1/4x15mm<br><b>D*20 PCS</b> |
| <br>Ø 19*5/16<br><b>E*66PCS</b>  | <br>Ø 16*1/4<br><b>F*28PCS</b>  | <br>5/16<br><b>G*18PCS</b>      | <br>1/4<br><b>H*1PS</b>         |
| <br>5/16<br><b>I*1PS</b>         | <br>5/16<br><b>J* 1PS</b>       |  |  |
|   |  |  |  |

## STEP 1

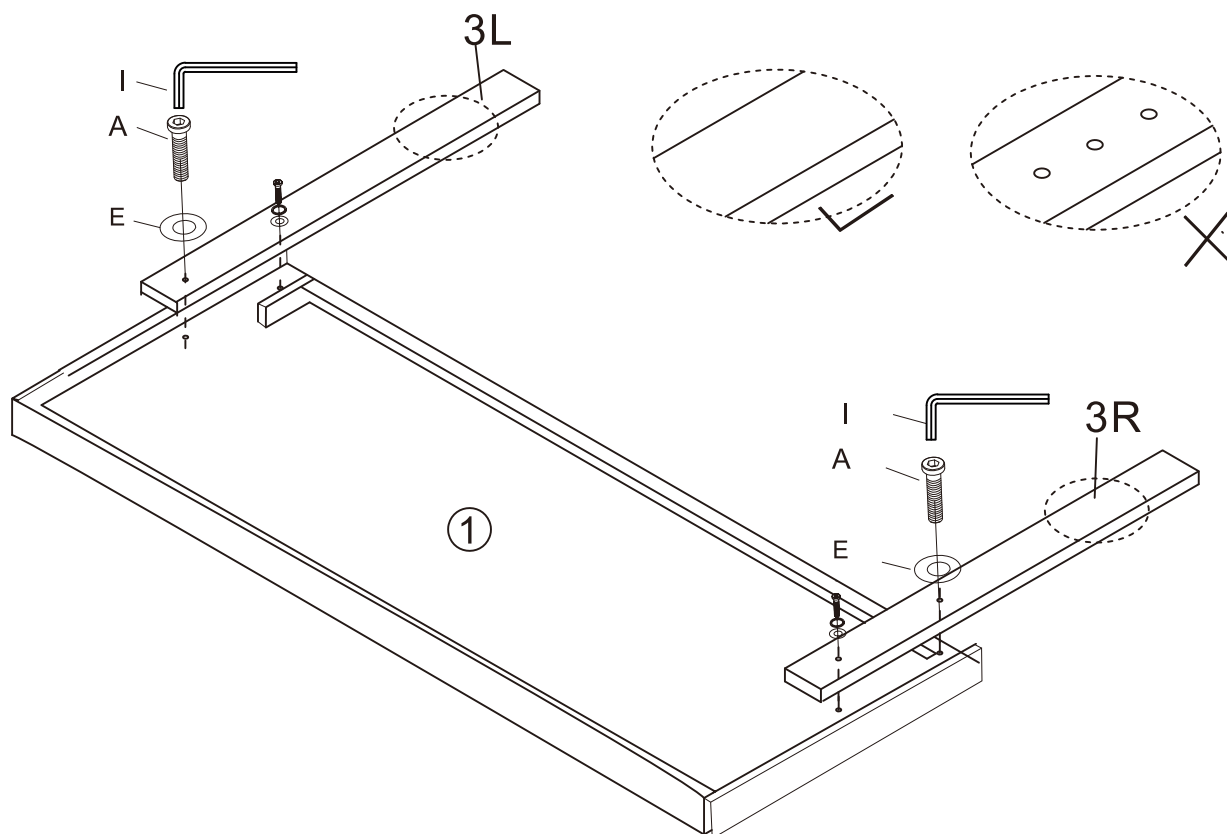

|   |   |  |
|---|---|--|
| <br>5/16*45mm<br><b>A * 4PCS</b> | <br>Ø 19*5/16<br><b>E* 4 PCS</b> | <br><b>I *1PS</b> |
|---|---|--|



Lassen Sie bitte die Seite mit 3 Löcher des #E nach unten.

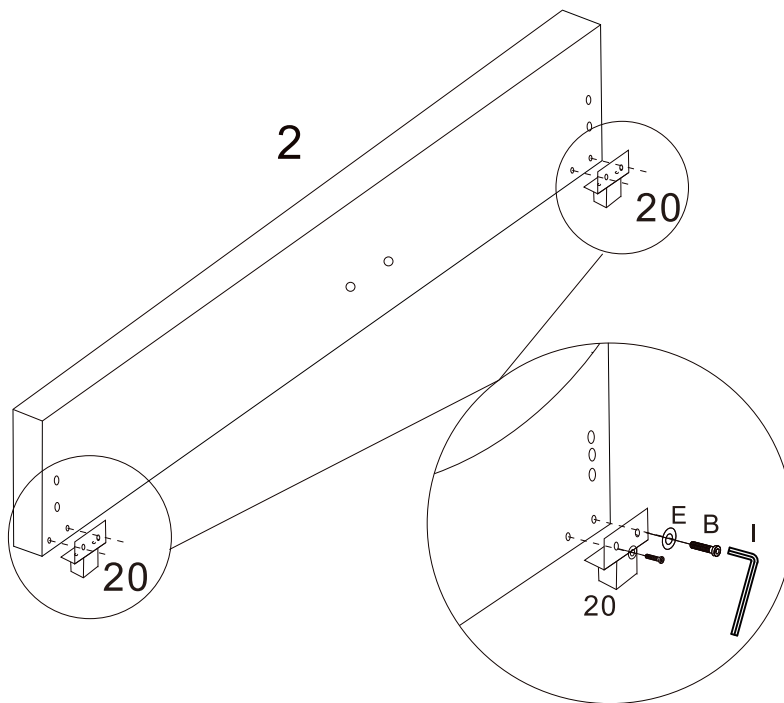

**STEP 2** Bitte lösen Sie zuerst die am Fußbrett vorinstallierten Schrauben, müssen diese aber nicht komplett herausdrehen.



|  |   |   |
|--|---|---|
| <br>5/16*25mm<br>B* 4PCS | <br>Ø 19*5/16<br>E* 4 PCS | <br>5/16<br>I*1PS |
|--|---|---|

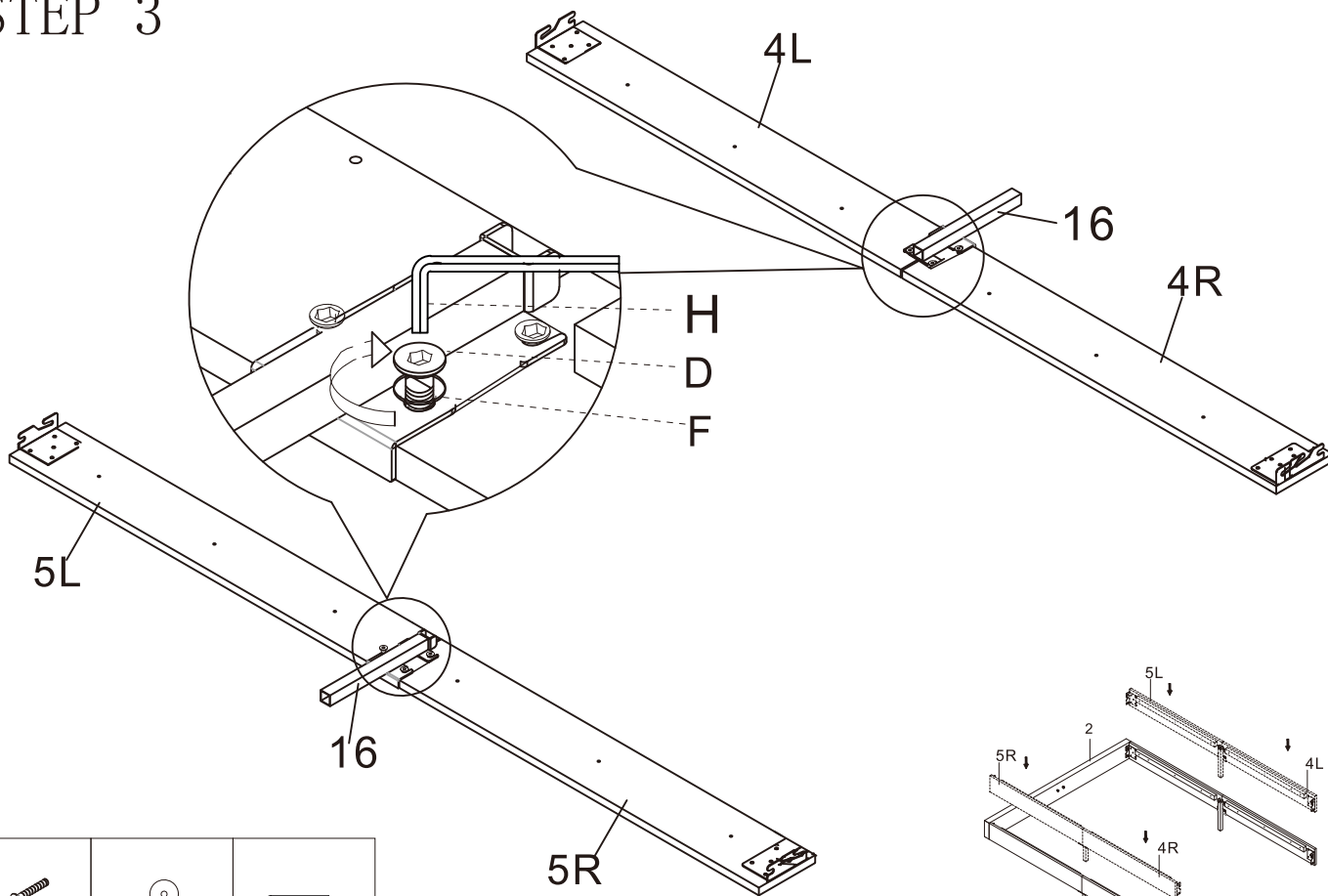



**STEP 3**

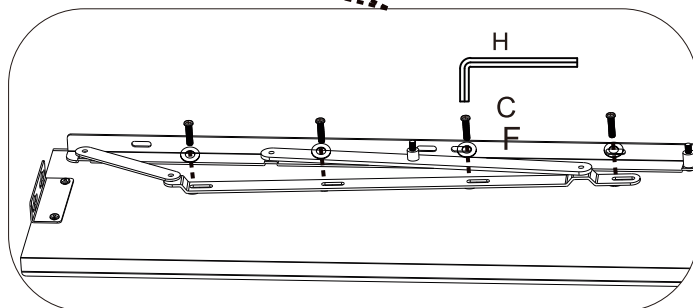
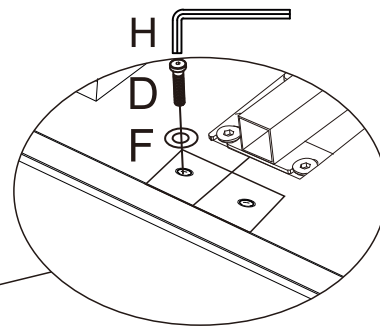
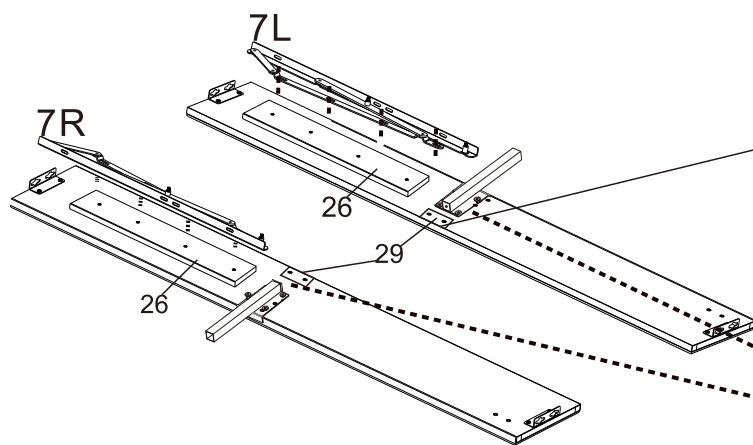

|   |   |   |
|---|---|---|
| <br>1/4*15mm<br>D*8PCS | <br>Ø 16*1/4<br>F*8PCS | <br>1/4<br>H*1PS |
|---|---|---|

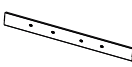

# STEP 4



|  |   |  |  |
|--|---|--|--|
| <br>1/4*15mm<br>D*4PCS  | <br>1/4<br>H*1PS         | <br>29<br>2PCS | <br>26<br>2PCS |
| <br>1/4*35mm<br>C*8PCS | <br>Ø 16*1/4<br>F*12PCS |  |  |

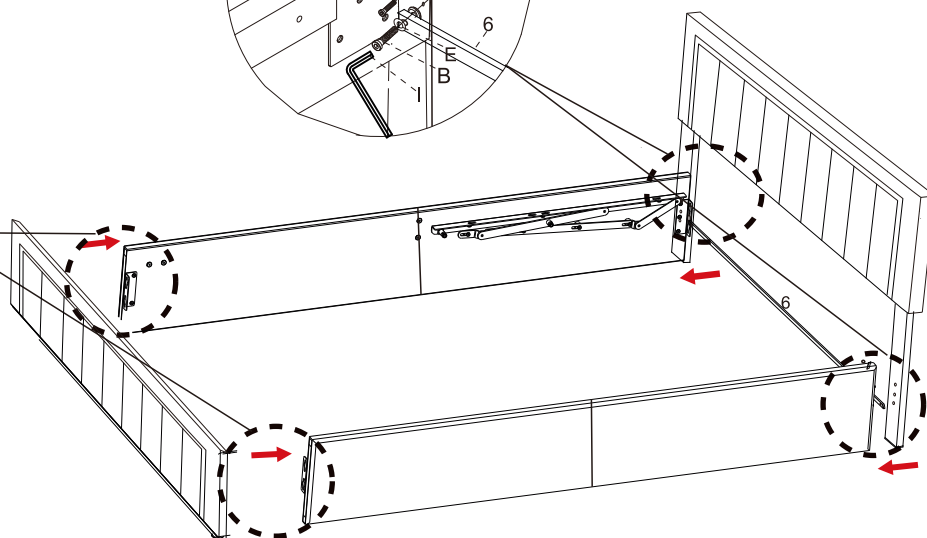
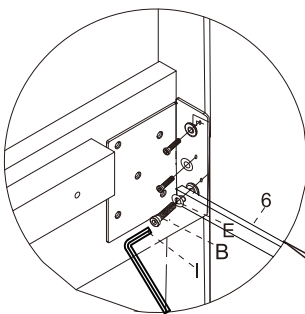
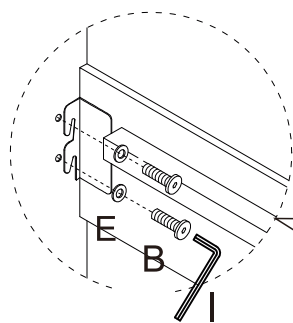





# STEP 5

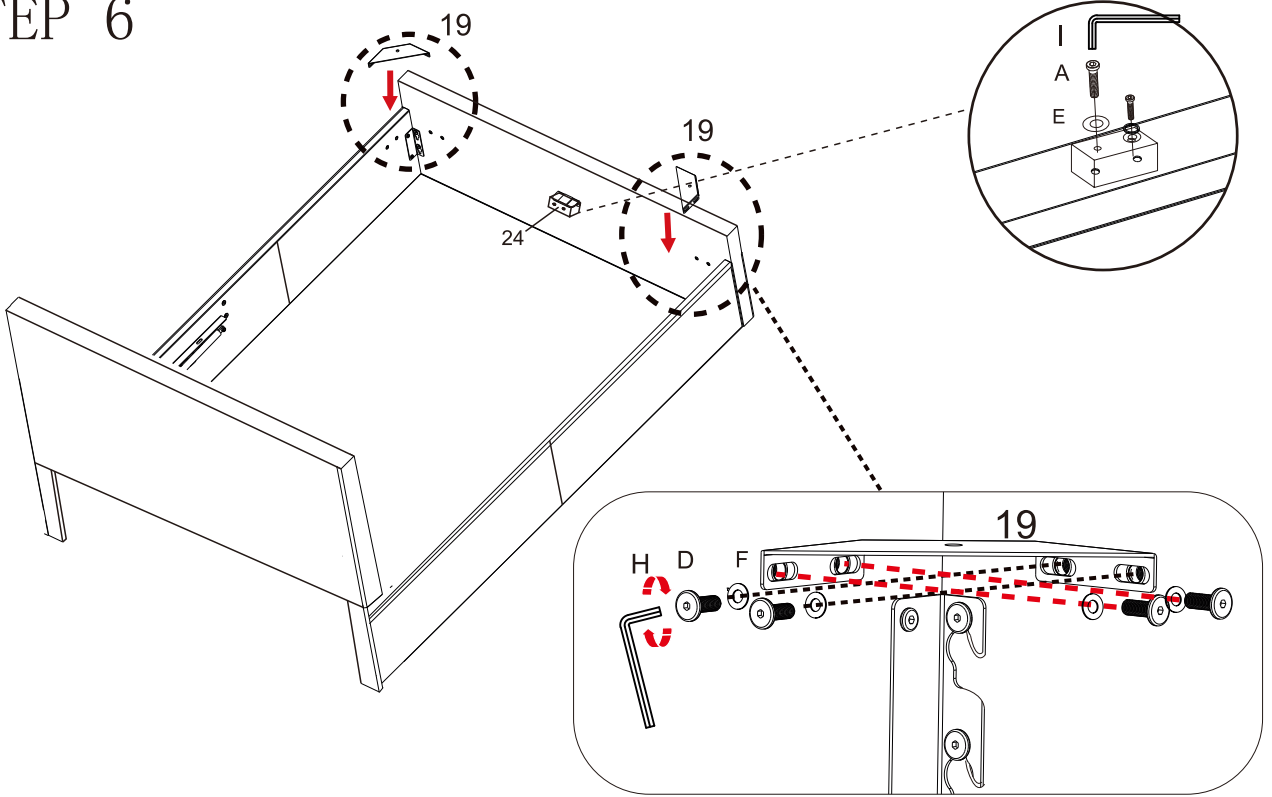

|   |   |  |
|---|---|--|
| <br>5/16*25mm<br>B*10PCS | <br>Ø 19*5/16<br>E*10PCS | <br>5/16<br>I*1PS |
|---|---|--|





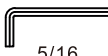

# STEP 6

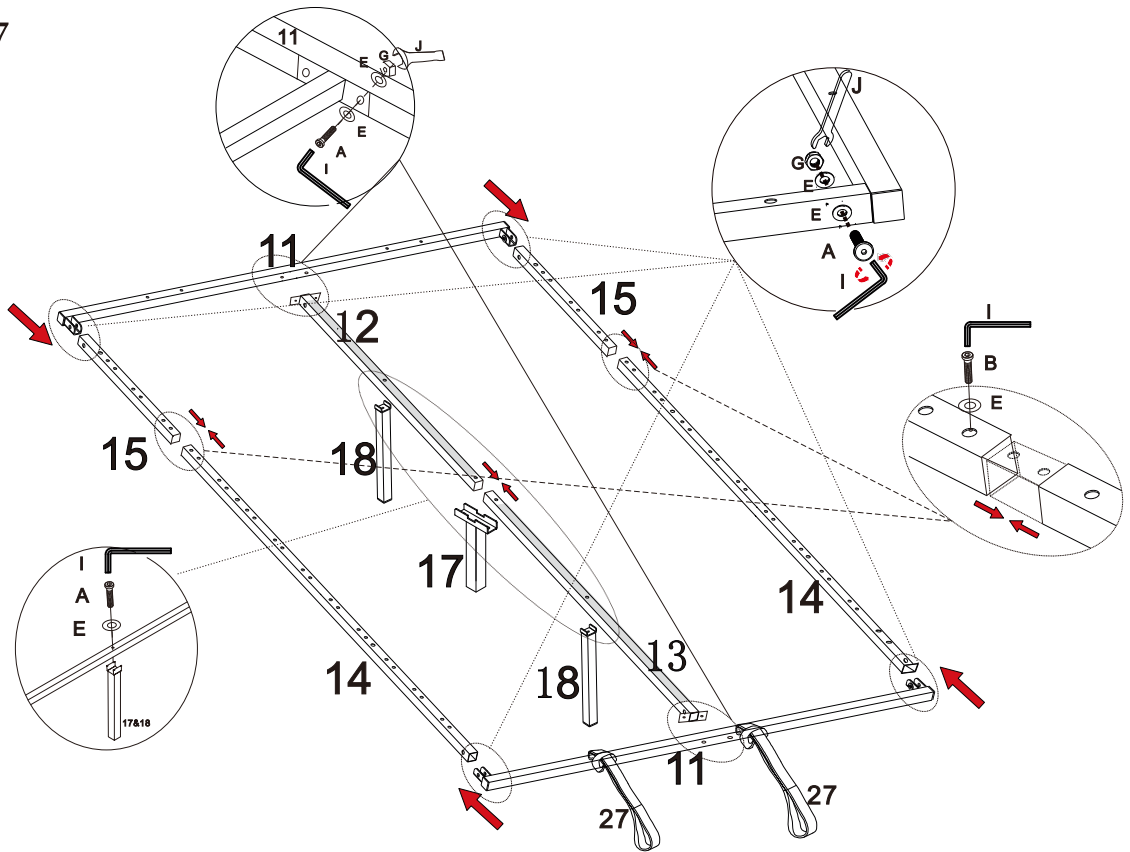

|  |  |   |  |   |  |  |  |
|--|--|---|--|---|--|--|--|
| <br>1/4*15mm | <br>Ø 16*1/4 | <br>1/4 | <br>5/16* 45mm | <br>Ø 19*5/16 | <br>19 X2 | <br>24 x 1 | <br>5/16 |
| D*8PCS   | F*8PCS   | H*1PS   | A*2 PCS  | E* 2 PCS  |  |  | I*1PS  |







# STEP 7

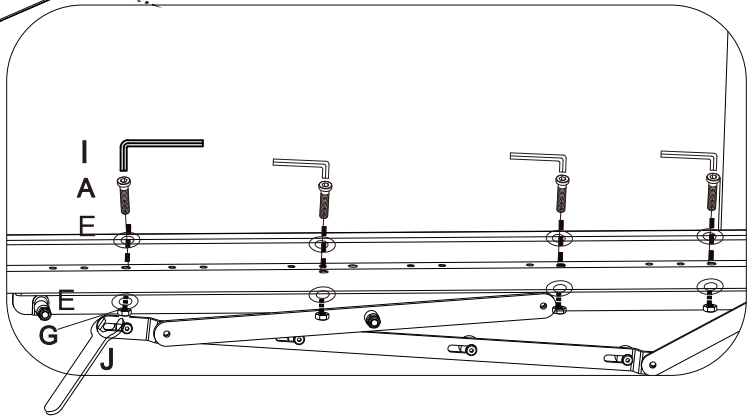
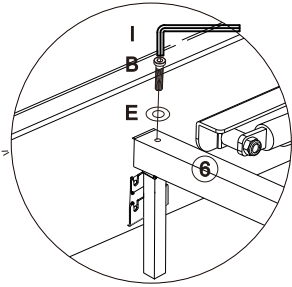
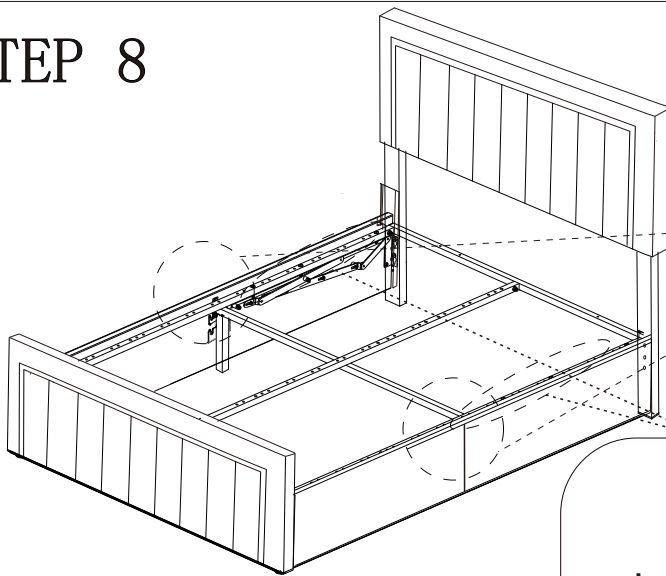

|  |  |  |  |  |  |
|--|--|--|--|--|--|
| <br>5/16*45mm | <br>Ø 19*5/16 | <br>I*1PS | <br>Gx8 | <br>J x 1 | <br>5/16*25mm |
| A*12PCS  | E*24PCS  |  | 5/16   |  | B* 4PCS  |







# STEP 8

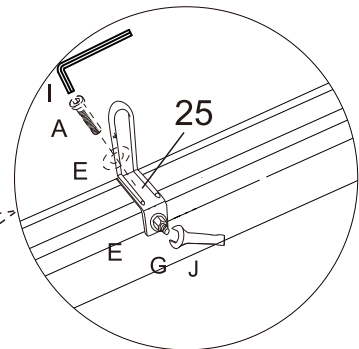
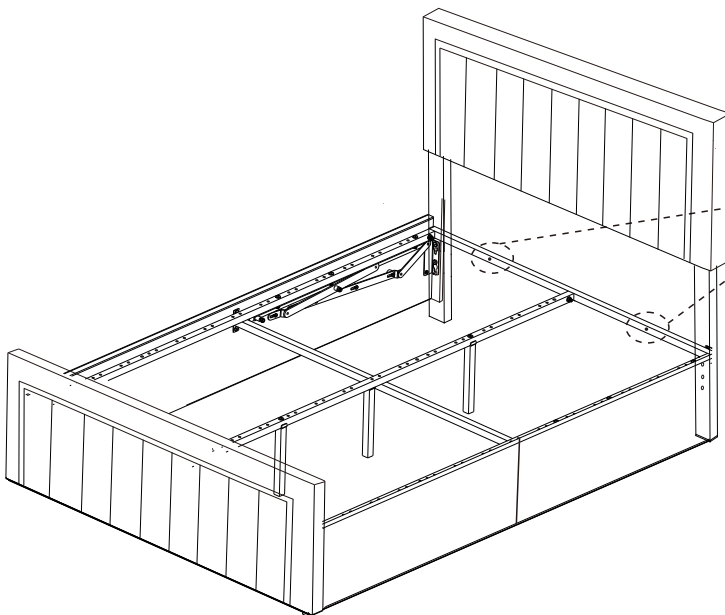

|  |   |  |   |  |  |
|--|---|--|---|--|--|
| <br>5/16*45mm<br>A * 8 PCS | <br>Ø 19*5/16<br>E*18PCS | <br>I *1PS | <br>G x8<br>5/16 | <br>J x1 | <br>5/16*25mm<br>B * 2 PCS |
|--|---|--|---|--|--|

# STEP 9



|   |  |   |   |   |  |
|---|--|---|---|---|--|
| <br>5/16*45mm<br>A * 2 PCS | <br>Ø 19*5/16<br>E* 4 PCS | <br>I *1PS | <br>G x2<br>5/16 | <br>J x1 | <br>25 x2 |
|---|--|---|---|---|--|



# STEP 10

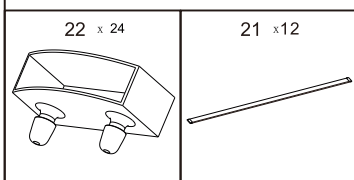
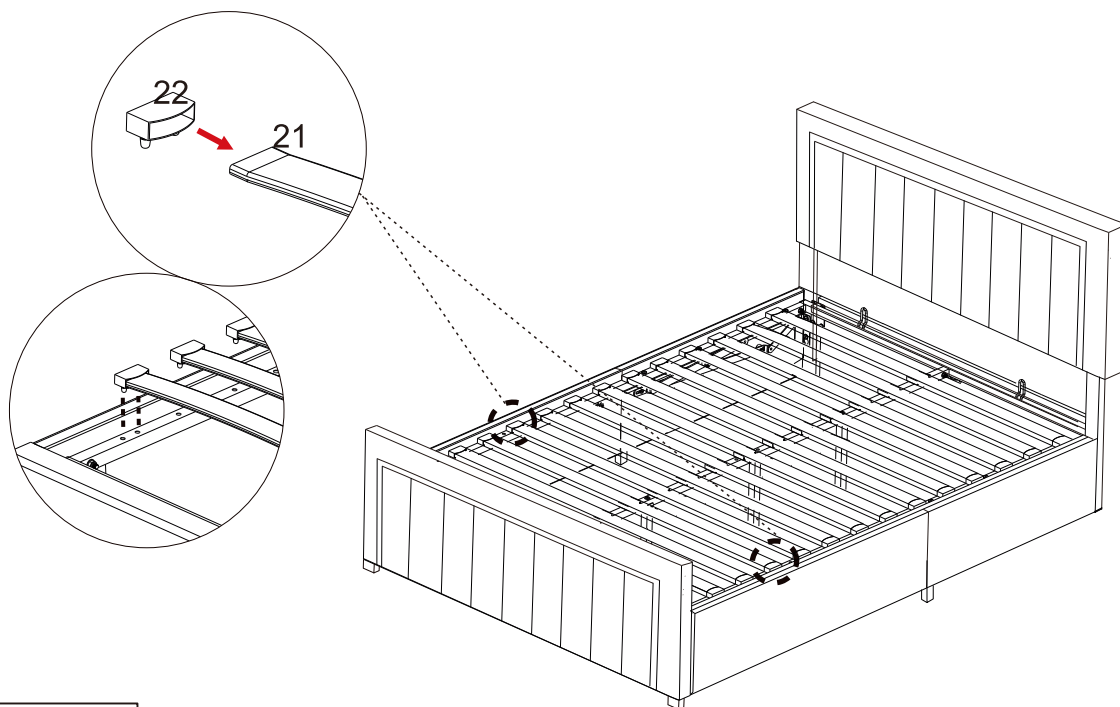

# STEP 11

